

# Altech Corp.®

Serving the Automation & Control Industry since 1984

Quality System



Quality  
Endorsed  
Company



## Interface Modules & Industrial Relays

12.7

3.5 3.5

12.7

7.5

20

2.5

# Altech Corp.®

Since 1984, Altech Corporation has grown to become a leading supplier of automation and industrial control components. Headquartered in Flemington, NJ, Altech has an experienced staff of engineering, manufacturing and sales personnel to provide the highest quality products with superior service. This is the Altech Commitment!







With experienced Product Engineers and Customer Service personnel, Altech provides solutions to your most pressing application challenges. All with one thought in mind - *to ensure that we solve your problem the first time!*



## Quality Commitment

*Altech's control components meet diverse national and international standards such as UL, NEC, CSA, IEC, VDE and more. Altech provides superior customer service and delivery through Total Quality Management and Continuous Process Improvement. Altech is ISO 9001 approved. We perform these services with honesty and integrity and are committed to achieve these goals.*



	<b>INTERFACE MODULES INTRODUCTION</b> .....	4-5
	<b>Connector to Terminal Block Modules</b> .....	6-9
	<b>Diode Modules &amp; Component Carriers</b> .....	10-14
	<b>Wire to RJ45 Module</b> .....	15
	<b>Interface Relay Modules and Carriers</b> .....	16-23
	<b>Interfaces, High Current Isolated</b> .....	24-27
	<b>Safety Relay Modules</b> .....	28-41
	<b>Interfaces</b> .....	42-45
	<b>PCB Mounting Tracks</b> .....	46-47
	<b>INDUSTRIAL RELAYS INTRODUCTION</b> .....	48-49
	<b>Industrial Electromagnetic Relays</b> .....	50-71
	<b>Miniature Electromagnetic Relays</b> .....	72-83
	<b>Slimline Interface Relays</b> .....	84-89
	<b>Subminiature Electromagnetic and Solid State Relays</b> .....	90-101
	<b>Relay Socket Combination</b> .....	104-109
	<b>Industrial Relay Accessories</b> .....	110-115
	<b>Index</b> .....	118-121
	<b>Terms &amp; Conditions</b> .....	122

# INTERFACE MODULES

Altech®



Link incompatible hardware or expand the capabilities of logic systems with Altech interface and electronic modules and carriers. These DIN Rail or panel mounted printed circuit board modules, subsystems and carriers give design flexibility, simplify panel layouts and reduce maintenance and downtime.

Altech's compact interface modules provide a flexible, cost effective transition from Sub-D, Ribbon Cable and other connectors to terminal blocks.

Altech's electronic modules include Diode, Fuse, Varistor, Optocoupler (I/O), Relay, power supplies and custom modules.

If your needs go beyond our comprehensive range of standard interface and electronic modules, Altech can custom design a module to meet even the most sophisticated requirements.

Modules are supplied completely assembled with ready to wire screw-cage terminal blocks in an extruded track. The track can be mounted on 35 or 32mm DIN Rail or can be panel mounted. Select individual components and mount your own electronic boards with Altech mounting tracks.

## CONNECTOR-TO-TERMINAL BLOCK

Compact and reliable transitions between high density connectors and high quality screw-cage clamp terminal blocks.

- FBK Ribbon Cable, up to 64 poles
- Subminiature - D, up to 50 poles



## MINIATURE RELAYS

Traditional relay and safety relay modules in a high density package.

- Protect equipment
- Provide insulation
- Control motors, solenoid and valves
- Safety relays for emergency stop, safety gate and two-hand stop



## DIODE MODULES & COMPONENT CARRIERS

Use our Diode Modules to build lamp test circuits, decouple signals, etc.

Mount your own components into our Component Carriers (supplied without electronic components). Or, tell us what you need and we'll install it for you.



- DM Diode Modules have series connection 1A or 3A diodes, and 1A diode gates with common cathodes or anodes, providing commonly used diode arrangements
- BSM Component Carrier has factory installed fork-and eyelet soldering posts in each series trace
- CCA Component Carrier consists of a printed circuit board with four in-line and two bus-connection through-holes to solder pads in each trace, complete with terminal blocks

## CUSTOM INTERFACE MODULES

If your design or application requires more functionality or features than our standard product, Altech offers complete engineering, prototype and production services for custom modules.

Our staff has the ability to take your design or requirements and manufacture your custom module. Custom module production generally includes engineering, PCB layout and prototypes, packaged in Altech extrusions for mounting on panels or DIN Rail. In many industrial control systems, customized designs are the solution for many problems.

Altech provides a quick turnaround and competitive solution to your problem.

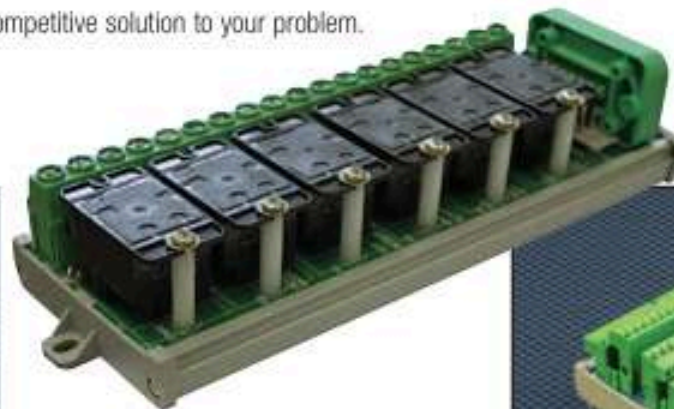

# CONNECTOR TO TERMINAL BLOCK MODULES

## INTERFACES CONNECTOR-TO-WIRE

### Ribbon Cable Module 35 or 32 mm DIN Rail

Compact Ribbon Connector Modules provide an interface between multi-wire flat cables outfitted with IDC connectors and discrete wires. Up to 64 conductors can be terminated saving time and eliminating wiring mistakes. No special wiring or tools are required. Ribbon Cable Interface Modules are typically used in communications, data processing, process control and other industrial applications. FBK Ribbon Cable Modules are supplied with short strain relief ejector latches (long ejector latches are available), screw-cage clamp terminal blocks and component solder pads for easy insertion of circuit building components. All terminal blocks are individually marked to correspond to the numbers on the header pins.

- Screw-Cage Clamp Connections
- Spring Clamp Connections Available
- Up to 64 Poles
- 4 to 5 Component Solder Pads Per Line
- .9mm (.035 in.) Diameter Component Mounting Holes
- DIN Rail Mount and Panel Mount Available

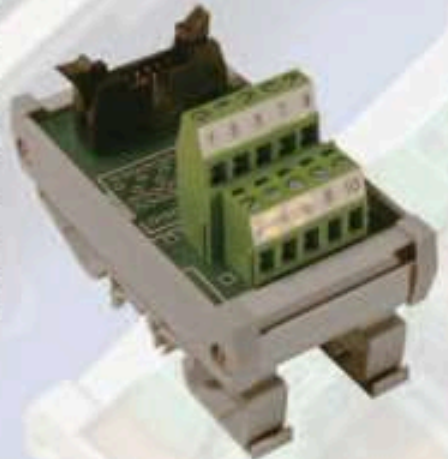

## INTERFACES CONNECTOR-TO-WIRE

### Subminiature D Module 35 or 32 mm DIN Rail

Compact Subminiature D (Sub D) Modules provide quick and reliable interfaces between high density connectors (back shells) with up to 50 poles and discrete wires. Connector-to-Wire Interface modules save time and eliminate wiring mistakes. No special tools are required. Sub D Interface modules are typically used in communications, data processing, process control and other industrial applications. Keyed by design, Sub D Modules are equipped with male or female connectors, screw-cage clamp terminal blocks, and component solder pads for easy insertion of circuit building components. All terminal blocks are individually marked to correspond to the numbers on the connector pins or sockets.

- Screw-Cage Clamp Connections
- Spring Clamp Connections Available
- 4 to 5 Component Solder Pads Per Line
- .9mm (.035 in.) Diameter Component Mounting Holes
- DIN Rail Mount, Panel Mount Available
- SD-F50 and SD-M50 are double-sided boards and do not have component solder pads.



# Interface Modules

## Connector to terminal block modules

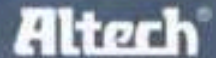

### INTERFACES CONNECTOR-TO-WIRE

#### Ribbon Cable Module

#### 35 or 32mm DIN Rail Mount

#### FBK

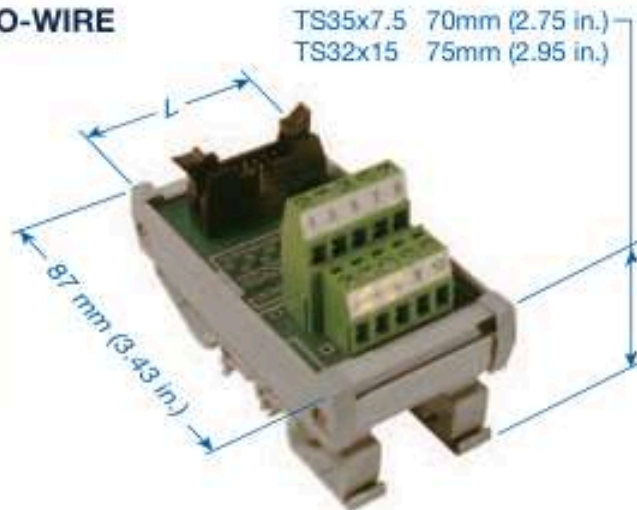

#### Technical Information

Current .....3 A  
 Voltage .....250V AC  
 Wire Range .....0.5-4 mm<sup>2</sup> / 22-12 AWG  
 Torque .....0.5-4 Nm / 4 lbs-in.  
 Stripping Length ...8 mm

#### SCREW CLAMP

Part Number	Type	No. of Poles	Module Length (L) in mm(in.)	Std. Pk.
5720.2	FBK10	10	46 (1.81)	1
5721.2	FBK14	14	46 (1.81)	1
5722.2	FBK16	16	68 (2.68)	1
5723.2	FBK20	20	68 (2.68)	1
5724.2	FBK26	26	80 (3.15)	1
5725.2	FBK34	34	93 (3.66)	1
5726.2	FBK40	40	114 (4.49)	1
5727.2	FBK50	50	139 (5.47)	1
5728.2	FBK60	60	180 (7.09)	1
5729.2	FBK64	64	180 (7.09)	1

#### SPRING CLAMP

Part Number	Type	No. of Poles	Module Length (L) in mm(in.)	Std. Pk.
5720.2/S	FBK10	10	46 (1.81)	1
5721.2/S	FBK14	14	46 (1.81)	1
5722.2/S	FBK16	16	68 (2.68)	1
5723.2/S	FBK20	20	68 (2.68)	1
5724.2/S	FBK26	26	80 (3.15)	1
5725.2/S	FBK34	34	93 (3.66)	1
5726.2/S	FBK40	40	114 (4.49)	1
5727.2/S	FBK50	50	139 (5.47)	1
5728.2/S	FBK60	60	180 (7.09)	1
5729.2/S	FBK64	64	180 (7.09)	1

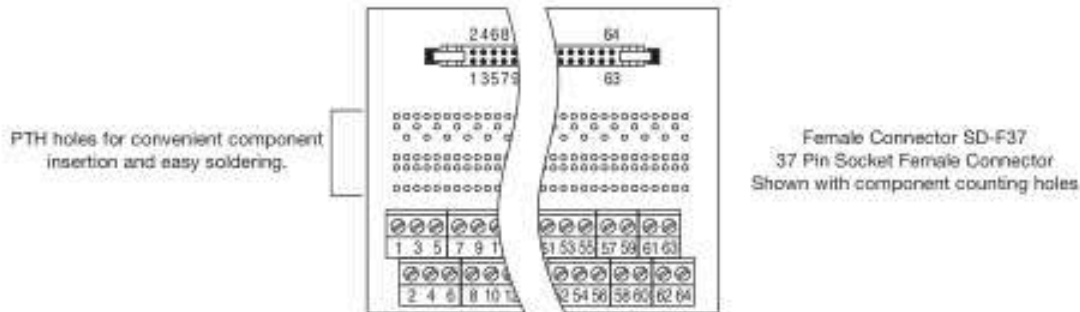

Other models available; please contact Altech.

Suffix .....Description	Suffix .....Description
none .....Screw Terminal; DIN Rail Mount	/L .....Screw Terminal; Long Latch Connector; DIN Rail Mount
/S .....Spring Terminal; DIN Rail Mount	/SL .....Spring Terminal; Long Latch Connector; DIN Rail Mount
/P .....Screw Terminal; Panel Mount	/SP .....Spring Terminal; Panel Mount

Example: Part Number 5727.2/L for Long Latch model.

# Interface Modules

## Connector to terminal block modules

### INTERFACES CONNECTOR-TO-WIRE

#### Subminiature SD Male Module

#### 35 or 32 mm DIN Rail Mount

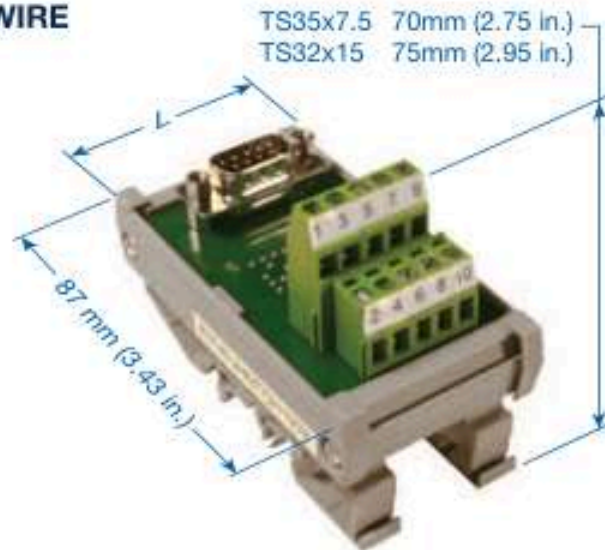

#### Technical Information

Current .....4 A  
 Voltage .....250V AC  
 Wire Range .....0.5-4 mm<sup>2</sup> / 22-12 AWG  
 Torque .....0.5-4 Nm / 4 lbs-in.  
 Stripping Length ...8 mm

#### SCREW CLAMP

Part Number	Type	No. of Poles	Module Length (L) in mm(in.)	Std. Pk.
5740.2	SD-M9	9	45 (1.77)	1
5741.2	SD-M15	15	53 (2.09)	1
5741.3*	HDSD-M15	15	53 (2.09)	1
5742.2	SD-M25	25	80 (3.15)	1
5743.2	SD-M37	37	113 (4.45)	1
5744.2 <sup>h</sup>	SD-M50	50	136 (5.35)	1

#### SPRING CLAMP

Part Number	Type	No. of Poles	Module Length (L) in mm(in.)	Std. Pk.
5740.2/S	SD-M9	9	45 (1.77)	1
5741.2/S	SD-M15	15	53 (2.09)	1
5741.3/S*	HDSD-M15	15	53 (2.09)	1
5742.2/S	SD-M25	25	80 (3.15)	1
5743.2/S	SD-M37	37	113 (4.45)	1
5744.2/S <sup>h</sup>	SD-M50	50	136 (5.35)	1

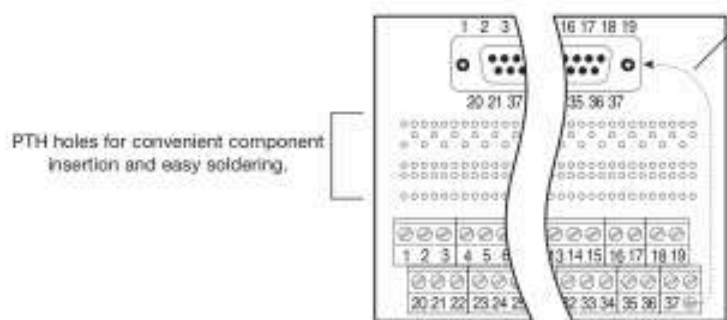

Female Connector SD-F37  
 37 Pin Socket Female Connector  
 Shown with component counting holes  
 (pads are on solder side)

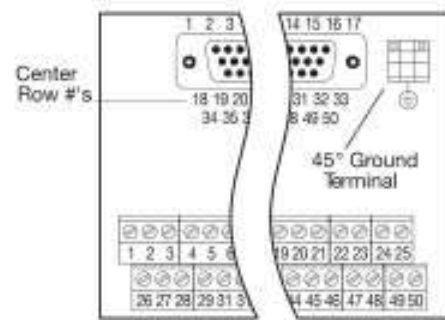

Female Connector SD-F50  
 50 Pin Socket Female Connector  
 Shown with no component solder pads

Other models available; please contact Altech.

Suffix .....Description  
 none .....Screw Terminal; DIN Rail Mount  
 /S .....Spring Terminal; DIN Rail Mount  
 /P .....Screw Terminal; Panel Mount

Suffix .....Description  
 /L .....Screw Terminal; Long Latch Connector; DIN Rail Mount  
 /SL .....Spring Terminal; Long Latch Connector; DIN Rail Mount  
 /SP .....Spring Terminal; Panel Mount

Example: Part Number 5727.2/L for Long Latch model.

\* High density version.

<sup>h</sup> SD-M50 is only available with a 1.5A current rating.

<sup>h</sup> SD-F50 and SD-M50 are double-sided boards and do not have component solder pads.

### INTERFACES CONNECTOR-TO-WIRE

#### Subminiature SD Female Module

#### 35 or 32 mm DIN Rail Mount

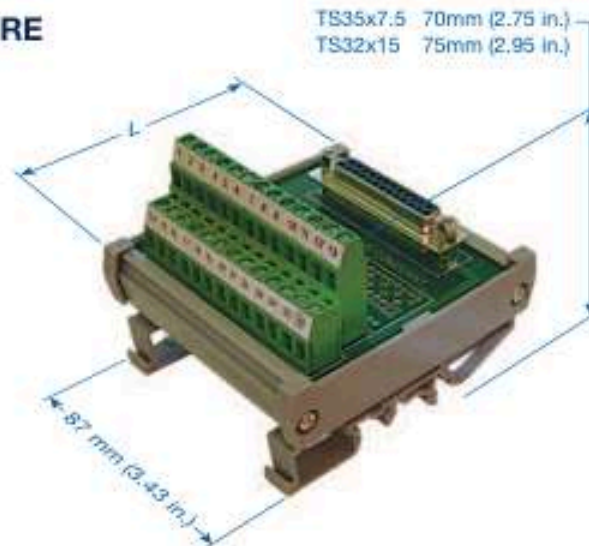

#### Technical Information

Current .....4 A  
 Voltage .....250V AC  
 Wire Range .....0.5-4 mm<sup>2</sup> / 22-12 AWG  
 Torque .....0.5-4 Nm / 4 lbs-in.  
 Stripping Length ...8 mm

#### SCREW CLAMP

Part Number	Type	No. of Poles	Module Length (L) in mm(in.)	Std. Pk.
5745.2	SD-F9	9	45 (1.77)	1
5746.2	SD-F15	15	49 (1.93)	1
5746.3*	HDSD-F15	15	49 (1.93)	1
5747.2	SD-F25	25	80 (3.15)	1
5748.2	SD-F37	37	113 (4.45)	1
5749.2 <sup>ab</sup>	SD-F50	50	136 (5.35)	1

#### SPRING CLAMP

Part Number	Type	No. of Poles	Module Length (L) in mm(in.)	Std. Pk.
5745.2/S	SD-F9	9	45 (1.77)	1
5746.2/S	SD-F15	15	49 (1.93)	1
5746.3/S*	HDSD-F15	15	49 (1.93)	1
5747.2/S	SD-F25	25	80 (3.15)	1
5748.2/S	SD-F37	37	113 (4.45)	1
5749.2/S <sup>ab</sup>	SD-F50	50	136 (5.35)	1

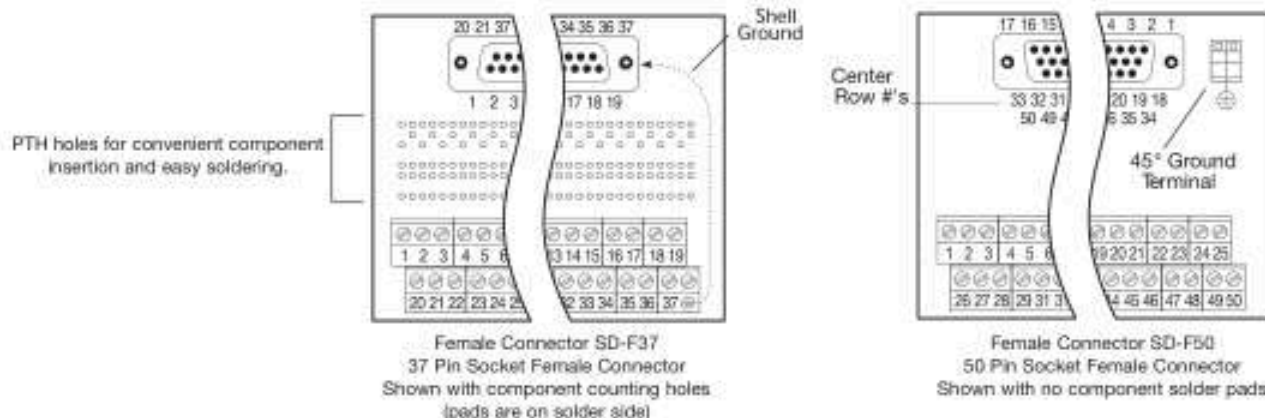

Other models available; please contact Altech.

Suffix .....Description  
 none .....Screw Terminal; DIN Rail Mount  
 /S .....Spring Terminal; DIN Rail Mount  
 /P .....Screw Terminal; Panel Mount

Suffix .....Description  
 /L .....Screw Terminal; Long Latch Connector; DIN Rail Mount  
 /SL .....Spring Terminal; Long Latch Connector; DIN Rail Mount  
 /SP .....Spring Terminal; Panel Mount

Example: Part Number 5727.2/L for Long Latch model.

\* High density version.

<sup>a</sup> SD-M50 is only available with a 1.5A current rating.

<sup>b</sup> SD-F50 and SD-M50 are double-sided boards and do not have component solder pads.

# DIODE MODULES & COMPONENT CARRIERS

## INTERFACES

### DM Diode Module

#### 35 or 32mm DIN Rail Mount

Wire individually labeled diodes into existing circuits for freewheeling, DC inductive kick suppression (commutating), reverse DC polarity protection, etc. Use bussed diodes for distribution of logic Vcc or ground, or gather and decouple electrical signals for lamp testing or collective fault messages. Use as commutating diodes across inductive loads such as DC relays, solenoid valves, actuator magnets, etc. to suppress voltage surges.

Standard modules include series connection diode circuits in 1 Amp and 3 Amp versions, and diode gates with bussed anodes or cathodes.

- Screw-Cage Clamp Connections
- Special Configurations Available
- DIN Rail Mount, Panel Mount Available

## INTERFACES

### Component Carriers

#### 35 or 32mm DIN Rail

Use Component Carriers to modify and/or build circuits to meet special requirements. Type CCA requires removal of the single solder-side printed circuit board from the mounting track for soldering of components. Posts or through-leads can be installed for future field connections. Contact Altech for custom installation of solder posts. Type BSM allows field additions of diodes for decoupling, line crossovers for testing or multiplying tie-in terminals for a line. Pre-installed flat, fork-and-eyelet soldering posts allow component-side mechanical and solder connections with minimum disruption to wiring and mounted devices.

- Screw-Cage Clamp Connections
- Terminal Blocks are Numbered for Easy Wire Identification
- DIN Rail Mount, Panel Mount Available

## INTERFACES

### Dip Socket Carrier - 3 Amp

#### 35 or 32mm DIN Rail Mount

Enhance design capabilities with Dual In-Line Package (DIP) Socket Carriers, the most versatile socket available. Use our DIPCs for reed-relays, power relays, photo-isolated Input/Output modules, in-line switches, thin film resistors and more. The Altech DIPC is rated 3 Amp and is available in 14, 16 and 20 pin socket configurations. Each DIPC module has several component solder pads for loading circuit-building components.

- Screw-Cage Clamp Connections
- 4 to 5 Component Solder Pads Per Line
- .9mm (.035 in.) Diameter Component Mounting Holes
- DIN Rail Mount, Panel Mount Available

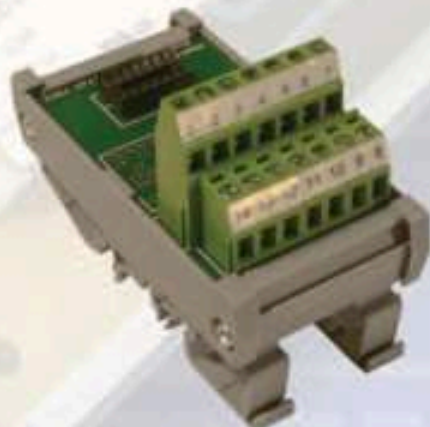
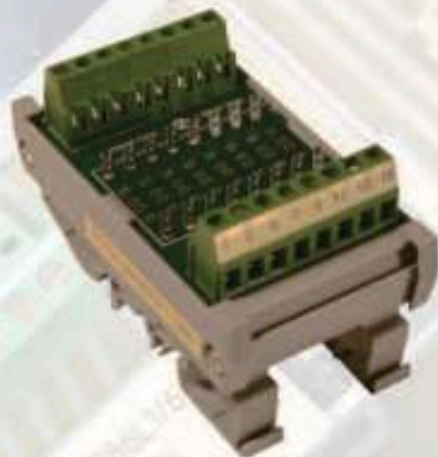
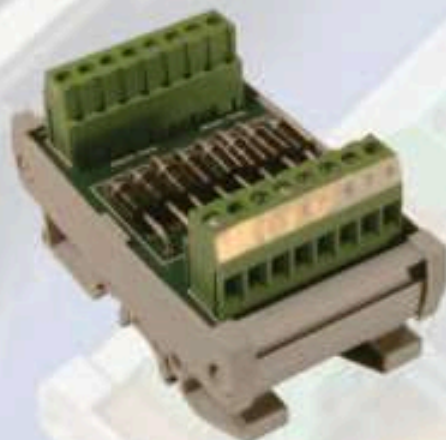

### INTERFACES

#### DM Diode Module

#### 35 or 32 mm DIN Rail Mount

##### Technical Information

Diode	Rated Current
1N4007 or equivalent	1A
1N5408 or equivalent	3A
P600M or equivalent	6A

Maximum Blocking Voltage - 1000V DC  
 Rated Bus Current: 10A  
 (12A at 30°C (86°F) Temperature Rise)  
 Wire Range .....0.5-4 mm<sup>2</sup>; 22-12 AWG  
 Voltage .....250V AC  
 Torque .....0.5-4 Nm / 4 lbs-in.  
 Stripping Length ...8 mm

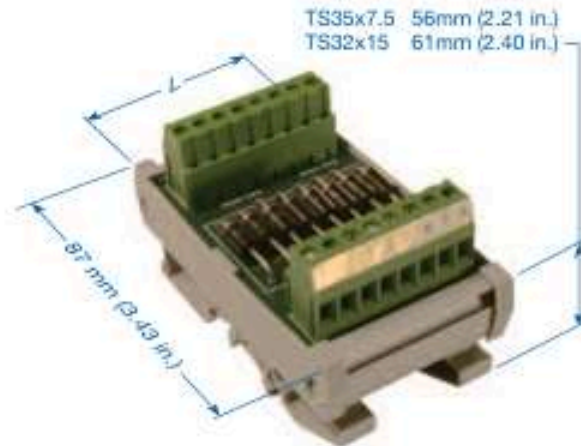

### SCREW CLAMP \*

#### 1 AMP

Part Number	Type	Ordering Information	No. of Diodes	Diode	Module Length (L) in mm(in.)	Std. Pk.	Figure
8971.2	DM4-S	Series Connection, 1A diodes	4	1N4007	24 (0.95)	1	A
5702.2	DM8-S	Series Connection, 1A diodes	8	1N4007	44 (1.73)	1	A
5703.2	DM12-S	Series Connection, 1A diodes	12	1N4007	64 (2.52)	1	A
8973.2	DM16-S	Series Connection, 1A diodes	16	1N4007	92 (3.62)	1	A
8974.2	DM20-S	Series Connection, 1A diodes	20	1N4007	112 (4.41)	1	A
8975.2	DM24-S	Series Connection, 1A diodes	24	1N4007	132 (5.20)	1	A
8842.2	DM6-A-S	Bussed Anodes, 1A diodes	6	1N4007	30 (1.18)	1	B
5704.2	DM14-A-S	Bussed Anodes, 1A diodes	14	1N4007	50 (1.97)	1	B
5705.2	DM22-A-S	Bussed Anodes, 1A diodes	22	1N4007	70 (2.75)	1	B
8850.2	DM6-K-S	Bussed Cathodes, 1A diodes	6	1N4007	30 (1.18)	1	C
5706.2	DM14-K-S	Bussed Cathodes, 1A diodes	14	1N4007	50 (1.97)	1	C
5707.2	DM22-K-S	Bussed Cathodes, 1A diodes	22	1N4007	70 (2.75)	1	C

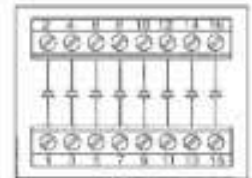

DM8-S  
Figure A

#### 3 AMP

Part Number	Type	Ordering Information	No. of Diodes	Diode	Module Length (L) in mm(in.)	Std. Pk.	Figure
8971.3	DM4-S3	Series Connection, 3A diodes	4	1N5408	24 (0.95)	1	A
5702.3	DM8-S3	Series Connection, 3A diodes	8	1N5408	44 (1.73)	1	A
5703.3	DM12-S3	Series Connection, 3A diodes	12	1N5408	64 (2.52)	1	A
8973.3	DM16-S3	Series Connection, 3A diodes	16	1N5408	92 (3.62)	1	A
8974.3	DM20-S3	Series Connection, 3A diodes	20	1N5408	112 (4.41)	1	A
8975.3	DM24-S3	Series Connection, 3A diodes	24	1N5408	132 (5.20)	1	A
8842.3	DM6-A-S3	Bussed Anodes, 3A diodes	6	1N5408	30 (1.18)	1	B
5704.3	DM14-A-S3	Bussed Anodes, 3A diodes	14	1N5408	50 (1.97)	1	B
5705.3	DM22-A-S3	Bussed Anodes, 3A diodes	22	1N5408	70 (2.75)	1	B
8850.3	DM6-K-S3	Bussed Cathodes, 3A diodes	6	1N5408	30 (1.18)	1	C
5706.3	DM14-K-S3	Bussed Cathodes, 3A diodes	14	1N5408	50 (1.97)	1	C
5707.3	DM22-K-S3	Bussed Cathodes, 3A diodes	22	1N5408	70 (2.75)	1	C

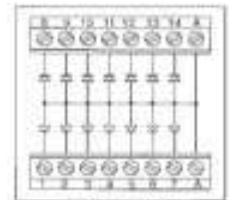

DM14-A-S  
Figure B

#### 6 AMP

Part Number	Type	Ordering Information	No. of Diodes	Diode	Module Length (L) in mm(in.)	Std. Pk.	Figure
8971.4	DM4-S6	Series Connection, 6A diodes	4	P600M	24 (0.95)	1	A
5702.4	DM8-S6	Series Connection, 6A diodes	8	P600M	44 (1.73)	1	A
5703.4	DM12-S6	Series Connection, 6A diodes	12	P600M	64 (2.52)	1	A
8973.4	DM16-S6	Series Connection, 6A diodes	16	P600M	92 (3.62)	1	A
8974.4	DM20-S6	Series Connection, 6A diodes	20	P600M	112 (4.41)	1	A
8975.4	DM24-S6	Series Connection, 6A diodes	24	P600M	132 (5.20)	1	A
8842.4	DM6-A-S6	Bussed Anodes, 6A diodes	6	P600M	30 (1.18)	1	B
5704.4	DM14-A-S6	Bussed Anodes, 6A diodes	14	P600M	50 (1.97)	1	B
5705.4	DM22-A-S6	Bussed Anodes, 6A diodes	22	P600M	70 (2.75)	1	B
8850.4	DM6-K-S6	Bussed Cathodes, 6A diodes	6	P600M	30 (1.18)	1	C
5706.4	DM14-K-S6	Bussed Cathodes, 6A diodes	14	P600M	50 (1.97)	1	C
5707.4	DM22-K-S6	Bussed Cathodes, 6A diodes	22	P600M	70 (2.75)	1	C

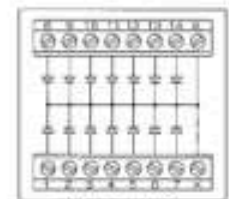

DM14-K-S  
Figure C

\* Spring Terminal is available; add suffix S to end of part number. Example: Part Number 8971.2/S for Spring Terminal.

# Interface Modules

## Diode modules & component carriers

### INTERFACES

#### CCA Component Carrier 35 or 32 mm DIN Rail Mount with PTH holes

##### Technical Information

Current .....6 A (12 A Bus)  
Terminal.....15 A  
Voltage .....250V AC  
Wire Range .....0.5-4 mm<sup>2</sup> / 22-12 AWG  
Torque .....0.5-4 Nm / 4 lbs-in.  
Stripping Length ...8 mm

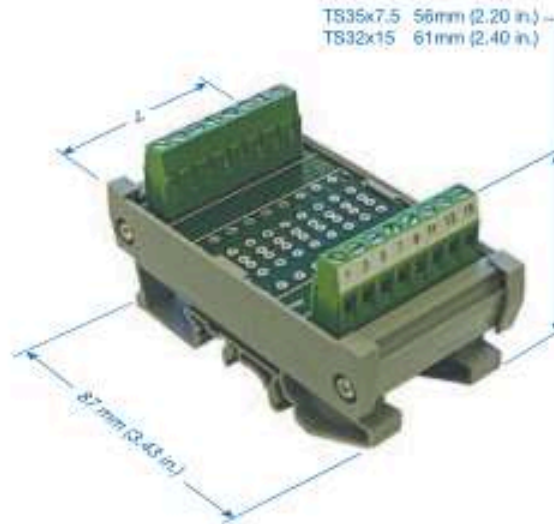

#### SCREW CLAMP

Part Number	Type	No. of Poles	Module Length (L) in mm(in.)	Std. Pk.
8835.2	CCA4	4	24 (.87)	1
8836.2	CCA8	8	44 (1.65)	1
8837.2	CCA12	12	64 (2.44)	1
8838.2	CCA16	16	84 (3.23)	1
8839.2	CCA20	20	104 (4.02)	1
8840.2	CCA24	24	124 (4.80)	1

#### SPRING CLAMP

Part Number	Type	No. of Poles	Module Length (L) in mm(in.)	Std. Pk.
8835.2/S	CCA4	4	24 (.87)	1
8836.2/S	CCA8	8	44 (1.65)	1
8837.2/S	CCA12	12	64 (2.44)	1
8838.2/S	CCA16	16	84 (3.23)	1
8839.2/S	CCA20	20	104 (4.02)	1
8840.2/S	CCA24	24	124 (4.80)	1

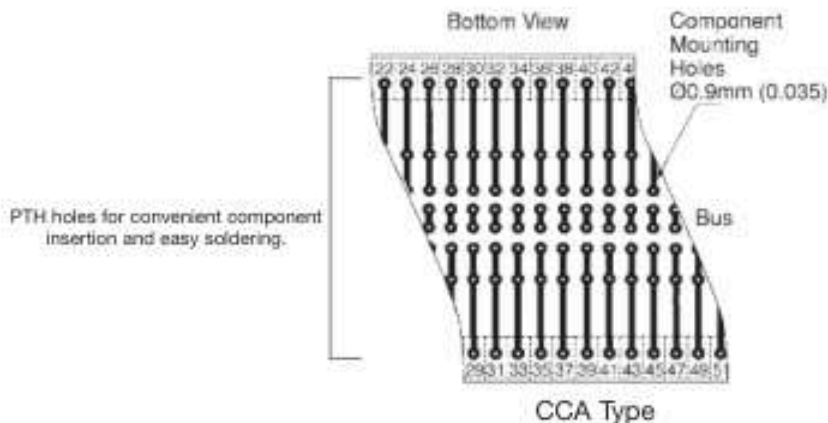

CCA Type

### INTERFACES

#### BSM Component Carrier 35 or 32 mm DIN Rail Mount with solder posts

##### Technical Information

Current.....6 A (12 A Bus)  
Terminal.....15 A  
Voltage.....250V AC  
Wire Range.....0.5-4 mm<sup>2</sup> / 22-14 AWG  
Torque.....0.5-4 Nm / 4 lbs-in.  
Stripping Length...8 mm

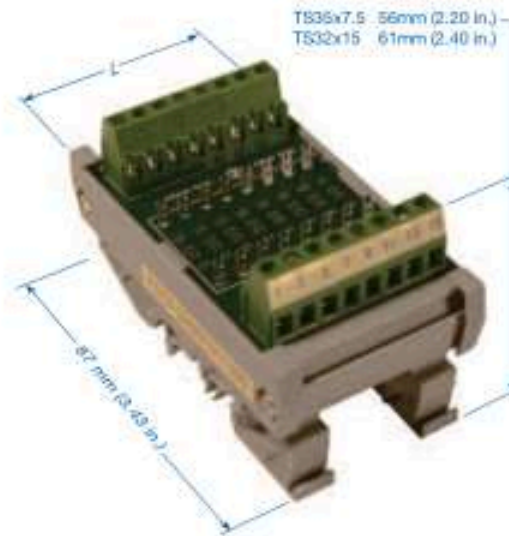

#### SCREW CLAMP

Part Number	Type	No. of Poles	Module Length (L) in mm(in.)	Std. Pk.
5700.2	BSM8-S	16	47 (1.85)	1
5701.2	BSM12-S	24	69 (2.72)	1

#### SPRING CLAMP

Part Number	Type	No. of Poles	Module Length (L) in mm(in.)	Std. Pk.
5700.2/S	BSM8-S	16	47 (1.85)	1
5701.2/S	BSM12-S	24	69 (2.72)	1

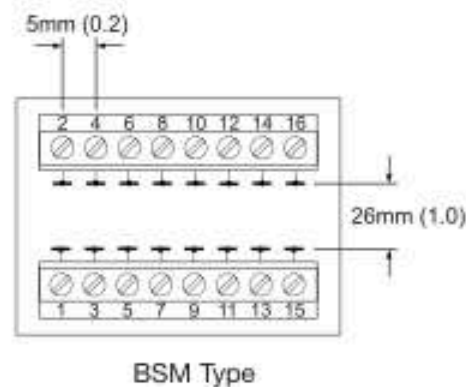
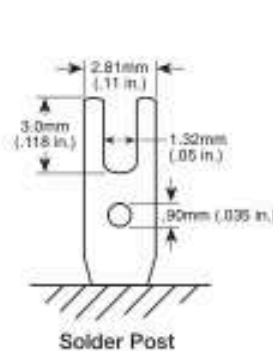

# Interface Modules

## Diode modules & component carriers

### INTERFACES

#### Dip Socket Carrier - 3 Amp 35 or 32mm DIN Rail Mount

##### Typical Applications:

14 Pin

Magnecraft® Classes 107, 171, 172;  
S-D® Series MRR-D; Hamlin® 700;  
Dale® TDP14 Resistors; etc.

16 Pin

Most P&B® including T85 Hi Sens and  
I/O Modules IA, OA, OD16;  
Midtex® 190 Power;

Augat® Alcoswitch® GD, AD Series, etc.

20 Pin

C&K® BD series switches;

Grayhill® 79 coded switches;

AMP® 7600 shunts; etc.

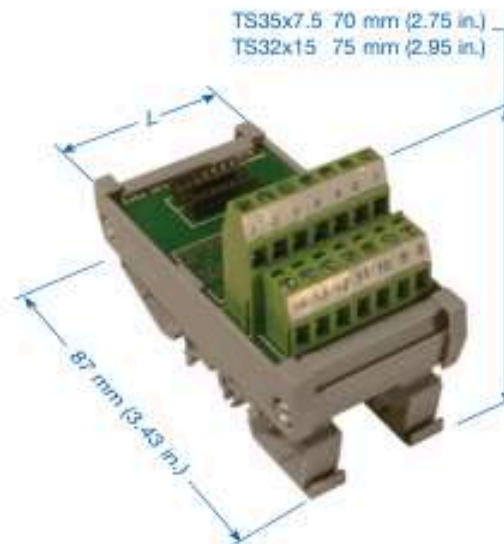

#### Technical Information

Current .....3 A<sup>1</sup>  
Voltage .....250V AC  
Wire Range .....0.5-4 mm<sup>2</sup> / 22-12 AWG  
Torque .....0.5-4 Nm / 4 lbs-in.  
Stripping Length ...8 mm

#### SCREW CLAMP

Part Number	Type	No. of Poles	Module Length (L) in mm(in.)	Std. Pk.
8937.2	DIPC14	14	45 (1.77)	1
8938.2	DIPC16	16	68 (2.68)	1
8939.2	DIPC20	20	68 (2.68)	1

#### SPRING CLAMP

Part Number	Type	No. of Poles	Module Length (L) in mm(in.)	Std. Pk.
8937.2/S	DIPC14	14	45 (1.77)	1
8938.2/S	DIPC16	16	56 (2.20)	1
8939.2/S	DIPC20	20	56 (2.20)	1

PTH holes for convenient  
component insertion and  
easy soldering.

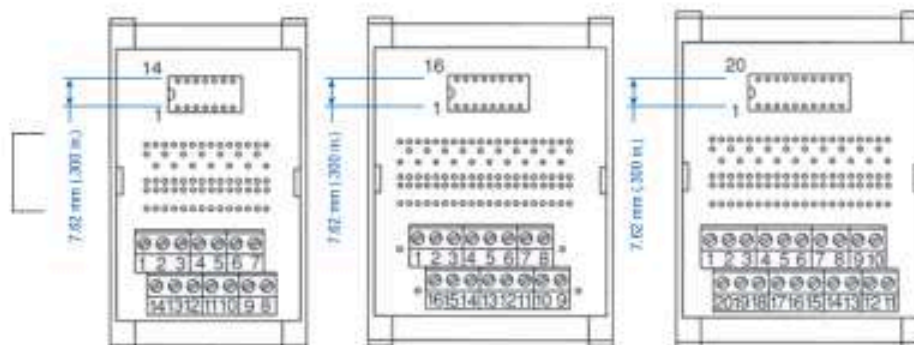

<sup>1</sup> Current Ratings  
Printed Circuit Traces: 3.5A  
Terminal Blocks: 15A  
Dip Socket: 3A

### RJ45 INTERFACES CONNECTOR-TO-WIRE 35 or 32mm DIN Rail Mount

TS35x7.5 56mm (2.20 in.)  
TS32x15 61mm (2.40 in.)

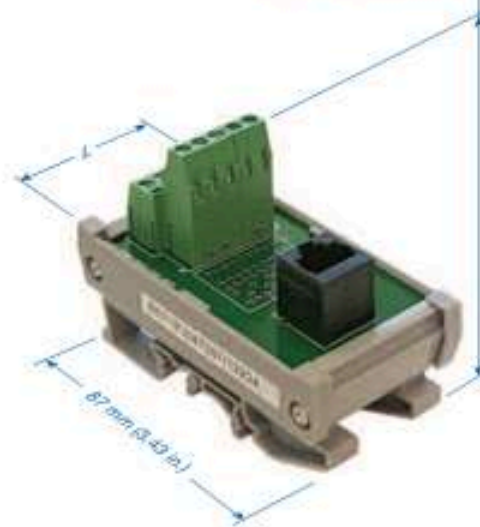

#### Technical Information

Current .....1.5 A  
Voltage .....150V AC  
Wire Range .....0.5-4 mm<sup>2</sup> / 20-12 AWG  
Torque .....0.5-4 Nm / 4 lbs-in.  
Stripping Length ...8 mm

#### SCREW CLAMP - VERTICAL - Top Entry

Part Number	Type	No. of Poles	Module Length (L) in mm(in.)	Std. Pk.
5718.2	RJ45	8	36 (1.42)	1
5719.2	RJ45 Shielded	8 + 2 shield	36 (1.42)	1

#### SCREW CLAMP - HORIZONTAL - Side Entry

5718.3	RJ45	8	36 (1.42)	1
5719.3	RJ45 Shielded	8 + 2 shield	36 (1.42)	1

#### SPRING CLAMP - VERTICAL - Top Entry

Part Number	Type	No. of Poles	Module Length (L) in mm(in.)	Std. Pk.
5718.2/S	RJ45	8	36 (1.42)	1
5719.2/S	RJ45 Shielded	8 + 2 shield	36 (1.42)	1

#### SPRING CLAMP - HORIZONTAL - Side Entry

5718.3/S	RJ45	8	36 (1.42)	1
5719.3/S	RJ45 Shielded	8 + 2 shield	36 (1.42)	1

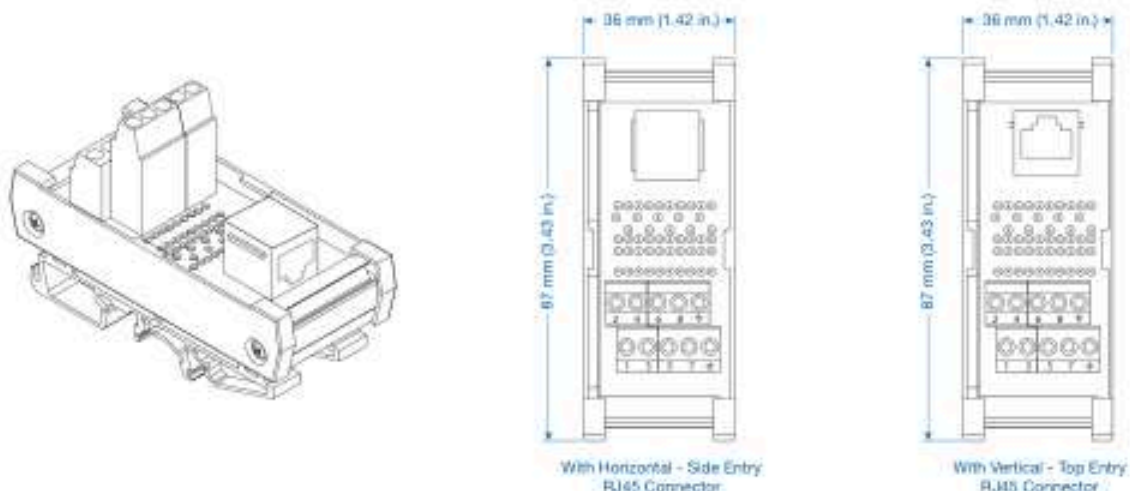

# Interfaces, Relay Modules and Carriers

## Isolated SPDT, 35 or 32 DIN Rail



### RC1 / RM1 SPDT (Single Pole Double Throw)

Isolated channels (no bus) allow control of each relay by a different logic system, if necessary. Mix sourcing (positive switching, Vcc on/off) and sinking (negative switching, ground on/off) on a single multi-relay module. Provide spare relay channels for future needs without committing to a specific logic power supply, and without committing coil-drive power for more than one relay at a time.

Altech Relay Modules provide high density packaging of miniature general purpose relays with Single Pole Double Throw (Form C) and Double Pole Double Throw (2 Form C) contact configurations and low current AC and DC coils. Load your own relays in our RC Relay Carrier, or order the RM Relay Module complete with relays.

Call us with your custom module requirements!

- Screw-Cage Clamp Connections
- Spring Clamp Terminals
- LED Coil Voltage Indicator
- Reverse DC Polarity LED Protection
- Surge Suppression with DC Coil
- DIN Rail Mount, Panel Mount Available

#### Technical Information

Current.....	12 A
Voltage (max) .....	250V AC / 24V DC
Wire Range .....	0.5-4 mm <sup>2</sup> / 30-14 AWG
Torque .....	0.5-4 Nm / 4 lbs-in.
Stripping Length...	8 mm

### SPDT

Number of Channels	Coil Voltage	Screw terminal		Spring terminal		Module Length (L) in mm (in)
		Carrier Only Part Number	Module with Relays Part Number	Carrier Only Part Number	Module with Relays Part Number	
1 Channel	12V DC	8929.5	8929.2	8929.5/S	8929.2/S	21 (0.83)
	24V DC	8933.5	8933.2	8933.5/S	8933.2/S	21 (0.83)
	110V AC	8935.5	8935.2	8935.5/S	8935.2/S	21 (0.83)
	220V AC	8940.5	8940.2	8940.5/S	8940.2/S	21 (0.83)
2 Channel	12V DC	8929.6	8929.3	8929.6/S	8929.3/S	40 (1.57)
	24V DC	8933.6	8933.3	8933.6/S	8933.3/S	40 (1.57)
	110V AC	8935.6	8935.3	8935.6/S	8935.3/S	40 (1.57)
	220V AC	8940.6	8940.3	8940.6/S	8940.3/S	40 (1.57)
4 Channel	12V DC	8931.5	8931.2	8931.5/S	8931.2/S	79 (3.11)
	24V DC	8941.5	8941.2	8941.5/S	8941.2/S	79 (3.11)
	110V AC	8942.5	8942.2	8942.5/S	8942.2/S	79 (3.11)
	220V AC	8943.5	8943.2	8943.5/S	8943.2/S	79 (3.11)
8 Channel	12V DC	8931.6	8931.3	8931.6/S	8931.3/S	157 (6.18)
	24V DC	8941.6	8941.3	8941.6/S	8941.3/S	157 (6.18)
	110V AC	8942.6	8942.3	8942.6/S	8942.3/S	157 (6.18)
	220V AC	8943.6	8943.3	8943.6/S	8943.3/S	157 (6.18)
16 Channel	12V DC	8932.5	8932.2	8932.5/S	8932.2/S	311 (12.24)
	24V DC	8944.5	8944.2	8944.5/S	8944.2/S	311 (12.24)
	110V AC	8946.5	8946.2	8946.5/S	8946.2/S	311 (12.24)
	220V AC	8948.5	8948.2	8948.5/S	8948.2/S	311 (12.24)

### CONTACT SPECIFICATIONS\*

SPDT Composite Rating .....	12A
Relay Socket .....	12A
Terminal Block .....	15A
PCB Trace for Contact Circuit at 30°C (86°F) temperature rise NC .....	12A
Common and NO .....	16A
PCB Trace for Coil Circuit at 30°C (86°F) temperature rise .....	6A
Relay Contact Material .....	AgNi
Rated load (capacity) .....	12A at 250VAC / 24VDC
Min. switching voltage .....	5 V
Min. switching current .....	5mA
Min. breaking capacity .....	0.3W

### RELAY PINOUT\*

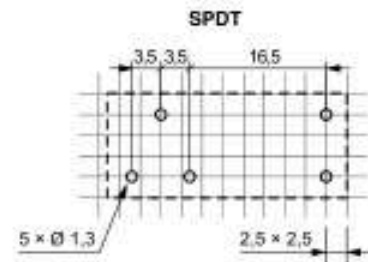

### COIL SPECIFICATIONS\*

Ambient Temperature..... -40°C/+85°C (-40°F/+185°F)

Coil Voltage AC / DC	Coil operating range V AC / DC		Coil Current in mA	Coil resistance at 20°C in Ω	Acceptable resistance
	Min.	Max.			
12 VDC	8.4	30.6	40	360	± 10 %
24 VDC	16.8	61.2	20	1440	± 10 %
110 VAC	88	132	4.4	8900	± 10 %
220 VAC	176	264	2.2	35500	± 10 %

### CONTACT CIRCUITS\*

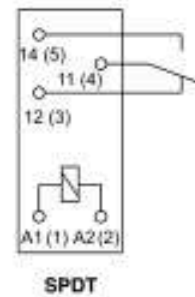

### COIL CIRCUITS

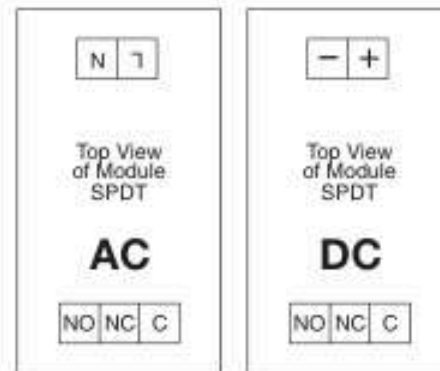
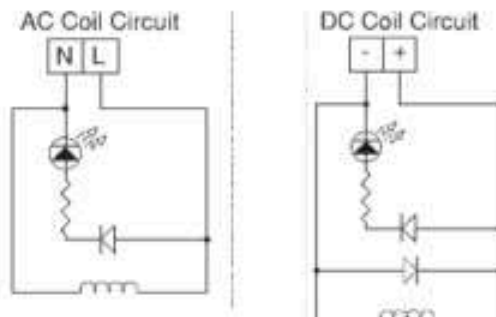

SPDT

\* For more information please see page 76 (Relay RM87)

# Interfaces, Relay Modules and Carriers

## Isolated DPDT, 35 or 32 DIN Rail



### RC2 / RM2 (Double Pole Double Throw)

Isolated channels (no bus) allow control of each relay by a different logic system, if necessary. Mix sourcing (positive switching, Vcc on/off) and sinking (negative switching, ground on/off) on a single multi-relay module. Provide spare relay channels for future needs without committing to a specific logic power supply, and without committing coil-drive power for more than one relay at a time.

Altech Relay Modules provide high density packaging of miniature general purpose relays with Single Pole Double Throw (Form C) and Double Pole Double Throw (2 Form C) contact configurations and low current AC and DC coils. Load your own relays in our RC Relay Carrier, or order the RM Relay Module complete with relays.

Call us with your custom module requirements!

- Screw-Cage Clamp Connections
- Spring Clamp Terminals
- LED Coil Voltage Indicator
- Reverse DC Polarity LED Protection
- Surge Suppression with DC Coil
- DIN Rail Mount, Panel Mount Available

#### Technical Information

Current.....	8 A
Voltage (max) .....	250V AC / 24V DC
Wire Range .....	0.5-4 mm <sup>2</sup> / 30-14 AWG
Torque .....	0.5-4 Nm / 4 lbs-in.
Stripping Length...	8 mm

### DPDT

Number of Channels	Coil Voltage	Screw terminal		Spring terminal		Module Length (L) in mm (in)
		Carrier Only Part Number	Module with Relays Part Number	Carrier Only Part Number	Module with Relays Part Number	
1 Channel	12V DC	8945.5	8945.2	8945.5/S	8945.2/S	21 (0.83)
	24V DC	8951.5	8951.2	8951.5/S	8951.2/S	21 (0.83)
	110V AC	8953.5	8953.2	8953.5/S	8953.2/S	21 (0.83)
	220V AC	8954.5	8954.2	8954.5/S	8954.2/S	21 (0.83)
2 Channel	12V DC	8949.6	8949.3	8949.6/S	8949.3/S	40 (1.57)
	24V DC	8951.6	8951.3	8951.6/S	8951.3/S	40 (1.57)
	110V AC	8953.6	8953.3	8953.6/S	8953.3/S	40 (1.57)
	220V AC	8954.6	8954.3	8954.6/S	8954.3/S	40 (1.57)
4 Channel	12V DC	8955.5	8955.2	8955.5/S	8955.2/S	79 (3.11)
	24V DC	8956.5	8956.2	8956.5/S	8956.2/S	79 (3.11)
	110V AC	8957.5	8957.2	8957.5/S	8957.2/S	79 (3.11)
	220V AC	8959.5	8959.2	8959.5/S	8959.2/S	79 (3.11)
8 Channel	12V DC	8955.6	8955.3	8955.6/S	8955.3/S	157 (6.18)
	24V DC	8956.6	8956.3	8956.6/S	8956.3/S	157 (6.18)
	110V AC	8957.6	8957.3	8957.6/S	8957.3/S	157 (6.18)
	220V AC	8959.6	8959.3	8959.6/S	8959.3/S	157 (6.18)
16 Channel	12V DC	8963.5	8963.2	8963.5/S	8963.2/S	311 (12.24)
	24V DC	8972.5	8972.2	8972.5/S	8972.2/S	311 (12.24)
	110V AC	8995.5	8995.2	8995.5/S	8995.2/S	311 (12.24)
	220V AC	8999.5	8999.2	8999.5/S	8999.2/S	311 (12.24)

### CONTACT SPECIFICATIONS\*

DPDT Rating .....	8A
Relay Socket .....	8A
Terminal Block .....	15A
PCB Trace for Contact Circuit at 30°C (86°F) temperature rise NC .....	10A
PCB Trace for Coil Circuit at 30°C (86°F) temperature rise .....	2A
Relay Contact Material .....	AgNi
Rated load (capacity) .....	8A at 250VAC / 24VDC
Min. switching voltage .....	5 V
Min. switching current .....	5mA
Min. breaking capacity .....	0.3W

### RELAY PINOUT\*

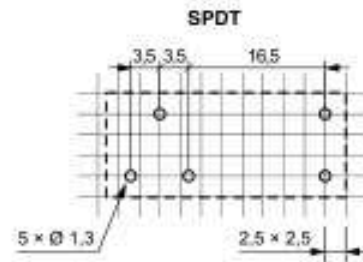

### COIL SPECIFICATIONS\*

Ambient Temperature..... -40°C+85°C (-40°F+185°F)

Coil Voltage AC / DC	Coil operating range V AC / DC		Coil Current in mA	Coil resistance at 20°C in Ω	Acceptable resistance
	Min.	Max.			
12 VDC	8.4	30.6	40	360	± 10 %
24 VDC	16.8	61.2	20	1440	± 10 %
110 VAC	88	132	4.4	8900	± 10 %
220 VAC	176	264	2.2	35500	± 10 %

### CONTACT CIRCUITS\*

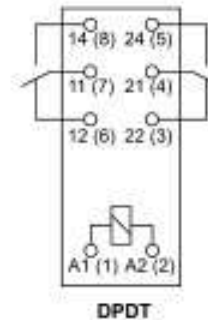

### COIL CIRCUITS

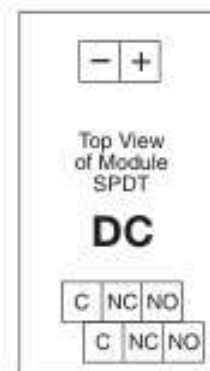
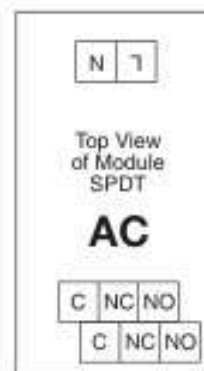
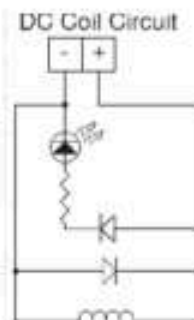
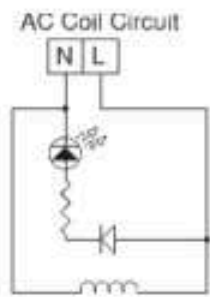

DPDT

\* For more information please see page 76 (Relay RM84)

# Interfaces, Relay Modules and Carriers

## Bussed SPDT, 35 or 32 DIN Rail



### RC1 / RM1 (Single Pole Double Throw)

Altech Bussed Relay Modules provide high density packaging of miniature general purpose relays with minimal hook-up wiring. Select from bussed DC Positive (DC Negative switching), bussed DC Negative (DC Positive switching), or bussed AC neutral.

Ideal for traditional mechanical relay input/output array between a single logic system and peripheral devices, or between logic systems in a network as well as their peripheral and field devices.

Load your own relays in our RCB Relay Carrier, or order the RMB Relay Module complete with 8 or 16 relays.

Call us with your custom module requirements!

- Screw-Cage Clamp Connections
- Spring Clamp Terminals
- LED Coil Voltage Indicator
- Reverse DC Polarity LED Protection
- Surge Suppression With DC Coil
- DIN Rail Mount, Panel Mount Available

#### Technical Information

Current.....	12 A
Voltage (max) .....	250V AC / 24V DC
Wire Range .....	0.5-4 mm <sup>2</sup> / 30-14 AWG
Torque .....	0.5-4 Nm / 4 lbs-in.
Stripping Length...	8 mm

### SPDT

Number of Channels	Coil Voltage	Screw terminal		Spring terminal		Module Length (L) in mm (in)
		Carrier Only Part Number	Module with Relays Part Number	Carrier Only Part Number	Module with Relays Part Number	
8 Channel, Bussed DC+	12V DC (E)	8912.5	8912.2	8912.5/S	8912.2/S	125 (4.92)
	24V DC (G)	5494.5	5494.2	5494.5/S	5494.2/S	125 (4.92)
8 Channel, Bussed DC-	12V DC (E)	8912.6	8912.3	8912.6/S	8912.3/S	125 (4.92)
	24V DC (G)	5492.5	5492.2	5492.5/S	5492.2/S	125 (4.92)
8 Channel, Bussed AC (N)	110V AC (U)	5502.5	5502.2	5502.5/S	5502.2/S	125 (4.92)
	220V AC (X)	8913.6	8913.3	8913.6/S	8913.3/S	125 (4.92)
16 Channel, Bussed DC+	12V DC (E)	8914.5	8914.2	8914.5/S	8914.2/S	248 (9.76)
	24V DC (G)	5508.5	5508.2	5508.5/S	5508.2/S	248 (9.76)
16 Channel, Bussed DC-	12V DC (E)	8921.5	8921.2	8921.5/S	8921.2/S	248 (9.76)
	24V DC (G)	5506.5	5506.2	5506.5/S	5506.2/S	248 (9.76)
16 Channel, Bussed AC(N)	110V AC (U)	5514.5	5514.2	5514.5/S	5514.2/S	248 (9.76)
	220V AC (X)	5514.6	5514.3	5514.6/S	5514.3/S	248 (9.76)

### CONTACT SPECIFICATIONS\*

SPDT Composite Rating .....	12A
Relay Socket .....	12A
Terminal Block .....	15A
PCB Trace for Contact Circuit at 30°C (86°F) temperature rise NC .....	12A
PCB Trace for Coil Circuit at 30°C (86°F) temperature rise .....	4A
PCB Trace for Bus at 30°C (86°F) temperature rise .....	16A
Relay Contact Material .....	AgNi
Rated load (capacity) .....	12A at 250VAC / 24VDC
Min. switching voltage .....	5 V
Min. switching current .....	5mA
Min. breaking capacity .....	0.3W

### RELAY PINOUT\*

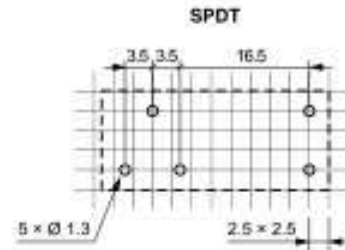

### COIL SPECIFICATIONS\*

Ambient Temperature..... -40°C/+85°C (-40°F/+185°F)

Coil Voltage AC / DC	Coil operating range V AC / DC		Coil Current in mA	Coil resistance at 20°C in Ω	Acceptable resistance
	Min.	Max.			
12 VDC	8.4	30.6	40	360	± 10 %
24 VDC	16.8	61.2	20	1440	± 10 %
110 VAC	88	132	4.4	8900	± 10 %
220 VAC	176	264	2.2	35500	± 10 %

### CONTACT CIRCUITS\*

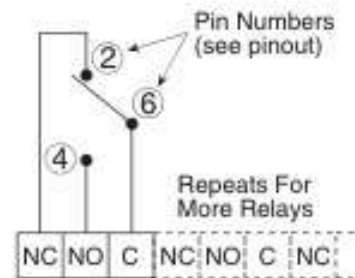

### COIL CIRCUITS

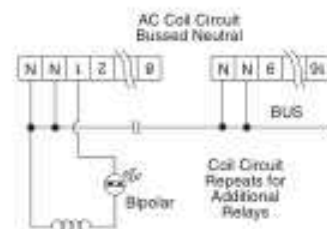
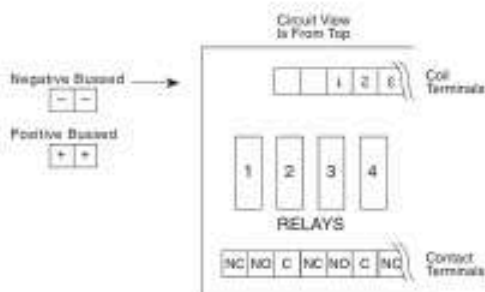
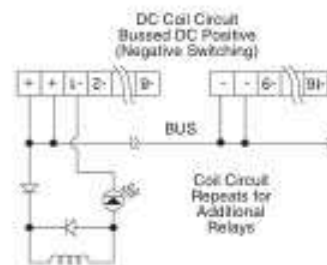
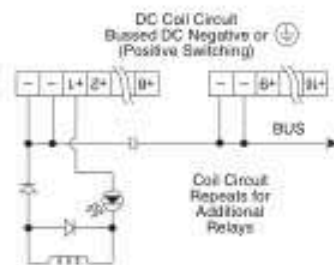

\* For more information please see page 76 (Relay RM87)

# Interfaces, Relay Modules and Carriers

## Bussed DPDT, 35 or 32 DIN Rail



### RC2 / RM2 (Double Pole Double Throw)

Altech Bussed Relay Modules provide high density packaging of miniature general purpose relays with minimal hook-up wiring. Select from bussed DC Positive (DC Negative switching), bussed DC Negative (DC Positive switching), or bussed AC neutral.

Ideal for traditional mechanical relay input/output array between a single logic system and peripheral devices, or between logic systems in a network as well as their peripheral and field devices.

Load your own relays in our RCB Relay Carrier, or order the RMB Relay Module complete with 8 or 16 relays.

Call us with your custom module requirements!

- Screw-Cage Clamp Connections
- Spring Clamp Terminals
- LED Coil Voltage Indicator
- Reverse DC Polarity LED Protection
- Surge Suppression With DC Coil
- DIN Rail Mount, Panel Mount Available

#### Technical Information

Current.....	8 A
Voltage (max) .....	250V AC / 24V DC
Wire Range .....	0.5-4 mm <sup>2</sup> / 30-14 AWG
Torque .....	0.5-4 Nm / 4 lbs-in.
Stripping Length...	8 mm

### DPDT

Number of Channels	Coil Voltage	Screw terminal		Spring terminal		Module Length (L) in mm (in)
		Carrier Only Part Number	Module with Relays Part Number	Carrier Only Part Number	Module with Relays Part Number	
8 Channel, Bussed DC+	12V DC (E)	8923.5	8923.2	8923.5/S	8923.2/S	125 (4.92)
	24V DC (G)	8924.5	8924.2	8924.5/S	8924.2/S	125 (4.92)
8 Channel, Bussed DC-	12V DC (E)	8923.6	8923.3	8923.6/S	8923.3/S	125 (4.92)
	24V DC (G)	8924.6	8924.4	8924.6/S	8924.4/S	125 (4.92)
8 Channel, Bussed AC (N)	110V AC (U)	8925.5	8925.2	8925.5/S	8925.2/S	125 (4.92)
	220V AC (X)	8925.6	8925.3	8925.6/S	8925.3/S	125 (4.92)
16 Channel, Bussed DC+	12V DC (E)	8926.5	8926.2	8926.5/S	8926.2/S	248 (9.76)
	24V DC (G)	8926.6	8926.3	8926.6/S	8926.3/S	248 (9.76)
16 Channel, Bussed DC-	12V DC (E)	8927.5	8927.2	8927.5/S	8927.2/S	248 (9.76)
	24V DC (G)	8927.6	8927.3	8927.6/S	8927.3/S	248 (9.76)
16 Channel, Bussed AC(N)	110V AC (U)	8928.5	8928.2	8928.5/S	8928.2/S	248 (9.76)
	220V AC (X)	8928.6	8928.3	8928.6/S	8928.3/S	248 (9.76)

### CONTACT SPECIFICATIONS\*

DPDT Rating .....	8A
Relay Socket.....	8A
Terminal Block.....	15A
PCB Trace for Contact Circuit	
at 30°C (86°F) temperature rise NC.....	8A
PCB Trace for Coil Circuit	
at 30°C (86°F) temperature rise .....	2A
PCB Trace for Bus	
at 30°C (86°F) temperature rise .....	16A
Relay Contact Material .....	AgNi
Rated load (capacity) .....	8A at 250VAC / 24VDC
Min. switching voltage .....	5 V
Min. switching current .....	5mA
Min. breaking capacity.....	0.3W

### RELAY PINOUT\*

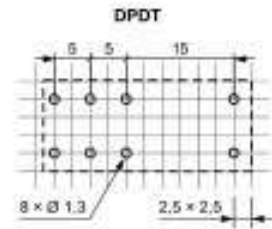

### COIL SPECIFICATIONS\*

Ambient Temperature..... -40°C/+85°C (-40°F/+185°F)

Coil Voltage AC / DC	Coil operating range V AC / DC		Coil Current in mA	Coil resistance at 20°C in Ω	Acceptable resistance
	Min.	Max.			
12 VDC	8.4	30.6	40	360	± 10 %
24 VDC	16.8	61.2	20	1440	± 10 %
110 VAC	88	132	4.4	8900	± 10 %
220 VAC	176	264	2.2	35500	± 10 %

### CONTACT CIRCUITS\*

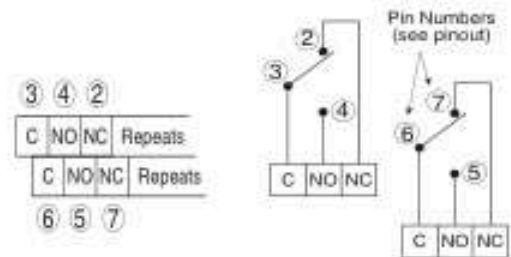

### COIL CIRCUITS

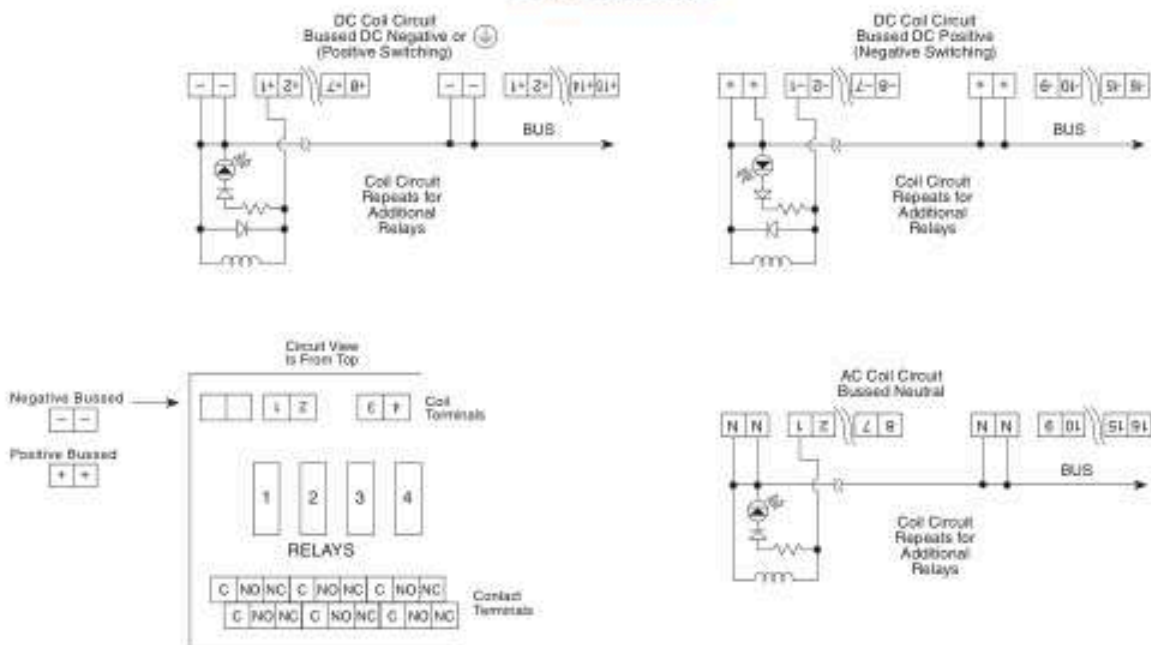

\* For more information please see page 76 (Relay RM84)

# Interfaces, High Current Isolated

## Isolated Channels - 16 Amp, 35 or 32 DIN Rail

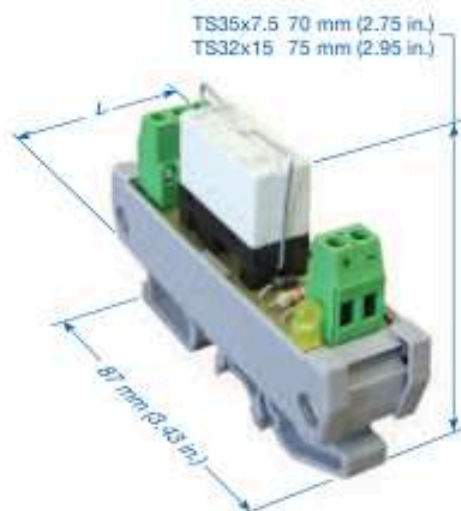

### RMH1 - 1 Channel (Single Pole Double Throw)

A true high-current rating in a DIN Rail mount miniature relay module. The miniature relays used in the Altech RMH have a SPDT (Form C) 16 Amp continuous current rating, developed from dual 8 Amp contacts that are internally connected in parallel. The relay socket is rated dual 8 Amp. Printed circuit traces are balanced, rated 16 Amp and connect to Altech terminal blocks UL rated 15A/300V.

Typical relay specifications combined with other module component ratings give module ratings suitable for many control applications.

- Screw-Cage Clamp Connection
- Spring Clamp Terminals
- LED Coil Voltage Indicator
- Reverse DC Polarity LED Protection
- Surge Suppression With DC Coils
- Industry Standard Relays\*
- DIN Rail Mount, Panel Mount Available

#### Technical Information

Current.....16 A  
 Voltage (max) .....250V AC / 24V DC  
 Wire Range .....0.5-4 mm<sup>2</sup> / 30-14 AWG  
 Torque .....0.5-4 Nm / 4 lbs-in.  
 Stripping Length...8 mm

SPDT DC	Coil Voltage	Screw terminal Part Number	Spring terminal Part Number	LED (2mA)	Module Length (L) in mm (in)
1 Channel	5V DC	8905.2	8905.2/S	Yellow	21 (0.83)
1 Channel	6V DC	8906.2	8906.2/S	Green	21 (0.83)
1 Channel	12V DC	8907.2	8907.2/S	Red	21 (0.83)
1 Channel	24V DC	5800.2	5800.2/S	Yellow	21 (0.83)
1 Channel	48V DC	5802.2	5802.2/S	Green	21 (0.83)
1 Channel	60V DC	8908.2	8908.2/S	Red	21 (0.83)
1 Channel	110V DC	5803.2	5803.2/S	Red	21 (0.83)

SPDT AC	Coil Voltage	Screw terminal Part Number	Spring terminal Part Number	LED (2mA)	Module Length (L) in mm (in)
1 Channel	6V AC	8909.2	8909.2/S	Green	21 (0.83)
1 Channel	12V AC	8910.2	8910.2/S	Red	21 (0.83)
1 Channel	24V AC	5801.2	5801.2/S	Red	21 (0.83)
1 Channel	50V AC	8911.2	8911.2/S	Red	21 (0.83)
1 Channel	110V AC	5804.2	5804.2/S	Yellow	21 (0.83)
1 Channel	220V AC	5805.2	5805.2/S	Green	21 (0.83)
1 Channel	240V AC	5806.2	5806.2/S	Red	21 (0.83)

## GENERAL RELAY SPECIFICATIONS\*

Mechanical Life (cycles) ..... >  $3 \times 10^7$   
 Max operating frequency  
 • at rated load ..... 600 cycles/hour  
 • no load ..... 72000 cycles/hour  
 Operating / release time ..... 7 ms/ 3 ms

## COIL SPECIFICATIONS\*

Contact material ..... AgNi  
 Rated load ( capacity) ..... 16A at 250V AC / 24 V DC  
 Max. breaking capacity ..... 4000 VA  
 Min. breaking capacity ..... 0.3 W  
 Electrical life ( resistive AC1) ..... >  $0.7 \times 10^7$

Coil Voltage AC / DC	Coil operating range V AC / DC		Coil Current in mA	Coil resistance at 20°C in Ω	Acceptable resistance
	Min.	Max.			
5.0	3.5	12.7	96.0	60.0	± 10 %
6.0	4.2	15.3	80.0	90.0	± 10 %
12.0	8.4	30.6	40.0	360.0	± 10 %
24.0	16.8	61.2	20.0	1,440.0	± 10 %
48.0	33.6	122.4	10.0	5,700.0	± 10 %
60.0	42.0	153.0	8.0	7,500.0	± 10 %
110.0	77.0	280.0	4.4	25,200.0	± 10 %

## RELAY PINOUT\*

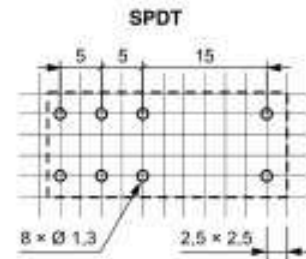

## CONTACT CIRCUITS\*

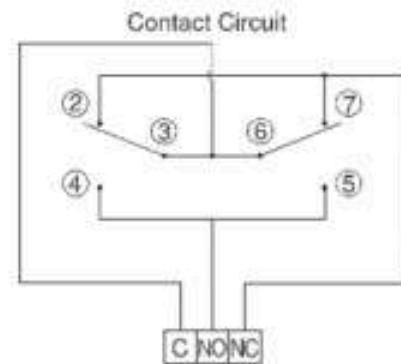

## COIL CIRCUITS

### AC COIL CIRCUIT

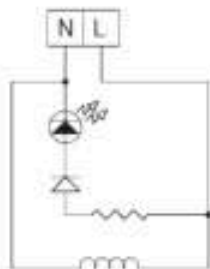

### DC COIL CIRCUIT

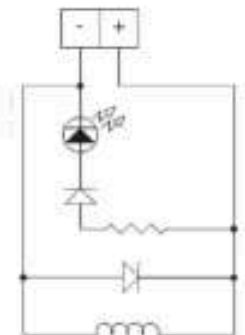

\* For more information please see page 76 (Relay RM85)

# Interfaces, High Current Isolated

## Isolated Channels - 16 Amp, 35 or 32 DIN Rail

### RMH4 - 4 Channel (Single Pole Double Throw)

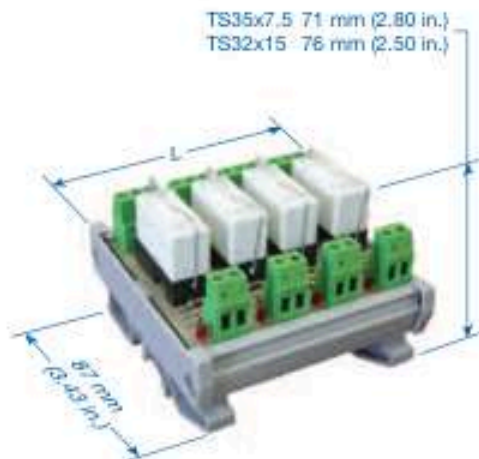

A true high-current rating in a DIN Rail mount miniature relay module. The miniature relays used in the Altech RMH have a SPDT (Form C) 16 Amp continuous current rating, developed from dual 8 Amp contacts that are internally connected in parallel. The relay socket is rated dual 8 Amp. Printed circuit traces are balanced, rated 16 Amp and connect to Altech terminal blocks UL rated 15A/300V.

Typical relay specifications combined with other module component ratings give module ratings suitable for many control applications.

- Screw-Cage Clamp Connection
- Spring Clamp Terminals
- LED Coil Voltage Indicator
- Reverse DC Polarity LED Protection
- Surge Suppression With DC Coils
- Industry Standard Relays\*
- DIN Rail Mount, Panel Mount Available

#### Technical Information

Current.....	16 A
Voltage (max) .....	250V AC / 24V DC
Wire Range .....	0.5-4 mm <sup>2</sup> / 30-14 AWG
Torque .....	0.5-4 Nm / 4 lbs-in.
Stripping Length...	8 mm

SPDT DC	Coil Voltage	Screw terminal Part Number	Spring terminal Part Number	LED (2mA)	Module Length (L) in mm (in)
4 Channel	5V DC	8905.3	8905.3/S	Yellow	79 (3.11)
4 Channel	6V DC	8906.3	8906.3/S	Green	79 (3.11)
4 Channel	12V DC	8907.3	8907.3/S	Red	79 (3.11)
4 Channel	24V DC	5800.3	5800.3/S	Yellow	79 (3.11)
4 Channel	48V DC	5802.3	5802.3/S	Green	79 (3.11)
4 Channel	60V DC	8908.3	8908.3/S	Red	79 (3.11)
4 Channel	110V DC	5803.3	5803.3/S	Red	79 (3.11)

SPDT AC	Coil Voltage	Screw terminal Part Number	Spring terminal Part Number	LED (2mA)	Module Length (L) in mm (in)
4 Channel	6V AC	8909.3	8909.3/S	Green	79 (3.11)
4 Channel	12V AC	8910.3	8910.3/S	Red	79 (3.11)
4 Channel	24V AC	5801.3	5801.3/S	Red	79 (3.11)
4 Channel	50V AC	8911.3	8911.3/S	Red	79 (3.11)
4 Channel	110V AC	5804.3	5804.3/S	Yellow	79 (3.11)
4 Channel	220V AC	5805.3	5805.3/S	Green	79 (3.11)
4 Channel	240V AC	5806.3	5806.3/S	Red	79 (3.11)

### GENERAL RELAY SPECIFICATIONS\*

Mechanical Life (cycles) ..... > 3 x 10<sup>7</sup>  
 Max operating frequency  
 • at rated load ..... 600 cycles/hour  
 • no load ..... 72000 cycles/hour  
 Operating / release time ..... 7 ms/ 3 ms

### COIL SPECIFICATIONS\*

Contact material ..... AgNi  
 Rated load ( capacity) ..... 16A at 250V AC / 24 V DC  
 Max. breaking capacity ..... 4000 VA  
 Min. breaking capacity ..... 0.3 W  
 Electrical life ( resistive AC1) ..... > 0.7 x 10<sup>7</sup>

Coil Voltage AC / DC	Coil operating range V AC / DC		Coil Current in mA	Coil resistance at 20°C in Ω	Acceptable resistance
	Min.	Max.			
5.0	3.5	12.7	96.0	60.0	± 10 %
6.0	4.2	15.3	80.0	90.0	± 10 %
12.0	8.4	30.6	40.0	360.0	± 10 %
24.0	16.8	61.2	20.0	1,440.0	± 10 %
48.0	33.6	122.4	10.0	5,700.0	± 10 %
60.0	42.0	153.0	8.0	7,500.0	± 10 %
110.0	77.0	280.0	4.4	25,200.0	± 10 %

### RELAY PINOUT\*

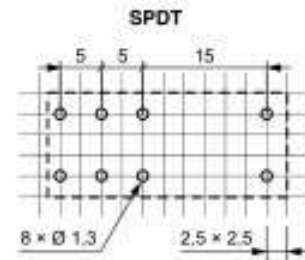

### CONTACT CIRCUITS\*

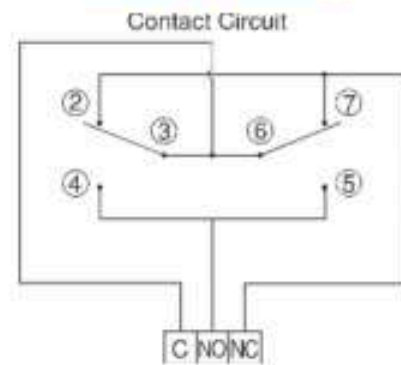

### COIL CIRCUITS

#### AC COIL CIRCUIT

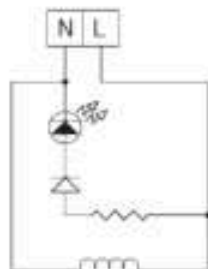

#### DC COIL CIRCUIT

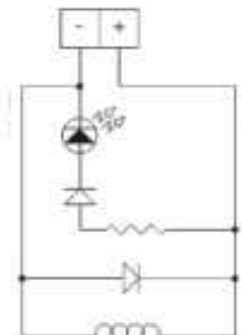

\* For more information please see page 76 (Relay RM85)

# Safety Relay Modules

## Isolated Channels - 8 Amp Contacts, 35 or 32 DIN Rail

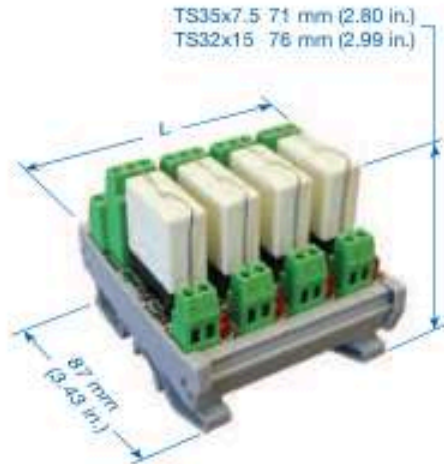

### Isolated Channel (Double Pole Double Throw)

Altech Safety Relay Modules utilize Relays with Force-Guided-Contacts that meet or exceed international standards, TÜV and UL. They are designed to protect man and machine as specified in OSHA FR1910 Regulations, a mandatory requirement of the European Machinery Directive EMD 89.392 EEC. The Safety Relays are used in Safety Devices such as Emergency Stop Modules, Safety Gate Monitors, 2-Hand Safety Modules, etc.

This series of Safety Relay Modules are Double Pole, Double Throw configurations, and are available as 1, 2, 4, 8 and 16 isolated channels and 8 and 16 bussed channels with 12 or 24 VDC coils. Isolated channels allow control of each relay by a different logic system, if necessary. There are two inputs for each relay coil per channel. Bussed channels allow high density packaging with a common input for all relays. Safety Relay Modules may be ordered with three different types of relay contact material, depending on the actual load current.

- Screw-Cage Clamp Connection
- LED Coil Voltage Indicator
- Reverse DC Polarity LED Protection
- Surge Suppression With DC Coils
- Industry Standard Relays
- DIN Rail Mount, Panel Mount Available

### DPDT

Isolated Channel (no bus)	Coil Voltage	Contact Material: $\text{AgSnO}_2+0.2\mu\text{mAu}$	Contact Material: $\text{AgNi}10+0.2\mu\text{mAu}$	Contact Material: $\text{AgNi}10+5\mu\text{mAu}$	Module Length (L) in mm (in) <sup>o</sup>
		Contact Ratings: 8A(2x5A) 250VDC, 400VAC	Contact Ratings: 8A(2x5A) 250VDC, 400VAC	Contact Ratings: 8A(2x5A) 250VDC, 400VAC	
		Part Number	Part Number	Part Number	
1 Channel	12V	8949.2C	8949.2N	8949.2S	21 (0.83)
1 Channel	24V	8951.2C	8951.2N	8951.2S	21 (0.83)
2 Channel	12V	8949.3C	8949.3N	8949.3S	40 (1.57)
2 Channel	24V	8951.3C	8951.3N	8951.3S	40 (1.57)
4 Channel	12V	8955.2C	8955.2N	8955.2S	79 (3.11)
4 Channel	24V	8956.2C	8956.2N	8956.2S	79 (3.11)
8 Channel	12V	8955.3C	8955.3N	8955.3S	157 (6.18)
8 Channel	24V	8956.3C	8956.3N	8956.3S	157 (6.18)
16 Channel	12V	8963.2C	8963.2N	8963.2S	311 (12.24)
16 Channel	24V	8972.2C	8972.2N	8972.2S	311 (12.24)

# Safety Relay Modules

Isolated Channels - 8 Amp Contacts, 35 or 32 DIN Rail

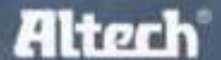

## Relay Pinout

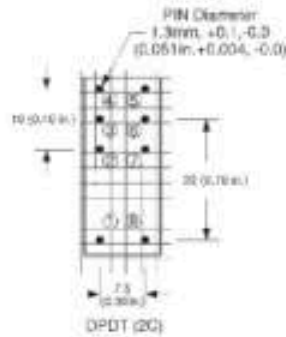

Bottom View, Relay Pinouts, Grid 2.54mm (0.1in.)

## Coil Circuits

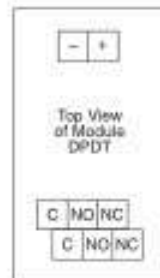
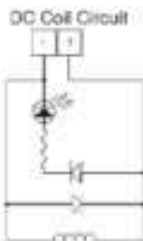

## Contact Circuits

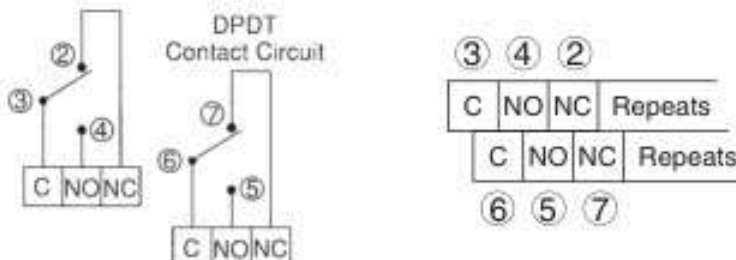

## Relay Specifications

-Normal Coil Voltage: 12,24 VDC  
 -Coil Power Dissipation: 0.7W  
 -Max. Switching Voltage: 250 VDC, 400 AC  
 -Max. Switching Current: 8A(2x5A simultaneous)

-Max. Switching Power  
 DC 200W (2x160W simultaneous)  
 AC 2000VA (2x1250VA simultaneous)

-Contact Switching Rate: 10 operations/ sec.  
 -Relay Operate Time: ≤15 ms  
 -Relay Release Time: ≤12 ms  
 -Contact Arrangements: DPDT, 2 FORM C

-Contact Material:  
 Standard: AgNi10+0.2μmAu  
 Optional: AgSnO<sub>2</sub>+0.2μmAu  
 AgNi10+5μmAu

-Mechanical Life: ≥50x10<sup>6</sup> operation cycles  
 -Ambient Temperature: -40°+ 70°C  
 -Cover Material: Polyamide 6  
 -Weight: 15g

## Coil Specifications

Rated Voltage	Voltage Range	Coil Resistance
12VDC	9.6V-19.2V	210Ω ± 10%
24VDC	19.2V-38.4V	820Ω ± 10%

# Safety Relay Modules

## Bused Channels - 8 Amp Contacts, 35 or 32 DIN Rail

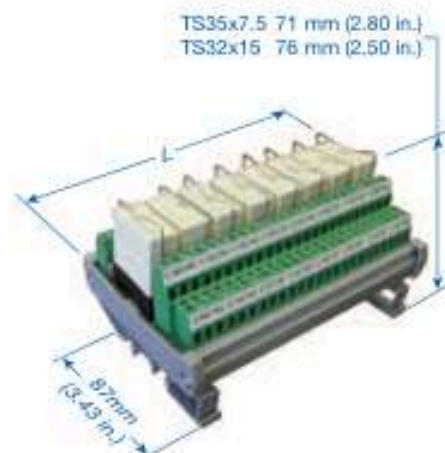

### Bused Channel (Double Pole Double Throw)

Altech Safety Relay Modules utilize Relays with Force-Guided-Contacts that meet or exceed international standards, TÜV and UL. They are designed to protect man and machine as specified in OSHA FR1910 Regulations, a mandatory requirement of the European Machinery Directive EMD 89.392 EEC. The Safety Relays are used in Safety Devices such as Emergency Stop Modules, Safety Gate Monitors, 2-Hand Safety Modules, etc.

This series of Safety Relay Modules are Double Pole, Double Throw configurations, and are available as 1, 2, 4, 8 and 16 isolated channels and 8 and 16 bused channels with 12 or 24 VDC coils. Isolated channels allow control of each relay by a different logic system, if necessary. There are two inputs for each relay coil per channel. Bused channels allow high density packaging with a common input for all relays. Safety Relay Modules may be ordered with three different types of relay contact material, depending on the actual load current.

- Screw-Cage Clamp Connection
- LED Coil Voltage Indicator
- Reverse DC Polarity LED Protection
- Surge Suppression With DC Coils
- Industry Standard Relays
- DIN Rail Mount, Panel Mount Available

### DPDT

Bused Channels	Coil Voltage	Contact Material: AgSnO <sub>2</sub> +0.2µmAu	Contact Material: AgNi10+0.2µmAu	Contact Material: AgNi10+5µmAu	Module Length (L) in mm (in) <sup>m</sup>
		Contact Ratings: 8A(2x5A) 250VDC, 400VAC	Contact Ratings: 8A(2x5A) 250VDC, 400VAC	Contact Ratings: 8A(2x5A) 250VDC, 400VAC	
		Part Number	Part Number	Part Number	
8 Channel, DC+	12V	8923.2C	8923.2N	8923.2S	125 (4.92)
8 Channel, DC+	24V	8924.2C	8924.2N	8924.2S	125 (4.92)
8 Channel, DC-	12V	8923.3C	8923.3N	8923.3S	125 (4.92)
8 Channel, DC-	24V	8924.4C	8924.4N	8924.4S	125 (4.92)
16 Channel, DC+	12V	8926.2C	8926.2N	8926.2S	248 (9.76)
16 Channel, DC+	24V	8926.3C	8926.3N	8926.3S	248 (9.76)
16 Channel, DC-	12V	8927.2C	8927.2N	8927.2S	248 (9.76)
16 Channel, DC-	24V	8927.3C	8927.3N	8927.3S	248 (9.76)

# Safety Relay Modules

Bused Channels - 8 Amp Contacts, 35 or 32 DIN Rail

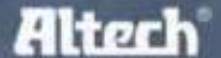

## Relay Pinout

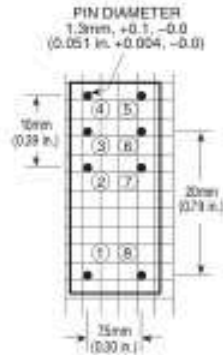

## Coil Circuits

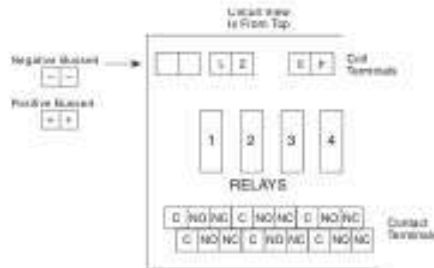
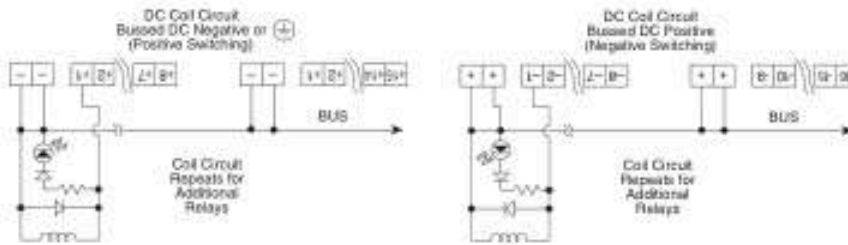

## Contact Circuits

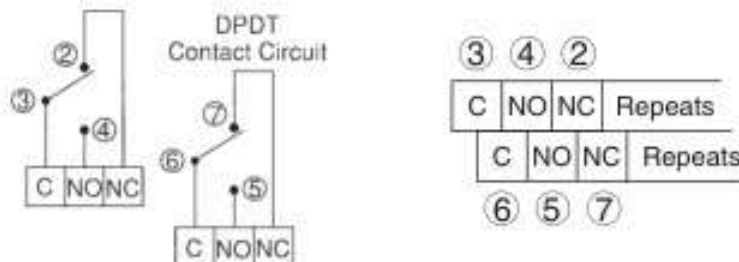

## Relay Specifications

- Normal Coil Voltage: 12,24 VDC
- Coil Power Dissipation: 0.7W
- Max. Switching Voltage: 250 VDC, 400 AC
- Max. Switching Current: 8A(2x5A simultaneous)
- Max. Switching Power:
  - DC 200W (2x160W simultaneous)
  - AC 2000VA (2x1250VA simultaneous)
- Contact Switching Rate: 10 operations/ sec.
- Relay Operate Time:  $\leq 15$  ms
- Relay Release Time:  $\leq 12$  ms
- Contact Arrangements: DPDT, 2 FORM C
- Contact Material:
  - Standard: AgNi10+0.2 $\mu$ mAu
  - Optional: AgSnO<sub>2</sub>+0.2 $\mu$ mAu, AgNi10+5 $\mu$ mAu
- Mechanical Life:  $\geq 50 \times 10^6$  operation cycles
- Ambient Temperature: -40°+ 70°C
- Cover Material: Polyamide 6
- Weight: 15g

## Coil Specifications

Rated Voltage	Voltage Range	Coil Resistance
12VDC	9.6V-19.2V	210 $\Omega$ $\pm$ 10%
24VDC	19.2V-38.4V	820 $\Omega$ $\pm$ 10%

# Safety Relay Modules

## 4 Pole Relays - 8 Amp, 35 or 32 DIN Rail

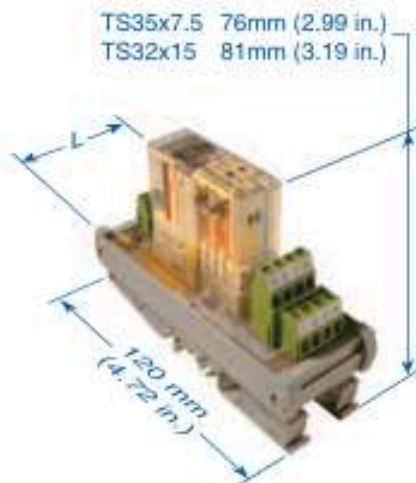

### 4 Pole, 8 Amp

Altech Safety Relay Modules utilize Relays with Force-Guided-Contacts that meet or exceed international standards, TÜV and UL. They are designed to protect man and machine as specified in OSHA CFR1910 Regulations, which is a mandatory requirement of the European Machinery Directive EMD 89.392 EEC.

- Screw-Cage clamp Connections
- LED Coil Voltage Indicator
- Reverse DC Polarity LED Protection
- Surge Suppression With DC Coil
- Din Rail Mount, Panel Mount Available

Altech Safety Relays are electro-mechanical relays that are mechanically linked together, causing all contacts to move together when the coil is energized. Force-Guided-contacts are also known as positive-guided-contacts, captive contacts or locked contacts. In addition, our Safety Relays have Crown Contacts which provide two locations per contacts to improve switching conditions. The Safety Relays are used in Safety Devices such as Emergency Stop Modules, Safety Gate Monitors, 2-Hand Safety Modules, Safety Light Curtains, etc.

This series of Safety Relay Modules consist of 4 pole relays with two choices of configurations (2NO/2NC or 3NO/1NC), with 8 or 10 Amp contacts, and are available as 1, 2, and 4 isolated channels with 12, or 24 VDC coils. Isolated channels allows control of each relay by a different logic system, if necessary. There are two inputs for each relay coil per channel. Safety Relay Modules may be ordered with three different types of relay contact material, depending on the actual load current. The part numbers shown in this data sheet are for our standard contact material, which is  $AgSnO_2 + 0.2\mu mAu$ .

		Contact Material*: $AgSnO_2 + 0.2\mu mAu$		
		Contact Ratings: 8A 250VDC, 400WAC		
		Contact Ratings:		
		2N.O + 2N.C	3N.O + 1N.C	
	Coil Voltage	Part Number	Part Number	Module Length (L) in mm (in)**
1 Channel	12V	156.OA11.1222C	156.OA11.1231C	40.10 (1.58)
1 Channel	24V	156.OA11.2422C	156.OA11.2431C	40.10 (1.58)
2 Channel	12V	256.OA11.1222C	256.OA11.1231C	78.20 (3.08)
2 Channel	24V	256.OA11.2422C	256.OA11.2431C	78.20 (3.08)
4 Channel	12V	456.OA11.1222C	456.OA11.1231C	154.40 (6.08)
4 Channel	24V	456.OA11.2422C	456.OA11.2431C	154.40 (6.08)

\* Note: Additional relay contact materials are available upon request. Please contact Altech for additional information.

# Safety Relay Modules

## 4 Pole Relays - 8 Amp, 35 or 32 DIN Rail

### 4 Pole, 8 Amp

#### DC Coil Circuits

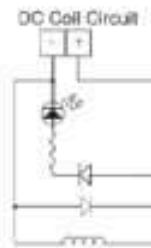

#### Contact Circuits

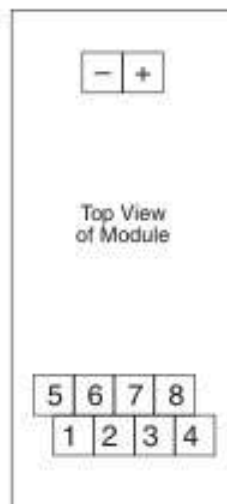

#### Relay Configurations

2 N.O + 2 N.C

NO Pin (1,2), (5,6)  
NC Pin (3,4), (7,8)

3 N.O + 1 N.C

NO Pin (1,2), (5,6), (7,8)  
NC Pin (3,4)

#### Relay Specifications - 8 Amps

-Normal Coil Voltage:	12,24 VDC
-Coil Power Dissipation:	0.6W
-Max. Switching Voltage:	250VDC, 400VAC
-Max. Switching Current:	8A
-Max. Switching Power:	
DC	200W
AC	2000VA
-Contact Switching Rate:	10 operations/ sec.
-Relay Operate Time:	20 ms
-Relay Release Time:	6 ms
-Contact Arrangements:	2NO/2NC, 3NO/1NC
-Contact Material:	
Standard:	AgSnO <sub>2</sub> +0.2µmAu
Optional:	AgNi10+0.2µmAu AgNi10+5µmAu
-Mechanical Life:	≥50x10 <sup>6</sup> operation cycles
-Ambient Temperature:	-40°+ 85°C
-Cover Material:	Thermoplast
-Weight:	35g

#### Coil Specifications

Rated Voltage	Voltage Range	Coil Resistance
12VDC	8.4V-16.8V	240Ω ± 10%
24VDC	16.8V-33.6V	960Ω ± 10%

# Safety Relay Modules

## 4 Pole Relays - 10 Amp, 35 or 32 DIN Rail

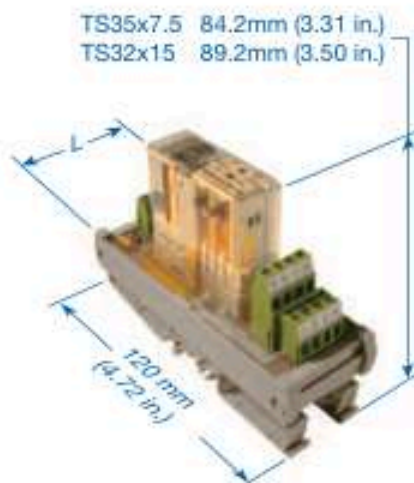

### 4 Pole, 10 Amp

Altech Safety Relay Modules utilize Relays with Force-Guided-Contacts that meet or exceed international standards, TÜV and UL. They are designed to protect man and machine as specified in OSHA CFR1910 Regulations, which is a mandatory requirement of the European Machinery Directive EMD 89.392 EEC.

- Screw-Cage clamp Connections
- LED Coil Voltage Indicator
- Reverse DC Polarity LED Protection
- Surge Suppression With DC Coil
- Din Rail Mount, Panel Mount Available

Altech Safety Relays are electro-mechanical relays that are mechanically linked together, causing all contacts to move together when the coil is energized. Force-Guided-contacts are also known as positive-guided-contacts, captive contacts or locked contacts. In addition, our Safety Relays have Crown Contacts which provide two locations per contacts to improve switching conditions. The Safety Relays are used in Safety Devices such as Emergency Stop Modules, Safety Gate Monitors, 2-Hand Safety Modules, Safety Light Curtains, etc.

This series of Safety Relay Modules consist of 4 pole relays with two choices of configurations (2NO/2NC or 3NO/1NC), with 8 or 10 Amp contacts, and are available as 1, 2, and 4 isolated channels with 12, or 24 VDC coils. Isolated channels allows control of each relay by a different logic system, if necessary. There are two inputs for each relay coil per channel. Safety Relay Modules may be ordered with three different types of relay contact material, depending on the actual load current. The part numbers shown in this data sheet are for our standard contact material, which is  $AgSnO_2 + 0.2\mu mAu$ .

	Coil Voltage	Contact Material*: $AgSnO_2 + 0.2\mu mAu$		Module Length (L) in mm (in)**
		2N.O + 2N.C	3N.O + 1N.C	
		Part Number	Part Number	
1 Channel	12V	156.0A01.1222C	156.0A01.1231C	40.10 (1.58)
1 Channel	24V	156.0A01.2422C	156.0A01.2431C	40.10 (1.58)
2 Channel	12V	256.0A01.1222C	256.0A01.1231C	78.20 (3.08)
2 Channel	24V	256.0A01.2422C	256.0A01.2431C	78.20 (3.08)
4 Channel	12V	456.0A01.1222C	456.0A01.1231C	154.40 (6.08)
4 Channel	24V	456.0A01.2422C	456.0A01.2431C	154.40 (6.08)

\* Note: Additional relay contact materials are available upon request. Please contact Altech for additional information.

# Safety Relay Modules

4 Pole Relays - 10 Amp, 35 or 32 DIN Rail

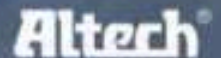

## 4 Pole, 10 Amp

### DC Coil Circuits

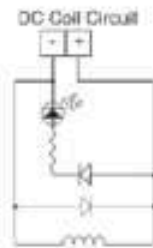

### Contact Circuits

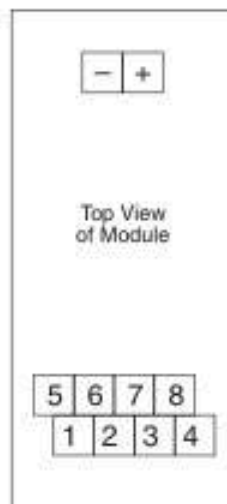

### Relay Configurations

2 N.O + 2 N.C

NO Pin (3,4), (7,8)  
NC Pin (1,2), (5,6)

3 N.O + 1 N.C

NO Pin (3,4), (5,6), (7,8)  
NC Pin (1,2)

### Relay Specifications - 10 Amps

-Normal Coil Voltage:	12,24 VDC
-Coil Power Dissipation:	0.75W
-Max. Switching Voltage:	250VDC, 400VAC
-Max. Switching Current:	10A
-Max. Switching Power	
DC	240W
AC	2500VA
-Contact Switching Rate:	10 operations/ sec.
-Relay Operate Time	27 ms
-Relay Release Time	5 ms
-Contact Arrangements	2NO/2NC, 3NO/1NC
-Contact Material:	
Standard:	AgSnO <sub>2</sub> +0.2μmAu
Optional:	AgNi10+0.2μmAu AgNi10+5μmAu
-Mechanical Life:	>30x10 <sup>6</sup> operation cycles
-Ambient Temperature:	-40°+ 80°C
-Cover Material:	Thermoplast
-Weight:	75g

### Coil Specifications

Rated Voltage	Voltage Range	Coil Resistance
12VDC	8.4V-19.2V	192Ω ± 10%
24VDC	16.8V-38.4V	770Ω ± 10%

# Safety Relay Modules

## 6 Pole Relays - 8 Amp, 35 or 32 DIN Rail

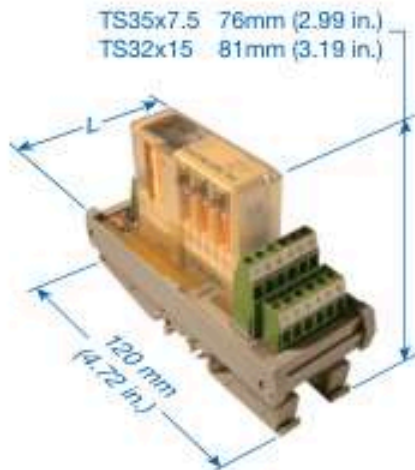

**Contact Ratings:**  
8A 250VDC, 400VAC

**Contact Configuration:**  
2NO + 4N  
3NO + 3NC  
4NO + 2NC  
5NO + 1NC

**Contact Material\*:**  
AgCdO+0.2µmAu

### 6 Pole, 8 Amp

Altech Safety Relay Modules utilize Relays with Force-Guided-Contacts that meet or exceed international standards, TÜV, CSA, CE, UKCA, and UL (relay only). They are designed to protect man and machine as specified in OSHA CFR1910 Regulations, which is a mandatory requirement of the European Machinery Directive EMD 89.392 EEC.

- Screw-Cage clamp Connections
- LED Coil Voltage Indicator
- Reverse DC Polarity LED Protection
- Surge Suppression With DC Coil
- Din Rail Mount, Panel Mount Available

Altech Safety Relays are electro-mechanical relays that are mechanically linked together, causing all contacts to move together when the coil is energized. Force-Guided-contacts are also known as positive-guided-contacts, captive contacts or locked contacts. In addition, our Safety Relays have Crown Contacts which provides two locations per contacts to improve switching conditions. The Safety Relays are used in Safety Devices such as Emergency Stop Modules, Safety Gate Monitors, 2-Hand Safety Modules, Safety Light Curtains, etc.

This series of Safety Relay Modules consist of 6 pole relays with three configuration choices (2NO+4NC, 3NO+3NC, 4NO+2NC, 5NO+1NC), 8 or 10 Amp contacts and either 1, 2 and 4 isolated channels with 12 or 24 VDC coils. Isolated channels allow control of each relay by a different logic system, if necessary. There are two inputs for each relay coil channel. Modules can be ordered with three contact materials, dependent upon the actual current load. The standard contact material is AgCdO+0.2µmAu.

		Part Number				Module Length (mm/in)
	Coil Voltage	2NO + 4NC	3NO + 3NC	4NO + 2NC	5NO + 1NC	
1 Channel	12V DC	156.0A12.1224C	156.0A12.1233C	156.0A12.1242C	156.0A12.1251C	46.5 (1.85)
1 Channel	24V DC	156.0A12.2424C	156.0A12.2433C	156.0A12.2442C	156.0A12.2451C	46.5 (1.85)
2 Channel	12V DC	256.0A12.1224C	256.0A12.1233C	256.0A12.1242C	256.0A12.1251C	91.0 (3.60)
2 Channel	24V DC	256.0A12.2424C	256.0A12.2433C	256.0A12.2442C	256.0A12.2451C	91.0 (3.60)
4 Channel	12V DC	456.0A12.1224C	456.0A12.1233C	456.0A12.1242C	456.0A12.1251C	180.0 (7.10)
4 Channel	24V DC	456.0A12.2424C	456.0A12.2433C	456.0A12.2442C	456.0A12.2451C	180.0 (7.10)

\* Note: Additional relay contact materials are available upon request. Please contact Altech for additional information.

# Safety Relay Modules

## 6 Pole Relays - 8 Amp, 35 or 32 DIN Rail

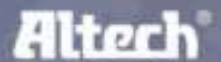

### 6 Pole, 8 Amp

#### DC Coil Circuits

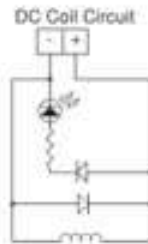

#### Contact Circuits

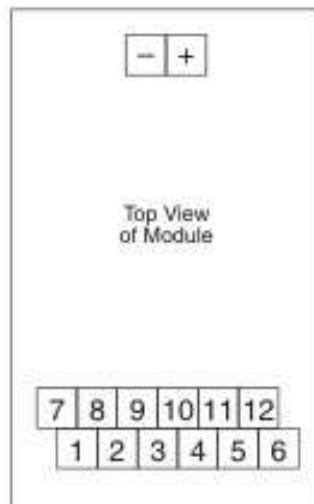

#### Relay Configurations

- 2NO + 4NC**  
 NO Pin (1,2), (7,8)  
 NC Pin (3,4), (5,6), (9,10), (11,12)
- 3NO + 3NC**  
 NO Pin (1,2), (7,8), (9,10)  
 NC Pin (3,4), (5,6), (11,12)
- 4NO + 2NC**  
 NO Pin (1,2), (3,4), (7,8), (9,10)  
 NC Pin (5,6), (11,12)
- 5NO + 1NC**  
 NO Pin (1,2), (3,4), (5,6), (7,8), (9,10)  
 NC Pin (11,12)

#### Relay Specifications - 8 Amps

-Normal Coil Voltage:	12,24 VDC
-Coil Power Dissipation:	0.8-1.0 W
-Max. Switching Voltage:	250VDC, 400VAC
-Max. Switching Current:	8A
-Max. Switching Power	
DC	200W
AC	2000VA
-Contact Switching Rate:	10 operations/ sec.
-Relay Operate Time	20 ms
-Relay Release Time	6 ms
-Contact Arrangements	2NO/4NC, 3NO/3NC, 4NO/2NC, 5NO/1NC
-Contact Material:	
Standard	AgSnO <sub>2</sub> +0.2µmAu
Optional	AgNi10+.0.2µmAu AgNi10+5µmAu
-Mechanical Life:	≥50x10 <sup>6</sup> operation cycles
-Ambient Temperature:	-40° + 85°C
-Cover Material:	Thermoplast
-Weight:	38g

#### Coil Specifications

Rated Voltage	Voltage Range	Coil Resistance
12VDC	8.4V-16.8V	145Ω ± 10%
24VDC	16.8V-33.6V	600Ω ± 10%

# Safety Relay Modules

## 6 Pole Relays - 10 Amp, 35 or 32 DIN Rail

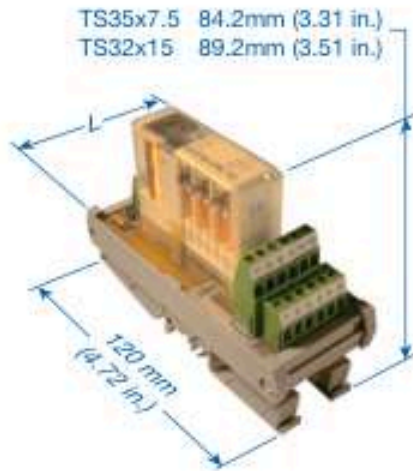

### 6 Pole, 10 Amp

Altech Safety Relay Modules utilize Relays with Force-Guided-Contacts that meet or exceed international standards, TÜV, SA, SUVA, and UL. They are designed to protect man and machine as specified in OSHA CFR1910 Regulations, which is a mandatory requirement of the European Machinery Directive EMD 89.392 EEC.

- Screw-Cage clamp Connections
- LED Coil Voltage Indicator
- Reverse DC Polarity LED Protection
- Surge Suppression With DC Coil
- Din Rail Mount, Panel Mount Available

Altech Safety Relays are electro-mechanical relays that are mechanically linked together, causing all contacts to move together when the coil is energized. Force-Guided-contacts are also known as positive-guided-contacts, captive contacts or locked contacts. In addition, our Safety Relays have Crown Contacts which provides two locations per contacts to improve switching conditions. The Safety Relays are used in Safety Devices such as Emergency Stop Modules, Safety Gate Monitors, 2-Hand Safety Modules, Safety Light Curtains, etc.

This series of Safety Relay Modules consist of 6 pole relays with three configuration choices (2NO+4NC, 3NO+3NC, 4NO+2NC), 8 or 10 Amp contacts and either 1, 2 and 4 isolated channels with 12 or 24 VDC coils. Isolated channels allow control of each relay by a different logic system, if necessary. There are two inputs for each relay coil channel. Modules can ordered with three contact materials, dependent upon the actual current load. The standard contact material is AgCd0+0.2µmAu.

	Coil Voltage	Contact Material*: AgCd0+0.2µmAu			Module Length (L) in mm (in)**
		2N.O + 4N.C	3N.O + 3N.C	4N.O + 2N.C	
		Part Number	Part Number	Part Number	
1 Channel	12V	156.0A02.1224C	156.0A02.1233C	156.0A02.1242C	46.45 (1.83)
1 Channel	24V	156.0A02.2424C	156.0A02.2433C	156.0A02.2442C	46.45 (1.83)
2 Channel	12V	256.0A02.1224C	256.0A02.1233C	256.0A02.1242C	90.90 (3.58)
2 Channel	24V	256.0A02.2424C	256.0A02.2433C	256.0A02.2442C	90.90 (3.58)
4 Channel	12V	456.0A02.1224C	456.0A02.1233C	456.0A02.1242C	179.80 (7.08)
4 Channel	24V	456.0A02.2424C	456.0A02.2433C	456.0A02.2442C	179.80 (7.08)

\* Note: Additional relay contact materials are available upon request. Please contact Altech for additional information.

# Safety Relay Modules

6 Pole Relays - 10 Amp, 35 or 32 DIN Rail

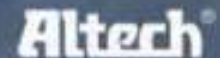

## 6 Pole, 10 Amp

### DC Coil Circuits

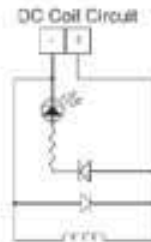

### Contact Circuits

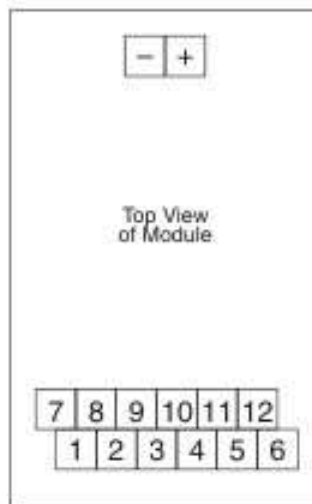

#### Relay Configurations

2N.O + 4N.C

NO Pin (5,6), (11,12)  
NC Pin (1,2), (3,4), (7,8), (9,10)

3N.O + 3N.C

NO Pin (3,4), (5,6), (11,12)  
NC Pin (1,2), (7,8), (9,10)

4N.O + 2N.C

NO Pin (3,4), (5,6), (9,10), (11,12)  
NC Pin (1,2), (7,8)

### Relay Specifications - 10 Amps

-Normal Coil Voltage:	12,24 VDC
-Coil Power Dissipation:	1.0 W
-Max. Switching Voltage:	250VDC, 400VAC
-Max. Switching Current:	10A
-Max. Switching Power	
DC	240W
AC	2500VA
-Contact Switching Rate:	10 operations/ sec.
-Relay Operate Time	27 ms
-Relay Release Time	5 ms
-Contact Arrangements	2NO/4NC, 3NO/3NC, 4NO/2NC
-Contact Material:	
Standard	AgSnO <sub>2</sub> +0.2μmAu
Optional	AgNi10+0.2μmAu AgNi10+5μmAu
-Mechanical Life:	≥30x10 <sup>4</sup> operation cycles
-Ambient Temperature:	-40°+ 80°C
-Cover Material:	Thermoplast
-Weight:	85g

### Coil Specifications

Rated Voltage	Voltage Range	Coil Resistance
12VDC	8.4V-19.2V	140Ω ± 10%
24VDC	16.8V-38.4V	570Ω ± 10%

# Safety Relay Modules

## 8 Pole - 10 Amp, 35 or 32 DIN Rail

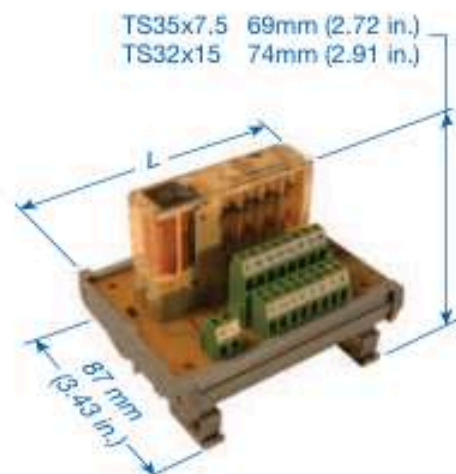

### 8 Pole, 10 Amp

These Safety Relay Modules utilize Relays with Force-Guided-Contacts that meet or exceed international standards, TÜV, SA, SUVA, and UL. They meet the standard EN50205 for safety relays, UL/94/VO fire protection, VDE 0106 Protection Class 11, and VDE 0110/group C 250VAC insulation class.

- Screw-Cage clamp Connections
- LED Coil Voltage Indicator
- Reverse DC Polarity LED Protection
- Surge Suppression With DC Coil
- Din Rail Mount, Panel Mount Available

Altech Safety Relays are electro-mechanical relays that are mechanically linked together, causing all contacts to move together when the coil is energized. Force-Guided-contacts are also known as positive-guided-contacts, captive contacts or locked contacts. In addition, our Safety Relays have Crown Contacts which provides two locations per contacts to improve switching conditions. The Safety Relays are used in Safety Devices such as Emergency Stop Modules, Safety Gate Monitors, 2-Hand Safety Modules, Safety Light Curtains, etc.

This series of Safety Relay Modules consists of 8 pole relays with 10 Amps in six configurations choices. Standard contact material for this series is AgSnO<sub>2</sub> + 0.2µmAu.

		Contact Material <sup>1</sup> : AgCdO+0.2µmAu				
		Contact Ratings: 10A 250VDC, 400VAC				
		7 NO/1 NC	Contacts: 6 NO/2 NC	5 NO/3 NC	Module Length (L) in mm (in)''	
	Coil Voltage	Part Number	Part Number	Part Number		
1 Channel	12	156.OA03.1271C	156.OA03.1262C	156.OA03.1253C	103.6 (4.08)	
1 Channel	24	156.OA03.2471C	156.OA03.2462C	156.OA03.2453C	103.6 (4.08)	
		4 NO/4 NC	Contacts: 3 NO/5 NC	2 NO/6 NC	Module Length (L) in mm (in)''	
	Coil Voltage	Part Number	Part Number	Part Number		
1 Channel	12	156.OA03.1244C	156.OA03.1235C	156.OA03.1226C	103.6 (4.08)	
1 Channel	24	156.OA03.2444C	156.OA03.2435C	156.OA03.2426C	103.6 (4.08)	

# Safety Relay Modules

## 8 Pole - 10 Amp, 35 or 32 DIN Rail

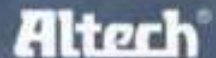

### 8 Pole, 10 Amp

#### DC Coil Circuits



#### Contact Circuits

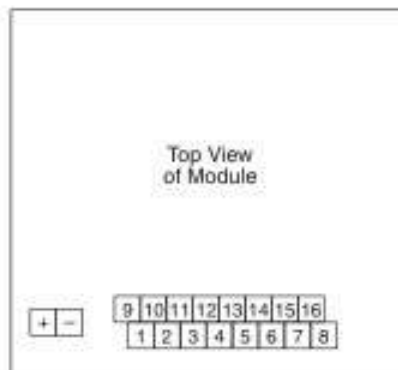

#### Relay Configurations

##### 2NO/6NC

NO Pin (7,8), (15,16)  
NC Pin (1,2), (3,4), (5,6), (9,10), (11,12), (13,14)

##### 3NO/5NC

NO Pin (5,6), (7,8), (15,16)  
NC Pin (1,2), (3,4), (9,10), (11,12), (13,14)

##### 4NO/4NC

NO Pin (5,6), (7,8), (13,14), (15,16)  
NC Pin (1,2), (3,4), (9,10), (11,12), (13,14)

##### 5NO/3NC

NO Pin (3,4), (5,6), (7,8), (13,14), (15,16)  
NC Pin (1,2), (9,10), (11,12)

##### 6NO/2NC

NO Pin (3,4), (5,6), (7,8), (11,12), (13,14), (15,16)  
NC Pin (1,2), (9,10)

##### 7NO/1NC

NO Pin (1,2), (3,4), (5,6), (7,8), (9,10), (11,12), (13,14), (15,16)  
NC Pin (9,10)

#### Relay Specifications - 8 Pole

-Normal Coil Voltage:	12, 24 VDC
-Coil Power Dissipation:	1.25-1.65W
-Max. Switching Voltage:	250VDC
-Max. Switching Current:	10A
-Max. Switching Power:	2500WAC
-Contact Switching Rate:	10 operations per second
-Relay Operate Time	27 ms
-Relay Release Time	5 ms
-Contact Arrangements:	2NO/16NC 3NO/5NC 4NO/4NC 5NO/3NC 6NO/2NC 7NO/1NC
-Contact Material:	AgSnO <sub>2</sub> +0.2µmAu
-Mechanical Life:	30x10 <sup>6</sup> operation cycles
-Ambient Temperature:	-25° + 75°C
-Weight:	85g

#### Coil Specifications

Rated Voltage	Min. Pick-up	Coil Resistance
12VDC	8.4V-15.2V	88Ω/112Ω ± 15%*
24VDC	16.8V-38.4V	370Ω/460Ω ± 15%*

\* 88Ω/370Ω for contact arrangements  
2NO/6NC, 3NO/5NC

\* 112Ω/460Ω for contact arrangements  
4NO/4NC, 5NO/3NC/6NO/2NC/7NO/7NC

# Interfaces

## Isolated I/O Opto Carrier, 35 or 32 DIN Rail

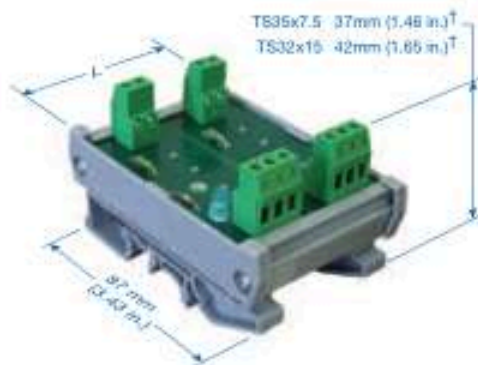

### I/O Isolated

Mount standard opto coupler input/output (I/O) modules in a high density arrangement for logic output to field devices, or for input of field data to the controller. I/O modules optically isolate ICs and PLCs from damaging field voltage spikes and line noise, while controlling up to 3 Amp field current with less than 20mA logic current. Altech I/O Module Carriers can accept up to 16 industry standard 0.6 in. (15.24mm) I/O modules in any combination: Input, Output, AC or DC from most manufacturers.

- Screw-Cage Clamp Connection
- Integral Sockets, Retaining Nut
- Field Voltage Rating: 280V AC/DC<sup>a</sup>
- LED Indication, Fuse Protection
- DIN Rail Mount, Panel Mount Available

*Custom designs can be accommodated!*

Low current LED with dropping resistor for high resistance pull-up and low logic sink/source current requirements.

#### Technical Information

Fuse Rating......5A/125C AC<sup>b</sup>  
 Wire Range .....0.5-4 mm<sup>2</sup> / 22-12 AWG  
 Torque .....0.5-4 Nm / 4 lbs-in.  
 Stripping Length ...8 mm

Part Number	Type	Position	Logic Voltage	LED	Module Length (L) in mm (in)
8954.0/B	I/O I-1B	1 Position	5V DC	Green	34.5 (1.36)
8954.0/E	I/O I-1E	1 Position	15V DC	Yellow	34.5 (1.36)
8954.0/G	I/O I-1G	1 Position	24V DC	Red	34.5 (1.36)
8955.0/B	I/O I-2B	2 Position	5V DC	Green	57.8 (2.28)
8955.0/E	I/O I-2E	2 Position	15V DC	Yellow	57.8 (2.28)
8955.0/G	I/O I-2G	2 Position	24V DC	Red	57.8 (2.28)
8956.0/B	I/O I-4B	4 Position	5V DC	Green	114 (4.49)
8956.0/E	I/O I-4E	4 Position	15V DC	Yellow	114 (4.49)
8956.0/G	I/O I-4G	4 Position	24V DC	Red	114 (4.49)
8957.0/B	I/O I-8B	8 Position	5V DC	Green	226 (8.90)
8957.0/E	I/O I-8E	8 Position	15V DC	Yellow	226 (8.90)
8957.0/G	I/O I-8G	8 Position	24V DC	Red	226 (8.90)

<sup>a</sup> Fuse rating limits field side rating.  
 - PCB Traces, Field Side: 10A/300V  
 - PCB Traces, Logic Side: 1A with 5A Bus  
 - Terminal Blocks: 15A/300V

<sup>†</sup> Dimension is to top board, add height of relay to determine clearance.

<sup>b</sup> 3A/250V fuse available, please consult Altech.

### Standard Pinout

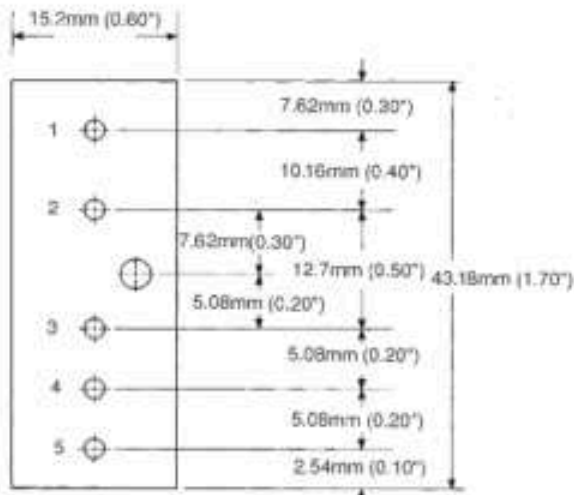

### Standard Pinout

The I/O Module pin utilization information listed below is intended for use only as a guide. For specific applications, please use only the module manufacturer's published specifications.

#### Pins 1 & 2: Field Connections

- AC Output to field load, inductive up to 3.5A at nominal 24V AC, 120V AC or 240V AC. AC hot to either pin, field load on other pin.
- DC Output to field load (inductive OK with commutating diode). Some modules polarized with pin #1 positive (+). Standard output voltages 60V DC (5-60), 200V DC (10-200).
- AC Input of field data to the logic, 10mA max at nominal 24V AC (18-36), 120V AC (90-140) and 240V AC (90-280), Field signal to either pin.
- DC Input of field data to the logic, some modules dual rated AC/DC, other nominal 5-28V DC (min. 4, max. 32), and nominal 12-48V DC (min. 10, max. 60). Some modules polarized with pin #1 (+).

#### Pin 3: VCC Logic Power

- Standard modules are available in three nominal logic voltages: 5V DC (normally min. 3 to max. 6), 15V DC (12 to 18) and 24V DC (20 to 30).

#### Pin 4: Logic Signal

- Output - Logic ground (sink) on pin #4 closes output circuit (pin #1 to pin #2 normally open, shorts with sink on input pin #4). A few positive-logic modules are available.
- Input - Field signal to pins #1 and #2 gives 20-25mA sink at pin #4 (to pin #5).

#### Pin 5: Logic Ground

- On input modules only (no pin #5 on output modules).

### I/O Isolated Positions

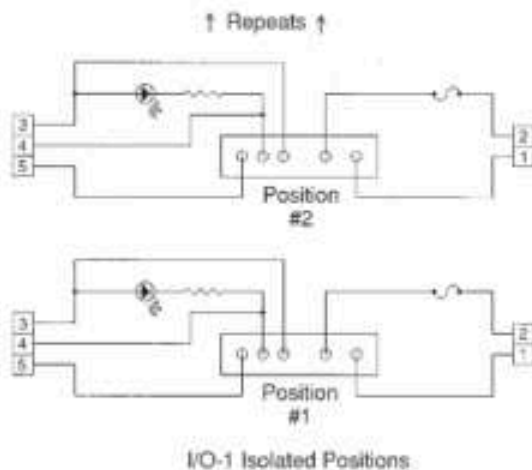

# Interfaces

## Bussed I/O Opto Carrier, 35 or 32 DIN Rail



### I/O Bussed

Mount standard opto coupler input/output (I/O) modules in a high density arrangement for logic output to field devices, or for input of field data to the controller. I/O modules optically isolate ICs and PLCs from damaging field voltage spikes and line noise, while controlling up to 3 Amp field current with less than 20mA logic current. Altech I/O Module Carriers can accept up to 16 industry standard 0.6 in. (15.24mm) I/O modules in any combination: Input, Output, AC or DC from most manufacturers.

- Screw-Cage Clamp Connection
- Integral Sockets, Retaining Nut
- Field Voltage Rating: 280V AC/DC<sup>a</sup>
- LED Indication, Fuse Protection
- DIN Rail Mount, Panel Mount Available

*Custom designs can be accommodated!*

Logic status LED which uses the I/O module impedance as its dropping resistor.

#### Technical Information

Fuse Rating.....5A/125C AC<sup>b</sup>  
 Wire Range .....0.5-4 mm<sup>2</sup> / 22-12 AWG  
 Torque .....0.5-4 Nm / 4 lbs-in.  
 Stripping Length ...8 mm

Part Number	Type	Position	Logic Voltage	LED	Module Length (L) in mm (in)
8956.0	I/O B-4	4 Position	5 to 24V DC	Green	114 (4.49)
8959.0	I/O B-8	8 Position	5 to 24V DC	Green	183 (7.20)
8861.0	I/O B-16	16 Position	5 to 24V DC	Green	363 (14.30)

<sup>a</sup> Fuse rating limits field side rating.  
 - PCB Traces, Field Side: 10A/300V  
 - PCB Traces, Logic Side: 1A with 6A Bus  
 - Terminal Blocks: 15A/300V

<sup>†</sup> Dimension is to top board, add height of relay to determine clearance.

<sup>b</sup> 3A/250V fuse available, please consult Altech.

### Standard Pinout

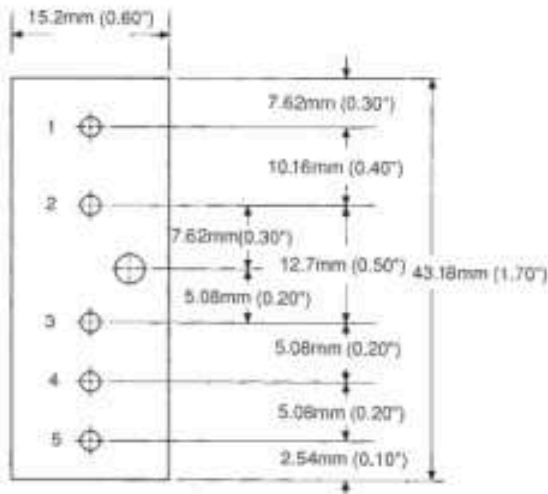

### Standard Pinout

The I/O Module pin utilization information listed below is intended for use only as a guide. For specific applications, please use only the module manufacturer's published specifications.

#### Pins 1 & 2: Field Connections

- AC Output to field load, inductive up to 3.5A at nominal 24V AC, 120V AC or 240V AC. AC hot to either pin, field load on other pin.
- DC Output to field load (inductive OK with commutating diode). Some modules polarized with pin #1 positive (+). Standard output voltages 60V DC (5-60), 200V DC (10-200).
- AC Input of field data to the logic, 10mA max at nominal 24V AC (18-36), 120V AC (90-140) and 240V AC (90-280), Field signal to either pin.
- DC Input of field data to the logic, some modules dual rated AC/DC, other nominal 5-28V DC (min. 4, max. 32), and nominal 12-48V DC (min. 10, max. 60). Some modules polarized with pin #1 (+).

#### Pin 3: VCC Logic Power

- Standard modules are available in three nominal logic voltages: 5V DC (normally min. 3 to max. 6), 15V DC (12 to 18) and 24V DC (20 to 30).

#### Pin 4: Logic Signal

- Output - Logic ground (sink) on pin #4 closes output circuit (pin #1 to pin #2 normally open, shorts with sink on input pin #4). A few positive-logic modules are available.
- Input - Field signal to pins #1 and #2 gives 20-25mA sink at pin #4 (to pin #5).

#### Pin 5: Logic Ground

- On input modules only (no pin #5 on output modules).

### I/O Bussed Positions

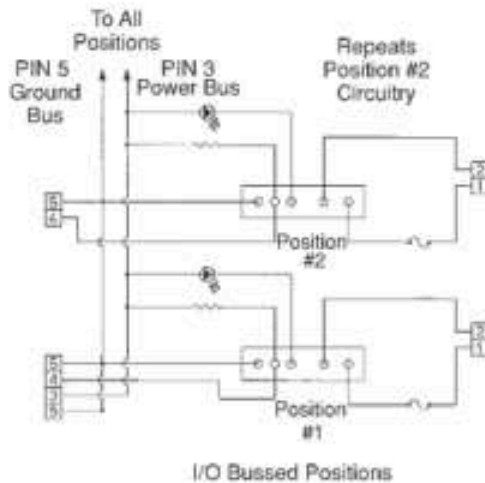

# PCB Mounting Tracks

## Narrow & Wide Mounting Track Extrusion and Components

Mount standard or custom printed circuit boards in Mounting Tracks which can be conveniently DIN rail or panel mounted in your control panel or cabinet. These are the same tracks used for Altech interface modules. We now make them available to you to house and protect your custom boards, etc. Tracks are easily cut to size or can be ordered pre-cut to specific lengths. They are easily assembled from standard components and snap onto 35mm DIN rail or can be panel mounted.

Each track has two sets of printed circuit board guides to accept two alternate board widths.

End Sections hold printed circuit boards securely in place and keep out foreign objects.

### MOUNTING

When mounting extrusions on DIN rail, order two or more DIN Rail mounting feet. These feet slide into grooves on the extrusion. Then attach two DIN Rail Mount End Sections with help of EPS screws.

To panel mount, order two Panel Mount End Sections (and EPS screws), each with an integral mounting flange with a 6 x 8mm (.24 x .32 in.) hole slot.

If desired, tracks can be direct mounted using double sided tape. Order two DIN rail mount end sections (and EPS screws).

- Standard Lengths: 1m (3'-3") or 2m (6'-6")
- Track Material: PVC
- Temperature Limit:  
Short Term - 80°C (176°F)  
Continuous - 70°C (158°F)
- End Section, Foot Material: Polyamide
- Preassembled, Precut Lengths Available
- Tracks Accept Standard MT2 Marking Tags

### Sizing Information

#### Printed Circuit Board Width

Track Type	High Guide (HG)
MTGTK1	73 ± 1mm (2.9 ± 0.05 in.)

#### Mounting Track Extrusion "Cut-to-Size" Formula

Extrusion Length = Printed Circuit Board Length - 4.5mm (.175 in.)

For PC Board Widths 73mm (2.9 in.)



#### Mounting Track

- 1 meter, grey
- 2 meter, grey
- 1 meter, green\*
- 2 meter, green\*

Part Number	Std. Pk.
MTGTK1/1M	5
MTGTK1	5
MTGTK1/1M/G	5
MTGTK1/G	5

#### Accessories

DIN Rail Mount End Section, grey	EPDR1	100
DIN Rail Mount End Section, green*	EPDR1/G	100

DIN Rail Mounting Foot, grey	MTGF1	100
DIN Rail Mounting Foot, green*	MTGF1/G	100

Panel Mount End Section, grey	EPDP1	100
Panel Mount End Section, green*	EPDP1/G	100

DIN Rail / Panel Mount End Section Screws #4x1/2", Phillips Pan head (2 required per end section)	EPS	200
---------------------------------------------------------------------------------------------------------	-----	-----

Marking Tags	MT2	100
--------------	-----	-----

### Narrow Mounting Track

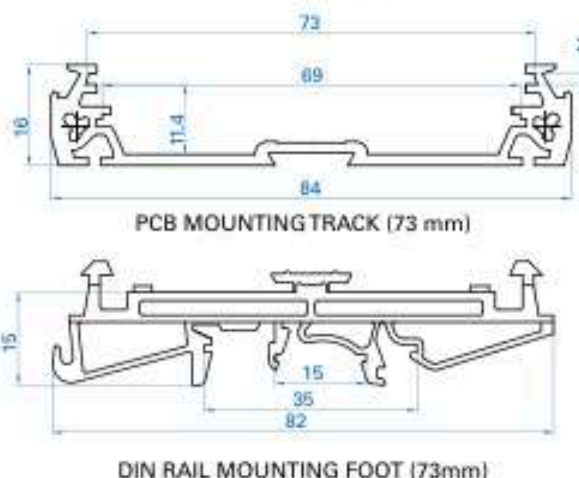

\* Green color available on request.  
Contact Altech for more information.

# PCB Mounting Tracks

## Narrow & Wide Mounting Track Extrusion and Components

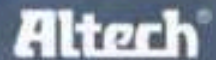

For PC Board Widths 110mm (4.9 in.)



### Panel Mount Details

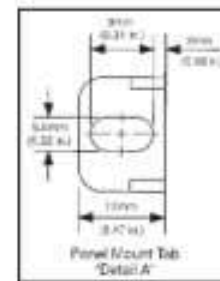
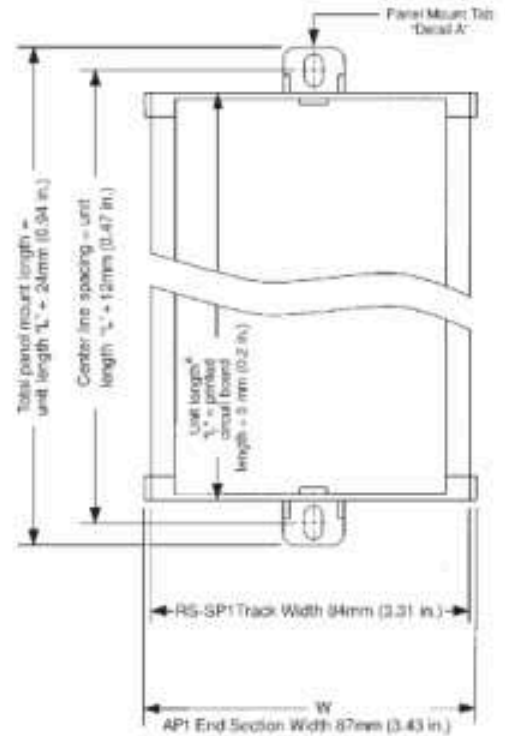

#### Mounting Track

- 1 meter, grey
- 2 meter, grey
- 1 meter, green\*
- 2 meter, green\*

Part Number	Std. Pk.
MTGTK2/1M	5
MTGTK2	5
MTGTK2/1M/G	5
MTGTK2/G	5

#### Accessories

DIN Rail Mount End Section, grey	EPDR2	100
DIN Rail Mount End Section, green*	EPDR2/G	100
DIN Rail Mounting Foot, grey	MTGF2	100
DIN Rail Mounting Foot, green*	MTGF2/G	100
Panel Mount End Section, grey	EPDP2	100
Panel Mount End Section, green*	EPDP2/G	100
DIN Rail / Panel Mount End Section Screws #4x1/2", Phillips Pan head (2 required per end section)	EPS	200
Marking Tags	MT2	100

### Wide Mounting Track

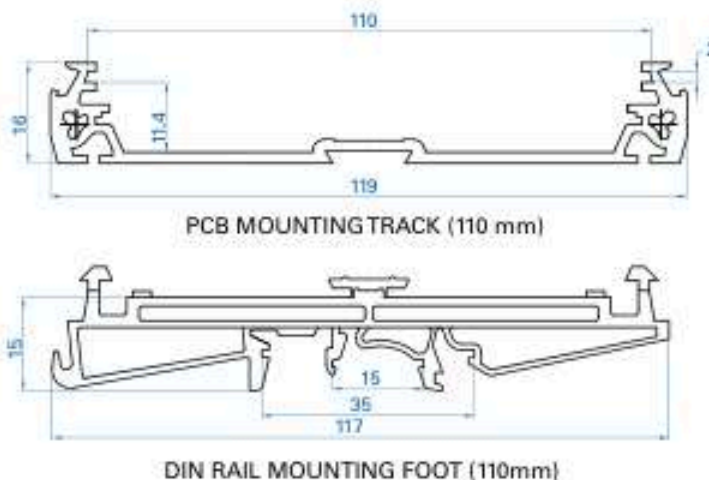

### Sizing Information

#### Printed Circuit Board Width

Track Type	High Guide (HG)
MTGTK2	110 ± 1mm (4.3 ± 0.05 in.)

#### Mounting Track Extrusion "Cut-to-Size" Formula

Extrusion Length = Printed Circuit Board Length - 4.5mm (.175 in.)

\*Also applies for DIN Rail Mount Unit

# INDUSTRIAL RELAYS

## Industrial Electromagnetic Relays

Industrial electromagnetic relays are used mainly in industrial and power automation applications, in signaling controls, safety and protection systems and control and electric drives systems.



### Features:

- DPDT, 3PDT and 4PDT contact configuration
- DC Coil voltages from 5VDC to 220V DC
- AC coil voltages from 6VAC to 240V AC 50/60 Hz
- Din Rail Plug in Socket are standard
- Rated load current: 5A/250V AC to 16A/250V AC rating  
5A/24V DC to 16A/24VDC DC1 rating
- Test button with (K) or without block function (W)
- Built in LED light indicator (L)
- Surge suppression element with diode (D) or varistor (V)
- Approved for railroad applications (DE)
- Silver Nickel (AgNi) cadmium free contact material
- UL and CSA recognized relays
- ROHS2 and REACH compliance

## Miniature Electromagnetic Relays

Miniature electromagnetic relays are used in many interface applications, standard automation projects, lighting control systems, emergency lighting applications, building application projects, food processing equipment control and many other electrical system applications.



### Features:

- Standard SPDT, DPDT contact configuration
- DC Coil voltages from 3VDC to 110V DC
- AC coil voltages from 12VAC to 240V AC 50/60 Hz
- PCB mounting with socket or direct PCB solder
- Din Rail Plug in Socket are standard
- Rated load current: 8A/250V AC (DPDT) or 16A/250V AC (SPDT) rating;  
8A/24V DC (DPDT) or 16A/24VDC (SPDT) DC1 rating
- Silver Nickel (AgNi) cadmium free contact material
- UL and CSA recognized relays
- ROHS2 and REACH compliance

## Slimline Interface Relays

Slimline interface relays are used for PLC system and industrial automation applications, panel builders, machinery builders, time relays, office equipment and other applications that require a high switching capability in a small space.



### Features:

- Standard SPDT contact configuration
- Standard 5 mm width
- DC Coil voltages from 5VDC to 60V DC
- Vertical or Horizontal configuration
- Sealed for Soldering and cleaning
- Can be used with Din rail socket or PCB mountable
- Rated load current
- 6A / 250V AC or 0.05A / 30V AC gold plated) rating
- 6A / 24V DC or 0.05A / 36V DC gold plated) rating
- 4A max for Solid state relays
- Silver Tin Oxide (AgSnO2) cadmium free contact material
- Gold plated contact (AgSnO2/Au 3µm) available
- UL recognized
- ROHS2 and REACH compliance

## Subminiature Electromagnetic and Solid State Modules

Subminiature electromagnetic relays are used for PLC systems and industrial automation applications, panel builders, equipment builders and other applications that require a high switching capability in a small space. The Altech slim line interface relays can be used as a universal interface between the controller and the actuator to switch loads between 1 mA and 6A. They are available with electromechanical contacts or solid state configuration. Installation time is greatly reduced when a pre-assembled relays and sockets combination is used. Replacement relays and sockets are available from stock. Additional accessories include colored coded jumpers, spacers and markers (unmarked or marked based on the customer specification) for identification purposes.



### Features:

- Standard SPDT contact configuration
- Space-saving 6.2 mm width
- Only 85 mm in height from DIN rail
- DC Coil voltages from 5VDC to 110V DC
- AC coil voltages from 6VAC to 240V AC 50/60 Hz
- Pre-assembled relay and DIN mount socket
- Screw clamp or Spring clamp terminals
- Universal AC/DC socket with built-in surge suppression and green LED
- Rated load current
- 6A / 250V AC or 0.05A / 30V AC gold plated) rating
- 6A / 24V DC or 0.05A / 36V DC gold plated) rating
- 4A max for Solid state relays
- Silver Tin Oxide (AgSnO2) cadmium free contact material
- Gold plated contact (AgSnO2/Au 3µm) available
- UL recognized
- ROHS2 and REACH compliance

## Relays for Photovoltaic Systems

The Altech photovoltaic relays are suitable to be integrated in the solar converter to switch the DC voltage and current generated by the solar panels supplying the generated electricity to the electrical network. This requires an interface between the solar converter and the power grid. The circuit isolation gap between the converter and the power grid must have a contact gap of  $\geq 1.5\text{mm}$  (according to safety standard DIN VDE 0126-1-1). Altech offers two different relays to meet this requirement.



### Features:

- Standard DPST (2 NO) contact configuration
- DC Coil voltages from 5VDC to 110V DC
- Rated load current
- 35A / 250V AC or 48A / 250V AC
- 35A / 24V DC or 48A / 24V DC
- Contact gap  $>1.75\text{ mm}$  ; Holding power 1W
- Silver Tin Oxide (AgSnO2) cadmium free contact material
- Compact size, PCB mounting
- UL recognized
- ROHS2 and REACH compliance

MOUNTING OPTIONS					COIL			TYPE OF RELAY	NUMBER AND TYPE OF CONTACTS							RATED CURRENT [A]									
Direct PCB mounting	With plug-in socket PCB mounting	Panel mounting	35 mm rail mount acc. To PN-EN 60715	Others	AC	DC	AC/DC		SPDT	SPST(1NO)	SPST(1NC)	DPDT	DPST(2NO)	DPST(2NC)	3PDT	3PST(3NO)	4PDT	5	10	15	20	25	30		
<b>Industrial Electromagnetic Relays</b>																									
								R2																12	
								R3																10	
								R4																6	
								RY2																12	
								R2M																5	
								RUC																16	
								R15 - DPDT																10	
								R15 - 3PDT																10	
								R15 - 4PDT																10	
<b>Miniature Electromagnetic Relays</b>																									
								RM40																5/8"	
								RM50																12	
								RM84																9	
								RM85																16	
								RM87																12	
<b>Slimline Interface Relays</b>																									
								RM699B																6	
								RSR30-...-D1-24-010-1																1	
								RSR30-...-A1-24-020-1																2	
								RSR30-...-D1-04-025-1																2.5	
								RSR30-...-D1-02-040-1																4	
<b>Subminiature Electromagnetic and Solid State Modules</b>																									
								PI6-1P																6	
								PI6-1T																1	
								PI6-1OC																1	
								PIR6W-1PS-...																max 6	
								PIR6WB-1PS-...*																max 6	
<b>Relay Socket Combinations</b>																									
								PI84 with socket GZT80																8	
								PI85 with socket GZT80																16	
								PI84 with socket GZM80																8	
								PI85 with socket GZM80																16	
								PIR2 with socket GZM2																12	
								PIR3 with socket GZM3																10	
								PIR4 with socket GZM4																6	
								PIR2M with socket GZ2																5	

\* SPDT 5 A; SPST (1NO) 8A. \*\*spring clamp socket. \*\*\* for more information see data sheet.

# R2, R3, R4

## Industrial Electromagnetic Relays

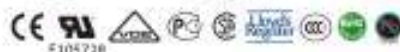

- Compact size
- Relays of general application
- Cadmium - free contacts
- AC and DC coils
- For plug-in sockets, 35 mm rail mount or on panel mounting \*
- WT (mechanical indicator + lockable front test button) - standard features of relays for plug-in sockets. Relays may be provided with the test buttons (no latching) and plugs (see page 115)
- AUCOTEAM GmbH Berlin - railway standards.

### Contact Data

	R2	R3	R4
<b>Number and type of contacts</b>	<b>DPDT</b>	<b>3PDT</b>	<b>4PDT</b>
Contact material	AgNi**	AgNi**	AgNi**
Rated / max. switching voltage AC	250 V / 440 V	250 V / 440 V	250 V / 250 V
Min. switching voltage	10 V	10 V	10 V
Rated load (capacity)	12 A / 250 V AC	10 A / 250 V AC	6 A / 250 V AC
AC1	3 A / 120 V; 1.5 A / 240 V (B300)	3 A / 120 V; 1.5 A / 240 V (B300)	1.5 A / 120 V; 0.75 A / 240 V (C300)
AC15	370 W (single-phase motor)	370 W (single-phase motor)	125 W (single-phase motor)
AC3	12 A / 24 V DC (see Fig. 3.1)	10 A / 24 V DC (see Fig. 3.2)	6 A / 24 V DC (see Fig. 3.3)
DC1	0.22 A / 120 V; 0.1 A / 250 V (R300)	0.22 A / 120 V; 0.1 A / 250 V (R300)	0.22 A / 120 V; 0.1 A / 250 V (R300)
DC13			
Min. switching current	5 mA	5 mA	5 mA
Max. inrush current	24 A	20 A	12 A
<b>Rated current</b>	<b>12 A</b>	<b>10 A</b>	<b>6 A</b>
Max. breaking capacity AC1	3000 VA	2500 VA	1500 VA
Min. breaking capacity	0.3 W	0.3 W	0.3 W
Contact resistance	≤ 100 mΩ	≤ 100 mΩ	≤ 100 mΩ
Max. operating frequency			
• at rated load AC1	1200 cycles/hour	1200 cycles/hour	1200 cycles/hour
• no load	18000 cycles/hour	18000 cycles/hour	18000 cycles/hour

### Coil Data

Rated voltage	50/60 Hz AC	6 ... 240 V	6 ... 240 V	6 ... 240 V
DC	5 ... 220 V	5 ... 220 V	5 ... 220 V	
Must release voltage	AC: ≥ 0.2 U <sub>n</sub> ; DC: ≥ 0.1 U <sub>n</sub>	AC: ≥ 0.2 U <sub>n</sub> ; DC: ≥ 0.1 U <sub>n</sub>	AC: ≥ 0.2 U <sub>n</sub> ; DC: ≥ 0.1 U <sub>n</sub>	
Operating range of supply voltage	see page 54	see page 54	see page 54	
Rated power consumption AC	1.6 VA	1.6 VA	1.6 VA	
DC	0.9 W	0.9 W	0.9 W	

### Insulation

Insulation rated voltage	250 V AC	250 V AC	250 V AC
Rated surge voltage	4000 V 1.2 / 50 μs	with AC coils: 2500 V 1.2 / 50 μs with DC coils: 4000 V 1.2 / 50 μs	2500 V 1.2 / 50 μs
Overvoltage category	III	III	III
Insulation pollution degree	3	3	2
Dielectric strength			
• between coil and contacts	2500 V AC type of insulation: basic	2500 V AC type of insulation: basic	2500 V AC type of insulation: basic
• contact clearance	1500 V AC type of clearance: micro-disco.	1500 V AC type of clearance: micro-disco.	1500 V AC type of clearance: micro-disco.
• pole - pole	2500 V AC type of insulation: basic	2500 V AC type of insulation: basic	2500 V AC type of insulation: basic
Contact - coil distance			
• clearance	≥ 2.5 mm	≥ 2.5 mm	≥ 1.6 mm
• creepage	≥ 4 mm	≥ 4 mm	≥ 3.2 mm

### General data

Operating / release time (typical)	AC: 10 ms / 8 ms; DC: 13 ms / 3 ms	AC: 10 ms / 8 ms; DC: 13 ms / 3 ms	AC: 10 ms / 8 ms; DC: 13 ms / 3 ms
Electrical life			
• resistive AC1	> 10 <sup>7</sup> ; 12 A, 250 V AC see Fig. 2.1	> 10 <sup>7</sup> ; 10 A, 250 V AC see Fig. 2.2	> 10 <sup>7</sup> ; 6 A, 250 V AC see Fig. 2.3
• cosφ			
Mechanical life (cycles)	> 2 x 10 <sup>7</sup>	> 2 x 10 <sup>7</sup>	> 2 x 10 <sup>7</sup>
Dimensions (L x W x H)	27.5 x 21.2 x 35.6 mm	27.5 x 21.2 x 35.6 mm	27.5 x 21.2 x 35.6 mm
Weight	35 g	35 g	35 g
Ambient temperature			
• storage	-40...+85 °C	-40...+85 °C	-40...+85 °C
• operating	AC: -40...+55 °C; DC: -40...+70 °C	AC: -40...+55 °C; DC: -40...+70 °C	AC: -40...+55 °C; DC: -40...+70 °C
Cover protection category	IP 40 PN-EN 60529	IP 40 PN-EN 60529	IP 40 PN-EN 60529
Environmental protection	RTI PN-EN 116000-3	RTI PN-EN 116000-3	RTI PN-EN 116000-3
Shock resistance (NO/NC)	10 g / 5 g	10 g / 5 g	10 g / 5 g
Vibration resistance	5 g 10...150 Hz	5 g 10...150 Hz	5 g 10...150 Hz
Solder bath temperature	max. 270 °C	-	max. 270 °C
Soldering time	max. 5 s	-	max. 5 s

\* PCB or threaded bolt versions contact Altech Corp.

\*\* Other contact materials (eg. gold plated) available, contact Altech Corp.

# R2, R3, R4 Industrial Electromagnetic Relays



## R2 (DPDT)

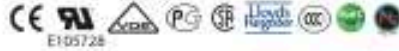

### CONNECTION DIAGRAM

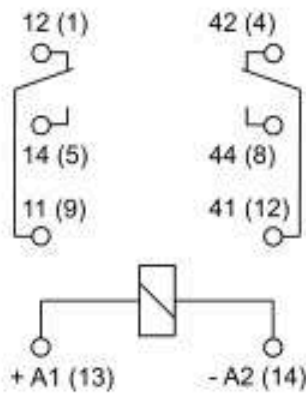

### DIMENSIONS

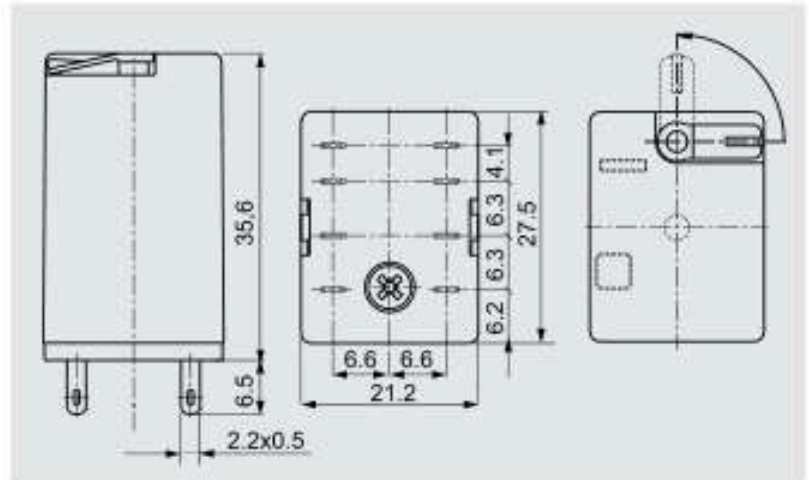

### LOAD CHARTS

Electrical life at AC resistive load. Switching frequency: 1200 cycles/hour Fig. 1.1

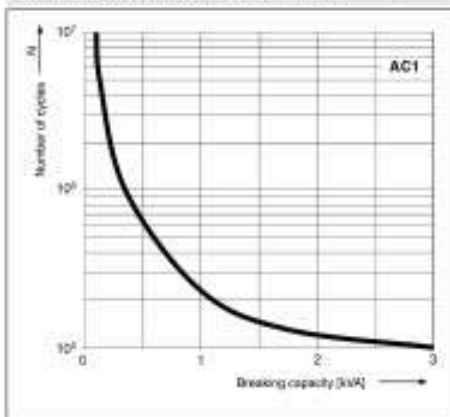

Electrical life reduction factor at AC inductive load Fig. 2.1

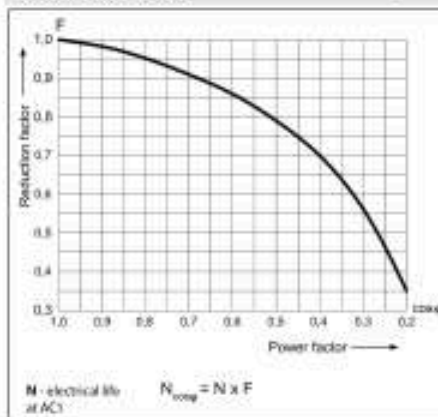

Max. DC resistive load breaking capacity Fig. 3.1

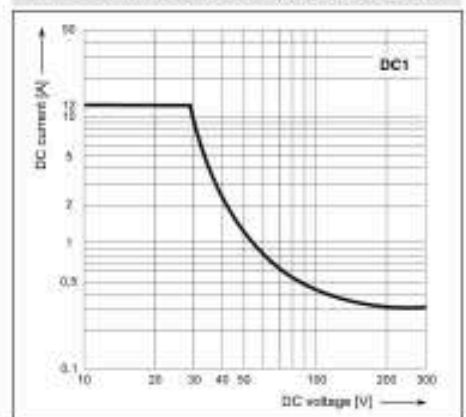

# R2, R3, R4

## Industrial Electromagnetic Relays



**R3 (3PDT)**



### CONNECTION DIAGRAM

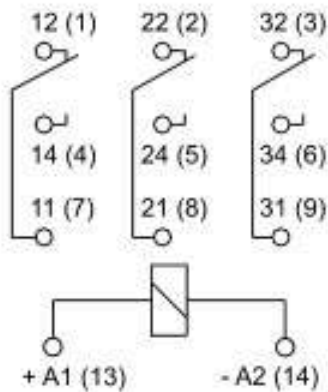

### DIMENSIONS

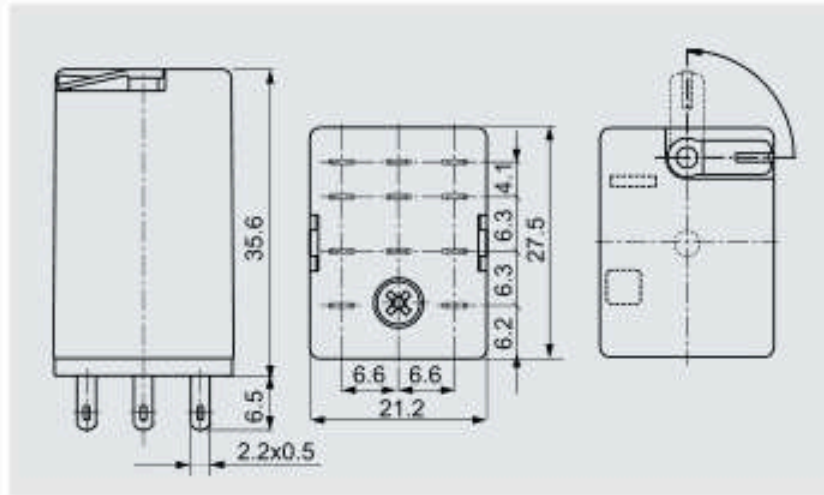

### LOAD CHARTS

Electrical life at AC resistive load. Switching frequency: 1200 cycles/hour **Fig. 1.2**

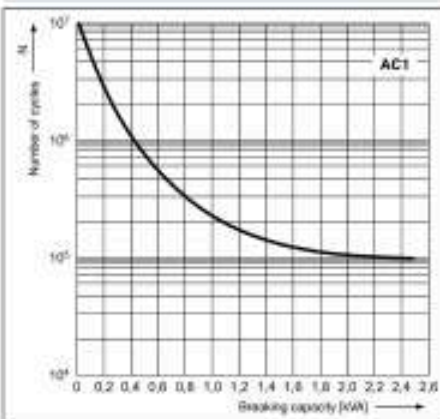

Electrical life reduction factor at AC inductive load **Fig. 2.2**

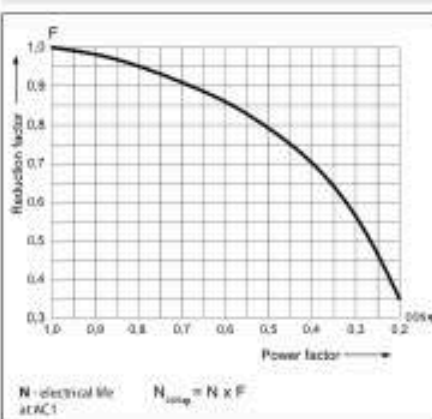

Max. DC breaking capacity **Fig. 3.2**  
 A - resistive load DC1  
 B - inductive load L/R = 40 ms

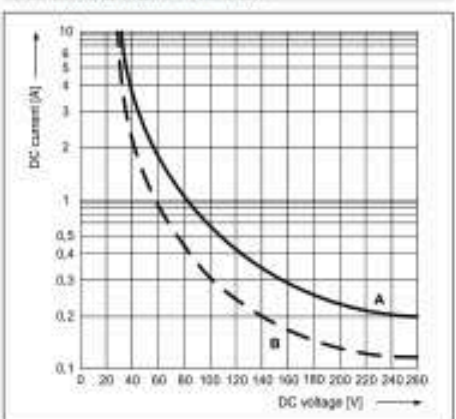

# R2, R3, R4

## Industrial Electromagnetic Relays



### R4 (4PDT)



#### CONNECTION DIAGRAM

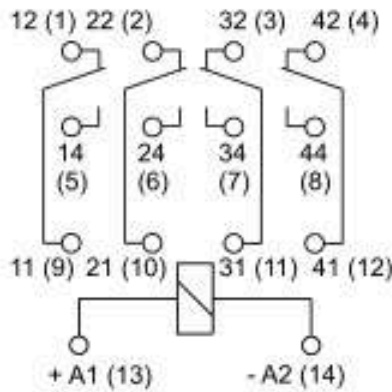

#### DIMENSIONS

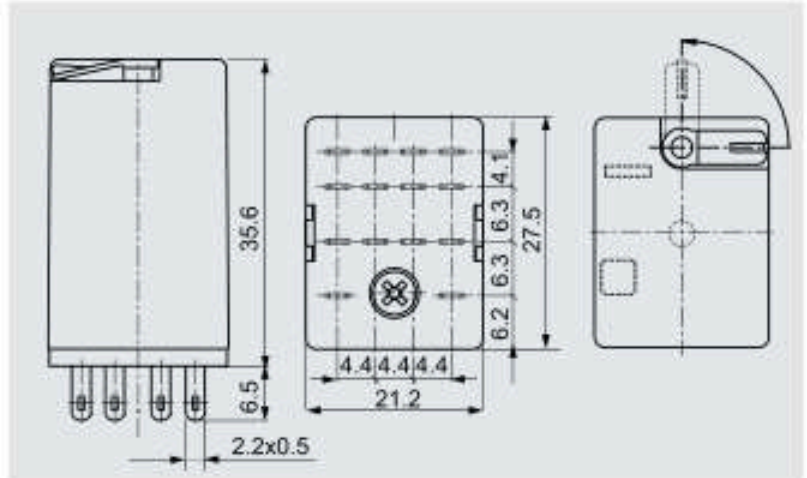

#### LOAD CHARTS

Electrical life at AC resistive load. Switching frequency: 1200 cycles/hour **Fig. 3.1**

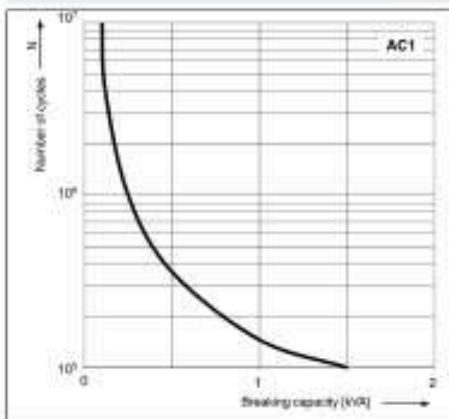

Electrical life reduction factor at AC inductive load **Fig. 2.3**

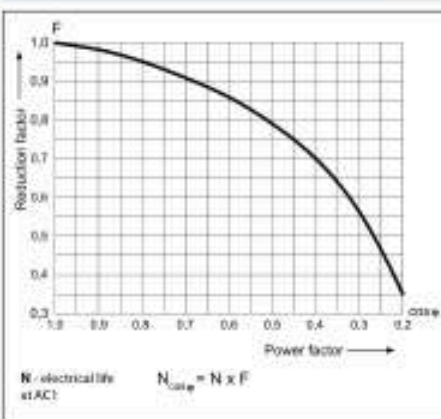

Max. DC breaking capacity **Fig. 3.3**  
A - resistive load DC1  
B - inductive load L/R = 40 ms

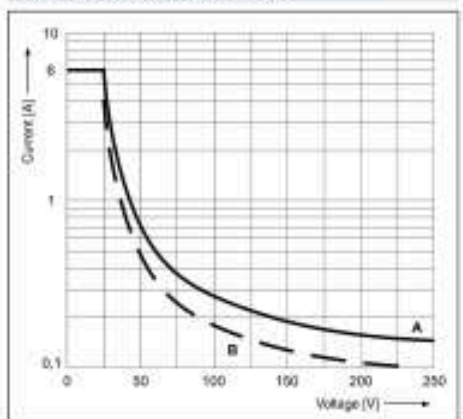

# R2, R3, R4

## Industrial Electromagnetic Relays

### R2 DPDT AC 50/60Hz & DC coil

Part Number	Coil Voltage (V)	Coil Type	Coil resistance at 20 °C in Ω	Coil operating range		Options*	
				min. (at 20°C)	max. (at 55°C)	WT	WTL
R2N-2012-23-1012-WT	12	DC	160	9.6	13.2	x	
▶ R2N-2012-23-1012-WTL	12	DC	160	9.6	13.2		x
▶ R2N-2012-23-1024-WT	24	DC	640	19.2	26.4	x	
▶ R2N-2012-23-1024-WTL	24	DC	640	19.2	26.4		x
R2N-2012-23-1110-WT	110	DC	13600	88.0	121.0	x	
R2N-2012-23-1110-WTL	110	DC	13600	88.0	121.0		x
R2N-2012-23-5024-WT	24	AC 50/60Hz	158.0	19.2	26.4	x	
▶ R2N-2012-23-5024-WTL	24	AC 50/60Hz	158.0	19.2	26.4		x
▶ R2N-2012-23-5120-WT	120	AC 50/60Hz	3770	96.0	132.0	x	
▶ R2N-2012-23-5120-WTL	120	AC 50/60Hz	3770	96.0	132.0		x
R2N-2012-23-5230-WT	230	AC 50/60Hz	16100	184.0	253.0	x	
▶ R2N-2012-23-5230-WTL	230	AC 50/60Hz	16100	184.0	253.0		x

### R3 DPDT AC 50/60Hz & DC coil

Part Number	Coil Voltage (V)	Coil Type	Coil resistance at 20 °C in Ω	Coil operating range		Options*	
				min. (at 20°C)	max. (at 55°C)	WT	WTL
R3N-2013-23-1012-WT	12	DC	160	9.6	13.2	x	
▶ R3N-2013-23-1012-WTL	12	DC	160	9.6	13.2		x
R3N-2013-23-1024-WT	24	DC	640	19.2	26.4	x	
▶ R3N-2013-23-1024-WTL	24	DC	640	19.2	26.4		x
R3N-2013-23-1110-WT	110	DC	13600	88.0	121.0	x	
R3N-2013-23-1110-WTL	110	DC	13600	88.0	121.0		x
R3N-2013-23-5024-WT	24	AC 50/60Hz	158.0	19.2	26.4	x	
R3N-2013-23-5024-WTL	24	AC 50/60Hz	158.0	19.2	26.4		x
▶ R3N-2013-23-5120-WT	120	AC 50/60Hz	3770	96.0	132.0	x	
▶ R3N-2013-23-5120-WTL	120	AC 50/60Hz	3770	96.0	132.0		x
R3N-2013-23-5230-WT	230	AC 50/60Hz	16100	184.0	253.0	x	
R3N-2013-23-5230-WTL	230	AC 50/60Hz	16100	184.0	253.0		x

### R4 DPDT AC 50/60Hz & DC coil

Part Number	Coil Voltage (V)	Coil Type	Coil resistance at 20 °C in Ω	Coil operating range		Options*	
				min. (at 20°C)	max. (at 55°C)	WT	WTL
R4N-2014-23-1012-WT	12	DC	160	9.6	13.2	x	
▶ R4N-2014-23-1012-WTL	12	DC	160	9.6	13.2		x
▶ R4N-2014-23-1024-WT	24	DC	640	19.2	26.4	x	
▶ R4N-2014-23-1024-WTL	24	DC	640	19.2	26.4		x
R4N-2014-23-1110-WT	110	DC	13600	88.0	121.0	x	
▶ R4N-2014-23-1110-WTL	110	DC	13600	88.0	121.0		x
R4N-2014-23-5024-WT	24	AC 50/60Hz	158.0	19.2	26.4	x	
▶ R4N-2014-23-5024-WTL	24	AC 50/60Hz	158.0	19.2	26.4		x
▶ R4N-2014-23-5120-WT	120	AC 50/60Hz	3770	96.0	132.0	x	
▶ R4N-2014-23-5120-WTL	120	AC 50/60Hz	3770	96.0	132.0		x
R4N-2014-23-5230-WT	230	AC 50/60Hz	16100	184.0	253.0	x	
▶ R4N-2014-23-5230-WTL	230	AC 50/60Hz	16100	184.0	253.0		x

WT = with mechanical indicator + lockable front test button

WTL = with mechanical indicator + lockable front test button + light indicator (LED)

\* other options available upon request

▶ BOLD - Regular stocked items.

# R2, R3, R4

## Industrial Electromagnetic Relays - Plug-in Sockets and Accessories

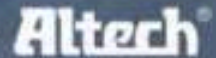

### GZT2 (for R2)

Screw terminals  
 Max. tightening moment  
 for the terminal: 0.7 Nm  
 35 mm rail mount  
 acc. to PN-EN 60715  
 or on panel mounting  
 76,3 x 27 x 42.5(80) mm\*  
 Two poles  
 12 A, 300 V AC



GZT2

#### CONNECTION DIAGRAM

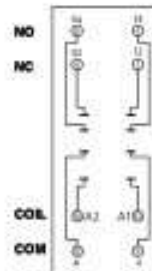

#### DIMENSIONS

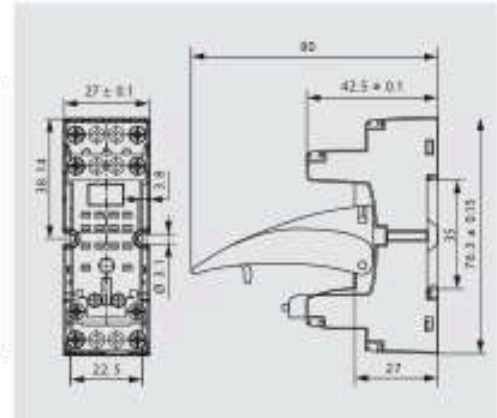

### GZM2 (for R2)

Screw terminals  
 Max. tightening moment  
 for the terminal: 0.7 Nm  
 35 mm rail mount  
 acc. to PN-EN 60715  
 or on panel mounting  
 75 x 27 x 61(82) mm\*  
 Two poles  
 12 A, 300 V AC



GZM2

#### CONNECTION DIAGRAM

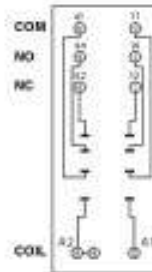

#### DIMENSIONS

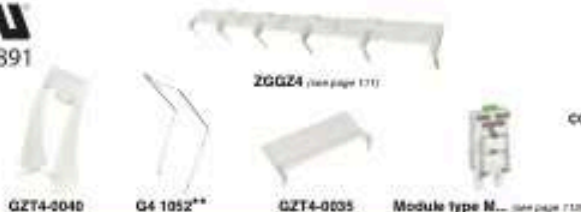
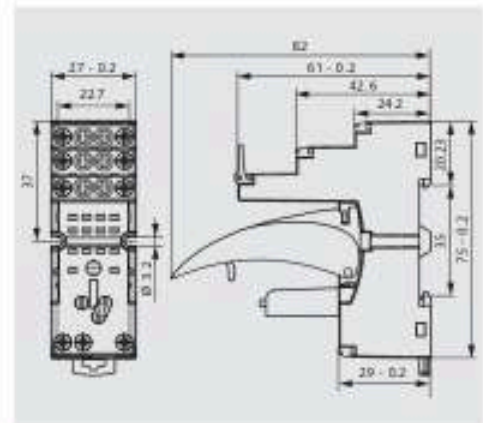

### GZT3 (for R3)

Screw terminals  
 Max. tightening moment  
 for the terminal: 0.7 Nm  
 35 mm rail mount  
 acc. to PN-EN 60715  
 or on panel mounting  
 76,3 x 27 x 42.5(80) mm\*  
 Three poles  
 10 A, 300 V AC



GZT3

#### CONNECTION DIAGRAM

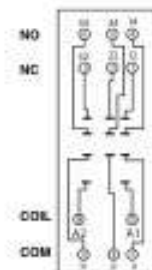

#### DIMENSIONS

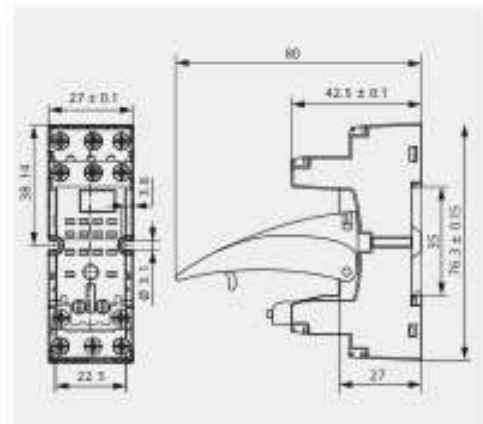

\* In parenthesis is the height of the socket with plastic retainer clip. \*\* For lower profile application.

All accessories are sold separately

# R2, R3, R4

## Industrial Electromagnetic Relays - Plug-in Sockets and Accessories

### GZM3 (for R3)

Screw terminals  
 Max. tightening moment  
 for the terminal: 0.7 Nm  
 35 mm rail mount  
 acc. to PN-EN 60715  
 or on panel mounting  
 75 x 27 x 61(82) mm\*  
 Three poles  
 10 A, 300 V AC



#### CONNECTION DIAGRAM

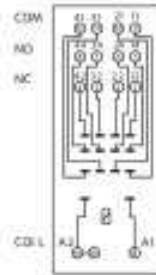

#### DIMENSIONS

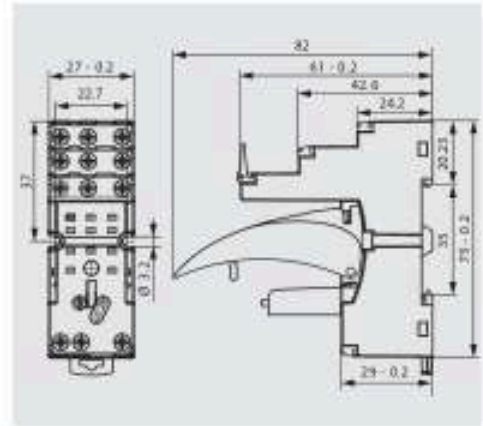

### GZT4 (for R4)

Screw terminals  
 Max. tightening moment  
 for the terminal: 0.7 Nm  
 35 mm rail mount  
 acc. to PN-EN 60715  
 or on panel mounting  
 76,3 x 27 x 42.5(80) mm\*  
 Four poles  
 6 A, 300 V AC



#### CONNECTION DIAGRAM

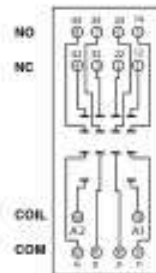

#### DIMENSIONS

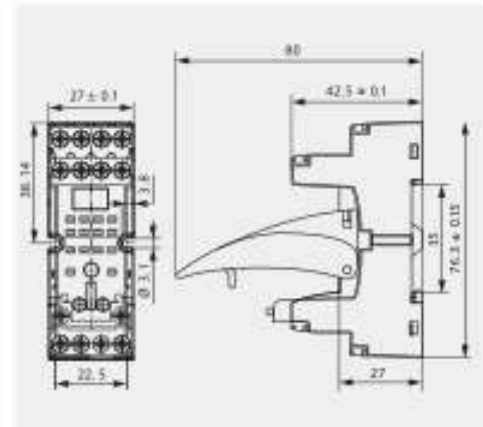

### GZM4 (for R4)

Screw terminals  
 Max. tightening moment  
 for the terminal: 0.7 Nm  
 35 mm rail mount  
 acc. to PN-EN 60715  
 or on panel mounting  
 75 x 27 x 61(82) mm\*  
 Four poles  
 6 A, 300 V AC



#### CONNECTION DIAGRAM

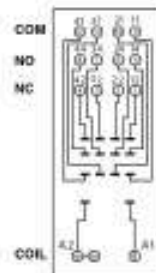

#### DIMENSIONS

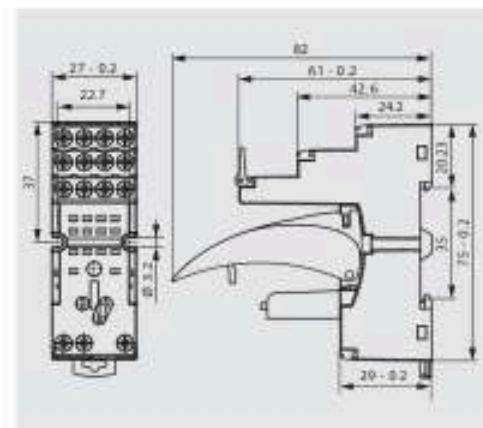

\* In parenthesis is the height of the socket with plastic retainer clip. \*\* For lower profile application.

All accessories are sold separately.

# R2, R3, R4

## Industrial Electromagnetic Relays - Plug-in Sockets and Accessories **Altech**

### GZMB2 (for R2)

Spring terminals

Max. cross section of the cables:

1 x 0,2...1,5 mm<sup>2</sup>

(1 x 24...16 AWG)

Stripping length deinsulation: 9...11 mm

35 mm rail mount

acc. to PN-EN 60715

95 x 31 x 42.5(80) mm\*

Two poles

10 A, 300 V AC



GZMB2

### CONNECTION DIAGRAM

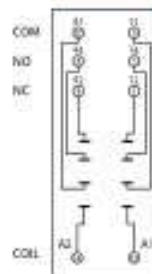

### DIMENSIONS

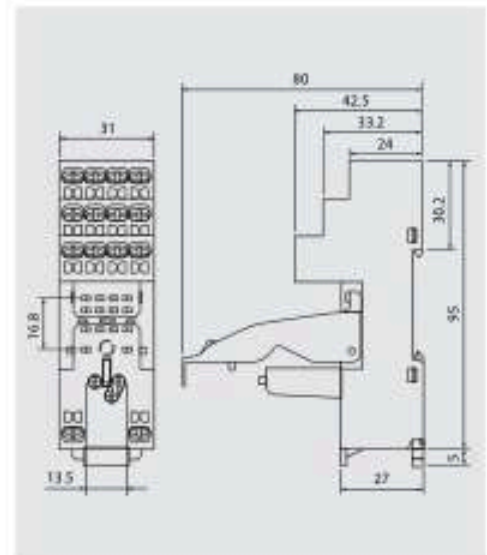

GZMB4-0040



G4-1052\*\*



TR



Module type M... (see page 172)

### GZMB4 (for R4)

Spring terminals

Max. cross section of the cables:

1 x 0,2...1,5 mm<sup>2</sup>

(1 x 24...16 AWG)

Stripping length deinsulation:

9...11 mm

35 mm rail mount

acc. to PN-EN 60715

95 x 31 x 42.5(80) mm\*

Four poles

10 A, 300 V AC



GZMB4

### CONNECTION DIAGRAM

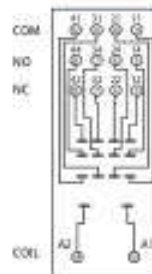

### DIMENSIONS

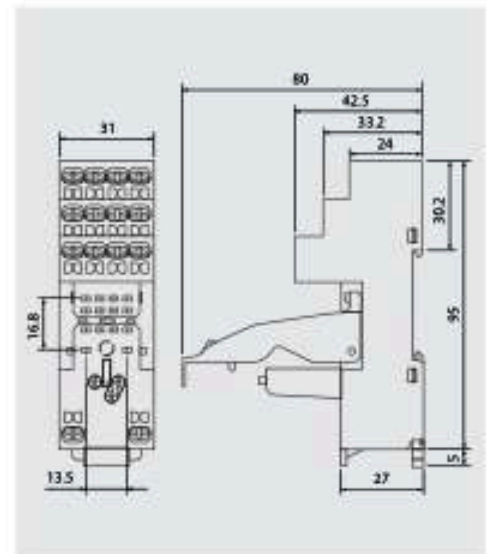

GZMB4-0040



G4-1052\*\*



TR



Module type M... (see page 172)

\* In parenthesis is the height of the socket with plastic retainer clip. \*\* For lower profile application.

All accessories are sold separately.

# R2M / RY2 / RUC

## Industrial Electromagnetic Relays



- Relays of general application
- For plug-in sockets, 35 mm rail mount or on panel mounting
- Cadmium-free contacts
- R2M and RUC also for PCB and soldering connections
- AC and DC coils available

		R2M	RY2	RUC
<b>Contact Data</b>				
<b>Number and type of contacts</b>		DPDT	DPDT	DPDT, 3PDT, DPST, 3PST
Contact material		AgNi*	AgNi*	AgNi*
Rated / max. switching voltage AC		250 V / 250 V	250 V / 440 V	400 V / 440 V
Min. switching voltage		5 V	5 V	5 V
Rated load AC1		5 A / 250 V AC	12 A / 250 V AC	16 A / 250 V AC or 10 A / 400 V AC
DC1		5 A / 24 V DC	12 A / 30 V DC	16 A / 24 V DC (see Fig. 3.3)
Min. switching current		5 mA	5 mA	5 mA
Max. inrush current			20 A	40 A
<b>Rated current</b>		5A	12A	16A
Max. breaking capacity AC1		1250 VA	3000 VA	4000 VA
Min. breaking capacity		0.3 W	0.3 W	0.3 W
Contact resistance		≈ 100 mΩ	≈ 100 mΩ	≈ 100 mΩ
Max. operating frequency				
• at rated load AC1		1200 cycles/hour	1200 cycles/hour	1200 cycles/hour
• no load		36000 cycles/hour	18000 cycles/hour	12000 cycles/hour
<b>Coil Data</b>				
Rated voltage 50/60 Hz AC		8 ... 240 V	6 ... 240 V	6 ... 240 V
DC		6 ... 110 V	5 ... 220 V	6 ... 220 V
Must release voltage		≈ 0.05 U <sub>N</sub>	AC: ≈ 0.2 U <sub>N</sub> ; DC: ≈ 0.1 U <sub>N</sub>	AC: ≈ 0.15 U <sub>N</sub> ; DC: ≈ 0.1 U <sub>N</sub>
Operating range of supply voltage		see page 62	see page 62	see page 62
Rated power consumption AC		1.2 W	1.6 W	2.8 W 50 Hz; 2.5 W 60 Hz
DC		0.9 W	0.9 W	1.5 W; 1.7 W with contact gap ≥ 3 mm
<b>Insulation</b>				
Insulation rated voltage		250 V AC	250 V AC	400 V AC
Rated surge voltage		2500 V 1.2 / 50 μs	4000 V 1.2 / 50 μs	4000 V 1.2 / 50 μs
Overvoltage category		II	II	II
Insulation pollution degree		3	3	3
Dielectric strength between coil and contacts		2000 V AC type of insulation: basic	2500 V AC type of insulation: basic	2500 V AC type of insulation: basic
• contact clearance		1000 V AC type of clearance: micro-disconnection	1000 V AC type of clearance: micro-disconnection	1500 V AC type of clearance: micro-disconnection
• pole - pole		2000 V AC type of insulation: basic	2500 V AC type of insulation: basic	2500 V AC with contact gap ≥ 3 mm, type of clearance: full-disconnection
Contact - coil distance				2500 V AC type of insulation: basic
• clearance		≈ 3 mm	≈ 2.6 mm	≈ 5 mm
• creepage		≈ 4 mm	≈ 4 mm	≈ 8 mm
<b>General data</b>				
Operating / release time (typical values)		AC: 8 ms / 7 ms; DC: 10 ms / 3 ms	15 ms / 10 ms	20 ms / 15 ms
Electrical life				
• resistive AC1		> 2 × 10 <sup>7</sup> ; 5 A, 250 V AC	> 10 <sup>7</sup> ; 12 A, 250 V AC	> 10 <sup>7</sup> ; 16 A, 250 V AC; > 10 <sup>7</sup> ; 10 A, 400 V AC
• cosφ		see Fig. 2.1	see Fig. 2.2	see Fig. 2.3
Mechanical life (cycles)		> 10 <sup>7</sup>	> 10 <sup>7</sup>	> 10 <sup>7</sup>
Motor load according to UL 508		-	-	DPDT: 1/3 HP 120 V AC, single-phase motor 1/2 HP 240 V AC, single-phase motor 3PDT: 1/3 HP 120 V AC, single-phase motor 1/2 HP 240 V AC, single-phase motor 3PDT: 1/2 HP 240 V AC, three-phase motor
Dimensions (L x W x H)		27.5 x 14 x 32.9 mm	27.5 x 21.1 x 34.5 mm	36.1 x 38.6 x 45.5 mm
Weight		22 g	35 g	80 g
Ambient temperature				
• storage		-40...+70 °C	-40...+70 °C	-40...+85 °C
• operating		-40...+55 °C	-40...+55 °C	AC: -40...+55 °C 3PDT, 3PST (NO) / 16 A (+70 °C DPDT, DPST (NO) / 16 A) DC: -40...+55 °C 3PDT, 3PST (NO) / 16 A (+70 °C 3PDT, 3PST (NO) / 10 A; DPDT, DPST (NO) / 16 A)
Cover protection category		IP 40 PN-EN 60529	IP 40 PN-EN 60529	IP 00 PN-EN 60529
Shock resistance		10 g	10 g	10 g
Vibration resistance		5 g 10...150 Hz	5 g 15...150 Hz	5 g 10...150 Hz
Solder bath temperature		max. 270 °C	-	max. 270 °C
Soldering time		max. 5 s	-	max. 5 s

\* Other contact materials (eg. gold plated) available, contact Altech Corp.



### R2M



### CONNECTION DIAGRAM

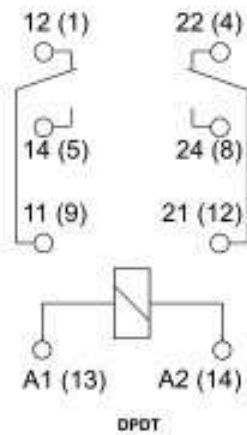

### DIMENSIONS

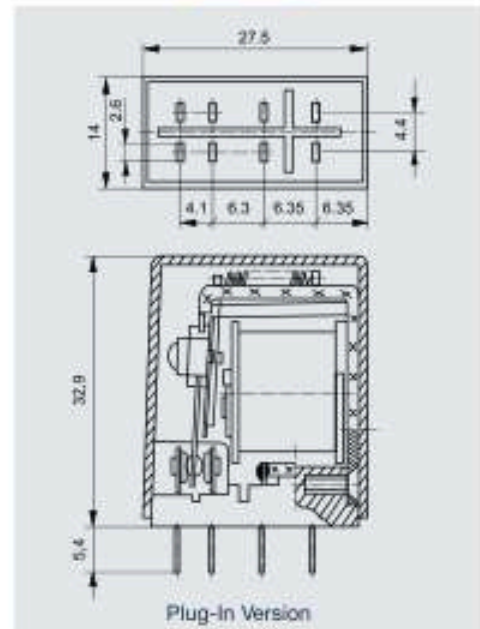

### LOAD CHARTS

Electrical life at AC resistive load. Switching frequency: 1200 cycles/hour Fig. 1.1

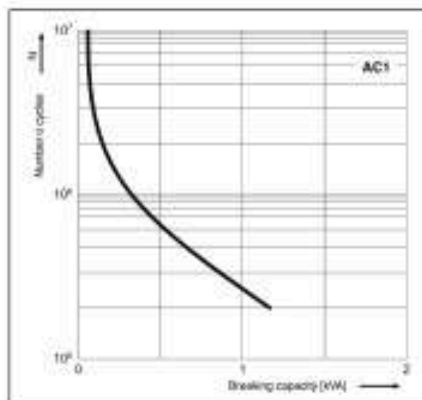

Electrical life reduction factor at AC inductive load Fig. 2.1

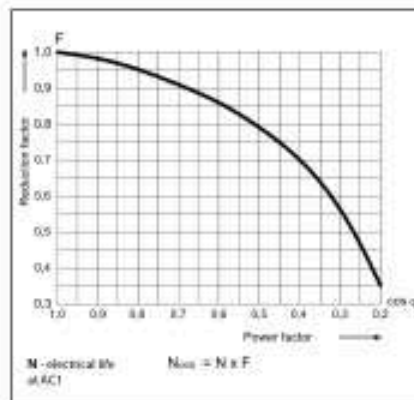

Max. DC resistive load breaking capacity Fig. 3.1

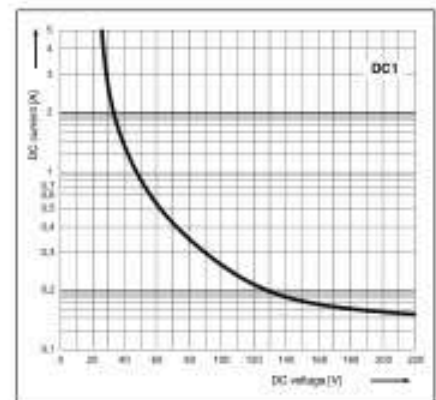

# R2M / RY2 / RUC

## Industrial Electromagnetic Relays



**RY2**



### CONNECTION DIAGRAM

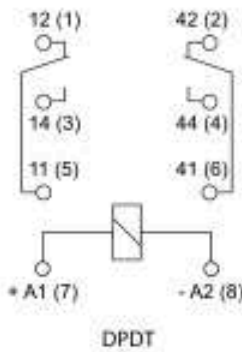

Note: the indicated polarity of the supply refers to the relays with extra equipment D - surge suppression element (diode) - for DC coils only.

### DIMENSIONS

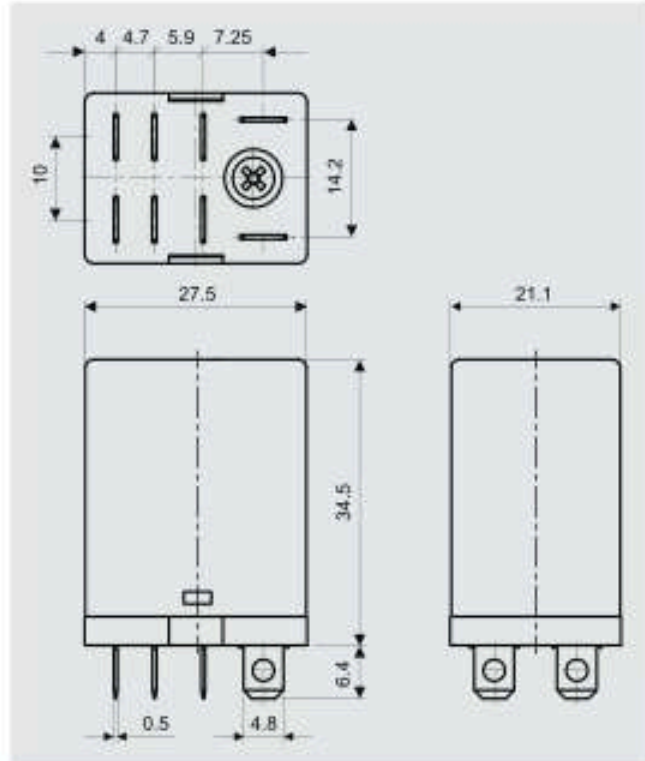

### LOAD CHARTS

Electrical life at AC resistive load. Fig. 1.2  
Switching frequency: 1 200 cycles/hour

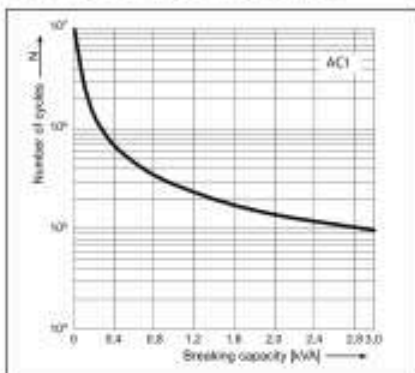

Electrical life reduction factor at AC inductive load Fig. 2.2

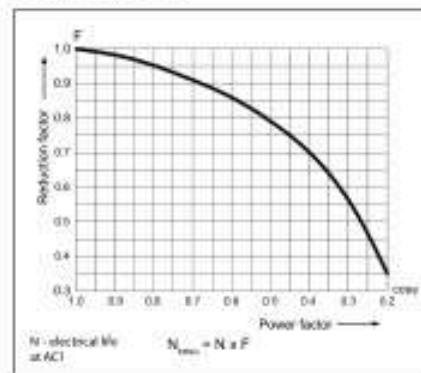

# R2M / RY2 / RUC

## Industrial Electromagnetic Relays

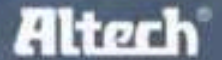

**RUC**



### CONNECTION DIAGRAM

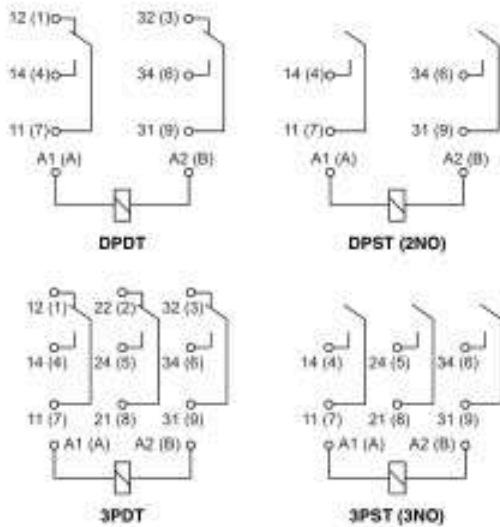

### DIMENSIONS

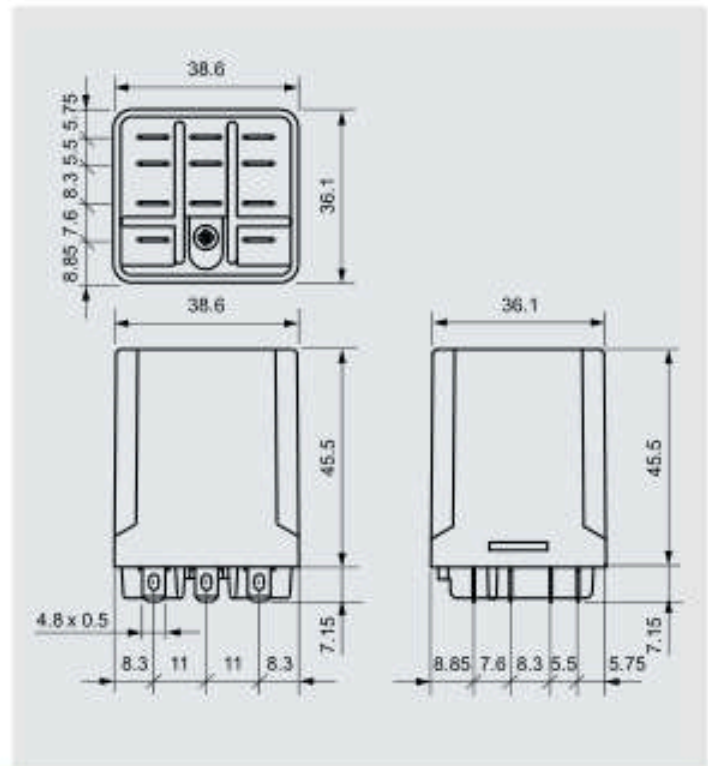

### LOAD CHARTS

Electrical life at AC resistive load.  
Switching frequency: 1200 cycles/hour

Fig. 1

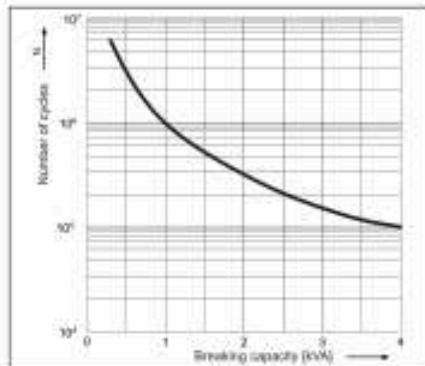

Electrical life reduction factor at AC inductive load

Fig. 2

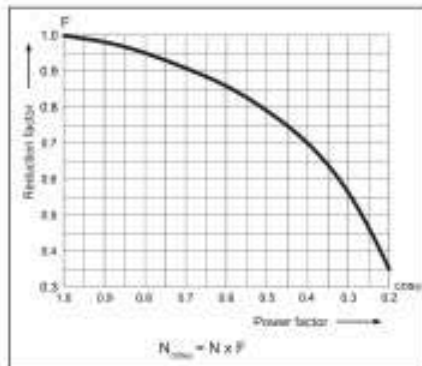

Max. DC breaking capacity  
A - resistive load DC1  
B - inductive load L/R = 40 ms

Fig. 3

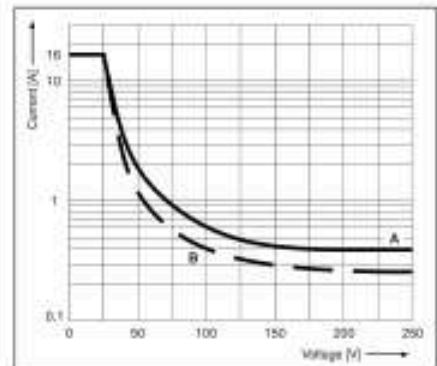

# R2M / RY2 / RUC

## Industrial Electromagnetic Relays

### R2M DPDT AC 50/60Hz & DC coil

Part Number	Coil Voltage (V)	Coil Type	Coil resistance at 20 °C in $\Omega$	Coil operating range	
				min. (at 20°C)	max. (at 55°C)
R2M-2012-23-1012	12	DC	188	9.6	13.2
► R2M-2012-23-1024	24	DC	750	19.2	26.4
R2M-2012-23-1110	110	DC	13480	88.0	121.0
► R2M-2012-23-5120	120	AC 50/60Hz	6390	96.0	132.0
R2M-2012-23-5230	230	AC 50/60Hz	21470	184.0	253.0

### RY2 DPDT AC 50/60Hz & DC coil

Part Number	Coil Voltage (V)	Coil Type	Coil resistance at 20 °C in $\Omega$	Coil operating range		Options*		
				min. (at 20°C)	max. (at 55°C)	-	L	D
► RY2-2012-26-1012	12	DC	160	9.6	13.2	x		
RY2-2012-26-1012-L	12	DC	160	9.6	13.2		x	
RY2-2012-26-1012-D	12	DC	160	9.6	13.2			x
RY2-2012-26-1012-LD	12	DC	160	9.6	13.2		x	x
► RY2-2012-26-1024	24	DC	640	19.2	26.4	x		
► RY2-2012-26-1024-L	24	DC	640	19.2	26.4		x	
RY2-2012-26-1024-D	24	DC	640	19.2	26.4			x
RY2-2012-26-1024-LD	24	DC	640	19.2	26.4		x	x
RY2-2012-26-1110	110	DC	13600	88.0	121.0	x		
RY2-2012-26-1110-L	110	DC	13600	88.0	121.0		x	
RY2-2012-26-1110-D	110	DC	13600	88.0	121.0			x
RY2-2012-26-1110-LD	110	DC	13600	88.0	121.0		x	x
RY2-2012-26-5024	24	AC 50/60Hz	158	19.2	26.4	x		
► RY2-2012-26-5024-L	24	AC 50/60Hz	158	19.2	26.4		x	
RY2-2012-26-5024-D	24	AC 50/60Hz	158	19.2	26.4			x
RY2-2012-26-5024-LD	24	AC 50/60Hz	158	19.2	26.4		x	x
► RY2-2012-26-5120	120	AC 50/60Hz	3770	96.0	132.0	x		
► RY2-2012-26-5120-L	120	AC 50/60Hz	3770	96.0	132.0		x	
RY2-2012-26-5120-D	120	AC 50/60Hz	3770	96.0	132.0			x
RY2-2012-26-5120-LD	120	AC 50/60Hz	3770	96.0	132.0		x	x
RY2-2012-26-5230	230	AC 50/60Hz	16100	184.0	253.0	x		
► RY2-2012-26-5230-L	230	AC 50/60Hz	16100	184.0	253.0		x	
RY2-2012-26-5230-D	230	AC 50/60Hz	16100	184.0	253.0			x
RY2-2012-26-5230-LD	230	AC 50/60Hz	16100	184.0	253.0		x	x

### RUC DPDT AC 50/60Hz & DC coil

Part Number	Coil Voltage (V)	Coil Type	Coil resistance at 20 °C in $\Omega$	Coil operating range		Options*		
				min. (at 20°C)	max. (at 55°C)	-	K	L
► RUC-2012-26-1012	12	DC	110	9.6	13.2	x		
RUC-2012-26-1012-K	12	DC	110	9.6	13.2		x	
RUC-2012-26-1012-L	12	DC	110	9.6	13.2			x
RUC-2012-26-1012-KL	12	DC	110	9.6	13.2		x	x
► RUC-2012-26-1024	24	DC	430	19.2	26.4	x		
RUC-2012-26-1024-K	24	DC	430	19.2	26.4		x	
RUC-2012-26-1024-L	24	DC	430	19.2	26.4			x
► RUC-2012-26-1024-KL	24	DC	430	19.2	26.4		x	x
RUC-2012-26-1110	110	DC	9200	88.0	121.0	x		
RUC-2012-26-1110-K	110	DC	9200	88.0	121.0		x	
RUC-2012-26-1110-L	110	DC	9200	88.0	121.0			x
RUC-2012-26-1110-KL	110	DC	9200	88.0	121.0		x	x
► RUC-2012-26-5120	120	AC 50/60Hz	1910	96.0	132.0	x		
RUC-2012-26-5120-K	120	AC 50/60Hz	1910	96.0	132.0		x	
RUC-2012-26-5120-L	120	AC 50/60Hz	1910	96.0	132.0			x
► RUC-2012-26-5120-KL	120	AC 50/60Hz	1910	96.0	132.0		x	x
RUC-2012-26-5230	230	AC 50/60Hz	7080	184.0	253.0z	x		
RUC-2012-26-5230-K	230	AC 50/60Hz	7080	184.0	253.0		x	
RUC-2012-26-5230-L	230	AC 50/60Hz	7080	184.0	253.0			x
► RUC-2012-26-5230-KL	230	AC 50/60Hz	7080	184.0	253.0		x	x

- = without additional features  
**K** = with test button without block function;  
**L** = with light indicator (LED)  
**D** = with surge suppression element (diode)  
 \* other options available upon request

► **BOLD** - Regular stocked items.

# R2M / RY2 / RUC

## Industrial Electromagnetic Relays

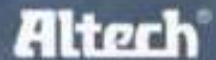

### RUC 3PDT AC 50/60Hz & DC coil

Part Number	Coil Voltage (V)	Coil Type	Coil resistance at 20 °C in Ω	Coil operating range		Options*		
				min. (at 20°C)	max. (at 55°C)	-	K	L
► <b>RUC-2013-26-1012</b>	12	DC	110	9.6	13.2	x		
RUC-2013-26-1012-K	12	DC	110	9.6	13.2		x	
RUC-2013-26-1012-L	12	DC	110	9.6	13.2			x
RUC-2013-26-1012-KL	12	DC	110	9.6	13.2		x	x
► <b>RUC-2013-26-1024</b>	24	DC	430	19.2	26.4	x		
RUC-2013-26-1024-K	24	DC	430	19.2	26.4		x	
RUC-2013-26-1024-L	24	DC	430	19.2	26.4			x
► <b>RUC-2013-26-1024-KL</b>	24	DC	430	19.2	26.4		x	x
RUC-2013-26-1110	110	DC	9200	88.0	121.0	x		
RUC-2013-26-1110-K	110	DC	9200	88.0	121.0		x	
RUC-2013-26-1110-L	110	DC	9200	88.0	121.0			x
RUC-2013-26-1110-KL	110	DC	9200	88.0	121.0		x	x
► <b>RUC-2013-26-5120</b>	120	AC 50/60Hz	1910	96.0	132.0	x		
RUC-2013-26-5120-K	120	AC 50/60Hz	1910	96.0	132.0		x	
RUC-2013-26-5120-L	120	AC 50/60Hz	1910	96.0	132.0			x
► <b>RUC-2013-26-5120-KL</b>	120	AC 50/60Hz	1910	96.0	132.0		x	x
► <b>RUC-2013-26-5230</b>	230	AC 50/60Hz	7080	184.0	253.0	x		
RUC-2013-26-5230-K	230	AC 50/60Hz	7080	184.0	253.0		x	
RUC-2013-26-5230-L	230	AC 50/60Hz	7080	184.0	253.0			x
RUC-2013-26-5230-KL	230	AC 50/60Hz	7080	184.0	253.0		x	x

### RUC DPST(2NO) AC 50/60Hz & DC coil

Part Number	Coil Voltage (V)	Coil Type	Coil resistance at 20 °C in Ω	Coil operating range		Options*		
				min. (at 20°C)	max. (at 55°C)	-	K	L
RUC-2022-26-1012	12	DC	110	9.6	13.2	x		
RUC-2022-26-1012-K	12	DC	110	9.6	13.2		x	
RUC-2022-26-1012-L	12	DC	110	9.6	13.2			x
RUC-2022-26-1012-KL	12	DC	110	9.6	13.2		x	x
RUC-2022-26-1024	24	DC	430	19.2	26.4	x		
RUC-2022-26-1024-K	24	DC	430	19.2	26.4		x	
RUC-2022-26-1024-L	24	DC	430	19.2	26.4			x
RUC-2022-26-1024-KL	24	DC	430	19.2	26.4		x	x
RUC-2022-26-1110	110	DC	9200	88.0	121.0	x		
RUC-2022-26-1110-K	110	DC	9200	88.0	121.0		x	
RUC-2022-26-1110-L	110	DC	9200	88.0	121.0			x
RUC-2022-26-1110-KL	110	DC	9200	88.0	121.0		x	x
RUC-2022-26-5120	120	AC 50/60Hz	1910	96.0	132.0	x		
RUC-2022-26-5120-K	120	AC 50/60Hz	1910	96.0	132.0		x	
RUC-2022-26-5120-L	120	AC 50/60Hz	1910	96.0	132.0			x
RUC-2022-26-5120-KL	120	AC 50/60Hz	1910	96.0	132.0		x	x
RUC-2022-26-5230	230	AC 50/60Hz	7080	184.0	253.0	x		
RUC-2022-26-5230-K	230	AC 50/60Hz	7080	184.0	253.0		x	
RUC-2022-26-5230-L	230	AC 50/60Hz	7080	184.0	253.0			x
RUC-2022-26-5230-KL	230	AC 50/60Hz	7080	184.0	253.0		x	x

### RUC 3PST(3NO) AC 50/60Hz & DC coil

Part Number	Coil Voltage (V)	Coil Type	Coil resistance at 20 °C in Ω	Coil operating range		Options*		
				min. (at 20°C)	max. (at 55°C)	-	K	L
RUC-2023-26-1012	12	DC	110	9.6	13.2	x		
RUC-2023-26-1012-K	12	DC	110	9.6	13.2		x	
RUC-2023-26-1012-L	12	DC	110	9.6	13.2			x
RUC-2023-26-1012-KL	12	DC	110	9.6	13.2		x	x
RUC-2023-26-1024	24	DC	430	19.2	26.4	x		
RUC-2023-26-1024-K	24	DC	430	19.2	26.4		x	
RUC-2023-26-1024-L	24	DC	430	19.2	26.4			x
RUC-2023-26-1024-KL	24	DC	430	19.2	26.4		x	x
RUC-2023-26-1110	110	DC	9200	88.0	121.0	x		
RUC-2023-26-1110-K	110	DC	9200	88.0	121.0		x	
RUC-2023-26-1110-L	110	DC	9200	88.0	121.0			x
RUC-2023-26-1110-KL	110	DC	9200	88.0	121.0		x	x
RUC-2023-26-5120	120	AC 50/60Hz	1910	96.0	132.0	x		
RUC-2023-26-5120-K	120	AC 50/60Hz	1910	96.0	132.0		x	
RUC-2023-26-5120-L	120	AC 50/60Hz	1910	96.0	132.0			x
RUC-2023-26-5120-KL	120	AC 50/60Hz	1910	96.0	132.0		x	x
RUC-2023-26-5230	230	AC 50/60Hz	7080	184.0	253.0	x		
RUC-2023-26-5230-K	230	AC 50/60Hz	7080	184.0	253.0		x	
RUC-2023-26-5230-L	230	AC 50/60Hz	7080	184.0	253.0			x
RUC-2023-26-5230-KL	230	AC 50/60Hz	7080	184.0	253.0		x	x

- = without additional features; K = with test button without block function; L = with light indicator (LED)

\* other options available upon request

► **BOLD** - Regular stocked items.

# R2M / RY2 / RUC

## Industrial Electromagnetic Relays

### RUC DPST(2NO) contact gap ≥ 3mm AC 50/60Hz & DC coil

Part Number	Coil Voltage (V)	Coil Type	Coil resistance at 20 °C in Ω	Coil operating range		Options*		
				min. (at 20°C)	max. (at 55°C)	-	K	L
RUC-2052-26-1012	12	DC	110	9.6	13.2	x		
RUC-2052-26-1012-K	12	DC	110	9.6	13.2		x	
RUC-2052-26-1012-L	12	DC	110	9.6	13.2			x
RUC-2052-26-1012-KL	12	DC	110	9.6	13.2		x	x
RUC-2052-26-1024	24	DC	430	19.2	26.4	x		
RUC-2052-26-1024-K	24	DC	430	19.2	26.4		x	
RUC-2052-26-1024-L	24	DC	430	19.2	26.4			x
RUC-2052-26-1024-KL	24	DC	430	19.2	26.4		x	x
RUC-2052-26-1110	110	DC	9200	88.0	121.0	x		
RUC-2052-26-1110-K	110	DC	9200	88.0	121.0		x	
RUC-2052-26-1110-L	110	DC	9200	88.0	121.0			x
RUC-2052-26-1110-KL	110	DC	9200	88.0	121.0		x	x
RUC-2052-26-5120	120	AC 50/60Hz	1910	96.0	132.0	x		
RUC-2052-26-5120-K	120	AC 50/60Hz	1910	96.0	132.0		x	
RUC-2052-26-5120-L	120	AC 50/60Hz	1910	96.0	132.0			x
RUC-2052-26-5120-KL	120	AC 50/60Hz	1910	96.0	132.0		x	x
RUC-2052-26-5230	230	AC 50/60Hz	7080	184.0	253.0	x		
RUC-2052-26-5230-K	230	AC 50/60Hz	7080	184.0	253.0		x	
RUC-2052-26-5230-L	230	AC 50/60Hz	7080	184.0	253.0			x
RUC-2052-26-5230-KL	230	AC 50/60Hz	7080	184.0	253.0		x	x

### RUC 3PST(3NO) contact gap ≥ 3mm AC 50/60Hz & DC coil

Part Number	Coil Voltage (V)	Coil Type	Coil resistance at 20 °C in Ω	Coil operating range		Options*		
				min. (at 20°C)	max. (at 55°C)	-	K	L
RUC-2053-26-1012	12	DC	110	9.6	13.2	x		
RUC-2053-26-1012-K	12	DC	110	9.6	13.2		x	
RUC-2053-26-1012-L	12	DC	110	9.6	13.2			x
RUC-2053-26-1012-KL	12	DC	110	9.6	13.2		x	x
RUC-2053-26-1024	24	DC	430	19.2	26.4	x		
RUC-2053-26-1024-K	24	DC	430	19.2	26.4		x	
RUC-2053-26-1024-L	24	DC	430	19.2	26.4			x
RUC-2053-26-1024-KL	24	DC	430	19.2	26.4		x	x
RUC-2053-26-1110	110	DC	9200	88.0	121.0	x		
RUC-2053-26-1110-K	110	DC	9200	88.0	121.0		x	
RUC-2053-26-1110-L	110	DC	9200	88.0	121.0			x
RUC-2053-26-1110-KL	110	DC	9200	88.0	121.0		x	x
RUC-2053-26-5120	120	AC 50/60Hz	1910	96.0	132.0	x		
RUC-2053-26-5120-K	120	AC 50/60Hz	1910	96.0	132.0		x	
RUC-2053-26-5120-L	120	AC 50/60Hz	1910	96.0	132.0			x
RUC-2053-26-5120-KL	120	AC 50/60Hz	1910	96.0	132.0		x	x
RUC-2053-26-5230	230	AC 50/60Hz	7080	184.0	253.0	x		
RUC-2053-26-5230-K	230	AC 50/60Hz	7080	184.0	253.0		x	
RUC-2053-26-5230-L	230	AC 50/60Hz	7080	184.0	253.0			x
RUC-2053-26-5230-KL	230	AC 50/60Hz	7080	184.0	253.0		x	x

- = without additional features

K = with test button without block function

L = with light indicator (LED)

\* Other options available upon request

# R2M / RY2 / RUC

Industrial Electromagnetic Relays - Plug-in Sockets and Accessories **Altech**

## GZ2 (for R2M)

Screw terminals  
 Max. tightening moment  
 for the terminal: 0.7 Nm  
 35 mm rail mount  
 acc. to PN-EN 60715  
 or on panel mounting  
 65.2 x 20 x 25 mm  
 Two poles  
 7 A, 250 V AC



GZ2



GZ2 1060 GZ2 1111

### CONNECTION DIAGRAM

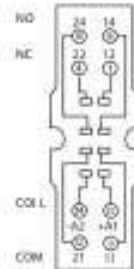

### DIMENSIONS

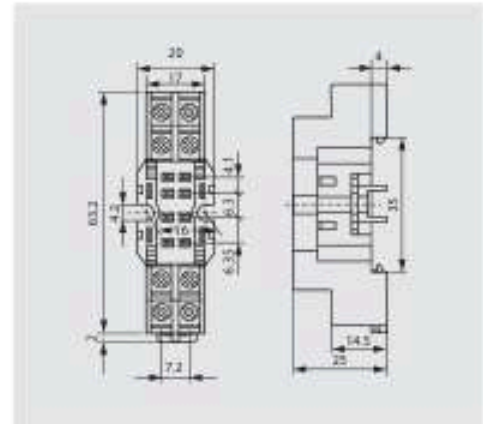

## GZY2G (for RY2)

Screw terminals  
 Max. tightening moment  
 for the terminal: 0.7 Nm  
 35 mm rail mount  
 acc. to PN-EN 60715  
 or on panel mounting  
 78.7 x 28 x 32.4 mm  
 Two poles  
 12 A, 250 V AC



GZY2G

### CONNECTION DIAGRAM

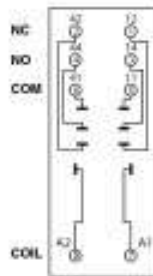

### DIMENSIONS

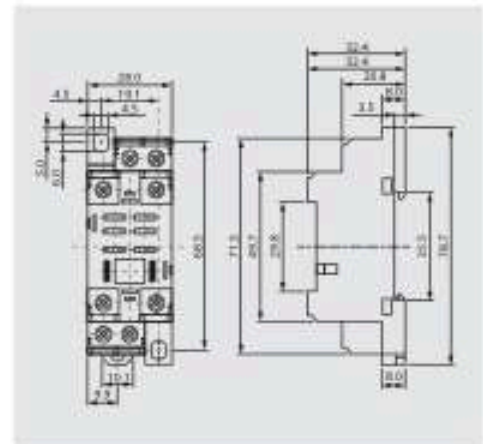

## GUC11 (for RUC)

Screw terminals  
 Max. tightening moment  
 for the terminal: 0.7 Nm  
 35 mm rail mount  
 acc. to PN-EN 60715  
 or on panel mounting  
 82 x 42.2 x 26.5 mm  
 Three poles  
 16 A, 250 V AC



GUC11



MBA

### CONNECTION DIAGRAM

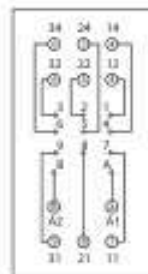

### DIMENSIONS

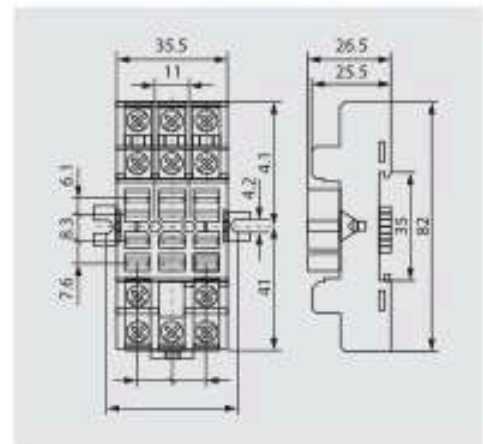

All accessories are sold separately

# R15

## Industrial Electromagnetic Relays



- Contacts AgNi
- For plug-in sockets, 35 mm rail mount or on panel mounting.
- Cadmium-free contacts-R15 DPDT, R15 3PDT, R15 4PDT relays
- WT (mechanical indicator and lockable front test button) - standard features of R15 DPDT, R15 3PDT relays in cover, for plug-in sockets.
- Relays may be provided with the test buttons (no latching) and plugs (see page 115).
- AUCOTEAM, GmbH Berlin - railway standards.



### Contact Data

Number and type of contacts		DPDT	3PDT	4PDT
Contact material		AgNi	AgNi	AgCdO
Rated / max. switching voltage AC		250 V / 440 V	250 V / 440 V	250 V / 440 V
Min. switching voltage		10 V	10 V	10 V
Rated load (capacity)	AC1	10 A / 250 V AC; 10 A / 277 V AC (UL 508)	10 A / 250 V AC; 10 A / 277 V AC (UL 508)	10 A / 250 V AC; 10 A / 277 V AC (UL 508)
	AC15	3 A / 120 V; 1.5 A / 240 V (B300)	3 A / 120 V; 1.5 A / 240 V (B300)	3 A / 120 V; 1.5 A / 240 V (B300)
	AC3	370 W (single-phase motor); 1/2 HP / 240 V AC (UL 508)	370 W (single-phase motor); 1/2 HP / 240 V AC (UL 508)	370 W (single-phase motor); 1/2 HP / 240 V AC (UL 508)
	DC1	10 A / 24 V DC (see Fig. 3)	10 A / 24 V DC (see Fig. 3)	10 A / 24 V DC (see Fig. 3)
	DC13	0.22 A / 120 V; 0.1 A / 250 V (R300)	0.22 A / 120 V; 0.1 A / 250 V (R300)	0.22 A / 120 V; 0.1 A / 250 V (R300)
Min. switching current		5 mA	5 mA	10 mA
Max. inrush current		20 A	20 A	20 A
Rated current		10A	10A	10A
Max. breaking capacity AC1		2500 VA	2500 VA	2500 VA
Min. breaking capacity		0.3 W	0.3 W	0.5 W
Contact resistance		≤ 100 mΩ	≤ 100 mΩ	≤ 100 mΩ
Max. operating frequency				
	• at rated load	1200 cycles/hour	1200 cycles/hour	1200 cycles/hour
	• no load	12000 cycles/hour	12000 cycles/hour	12000 cycles/hour

### Coil Data

Rated voltage	50/60 Hz AC	6 ... 240 V	6 ... 240 V	6 ... 240 V
	DC	6 ... 220 V	6 ... 220 V	6 ... 220 V
Must release voltage		AC: ≥ 0.15 U <sub>n</sub> ; DC: ≥ 0.1 U <sub>n</sub>	AC: ≥ 0.15 U <sub>n</sub> ; DC: ≥ 0.1 U <sub>n</sub>	AC: ≥ 0.15 U <sub>n</sub> ; DC: ≥ 0.1 U <sub>n</sub>
Operating range of supply voltage		see page 68	see page 68	see page 68
Rated power consumption		AC: 2.8 VA 50 Hz; 2.5 VA 60 Hz; DC: 1.5 W	AC: 2.8 VA 50 Hz; 2.5 VA 60 Hz; DC: 1.5 W	AC: 2.8 VA 50 Hz; 2.5 VA 60 Hz; DC: 1.5 W

### Insulation

Insulation rated voltage		250 V AC	250 V AC	250 V AC
Rated surge voltage		2500 V 1.2 / 50 μs	2500 V 1.2 / 50 μs	2500 V 1.2 / 50 μs
Overvoltage category		III	II	II
Insulation pollution degree		3	3	3
Dielectric strength				
	• between coil and contacts	2500 V AC type of insulation: basic	2500 V AC type of insulation: basic	2500 V AC type of insulation: basic
	• contact clearance	1500 V AC type of clearance: micro-disco.	1500 V AC type of clearance: micro-disco.	1500 V AC type of clearance: micro-disco.
	• pole - pole	2000 V AC type of insulation: basic	2000 V AC type of insulation: basic	2000 V AC type of insulation: basic
Contact - coil distance				
	• clearance	≥ 3 mm	≥ 3 mm	≥ 3 mm
	• creepage	≥ 4.2 mm	≥ 4.2 mm	≥ 3.2 mm

### General Data

Operating / release time (typical)		AC: 12 ms / 10 ms; DC: 18 ms / 7 ms	AC: 12 ms / 10 ms; DC: 18 ms / 7 ms	AC: 12 ms / 10 ms; DC: 18 ms / 7 ms
Electrical life				
	• resistive AC1	> 2 x 10 <sup>7</sup> ; 10 A, 250 V AC	> 2 x 10 <sup>7</sup> ; 10 A, 250 V AC	> 2 x 10 <sup>7</sup> ; 10 A, 250 V AC
	• cos	see Fig. 2	see Fig. 2	see Fig. 2
Mechanical life (cycles)		> 2 x 10 <sup>7</sup>	> 2 x 10 <sup>7</sup>	> 2 x 10 <sup>7</sup>
Dimensions (L x W x H)		35 x 35 x 54.4 mm	35 x 35 x 54.4 mm	35 x 42.5 x 54.5 mm
Weight		83 g	83 g	95 g
Ambient temperature				
	• storage	-40...+85 °C	-40...+85 °C	-40...+85 °C
	• operating	AC: -40...+55 °C DC: -40...+70 °C	AC: -40...+55 °C DC: -40...+70 °C	AC: -40...+55 °C DC: -40...+70 °C
Cover protection category		IP 40 PN-EN 60529	IP 40 PN-EN 60529	IP 40 PN-EN 60529
Environmental protection		RTI PN-EN 116000-3	RTI PN-EN 116000-3	RTI PN-EN 116000-3
Shock resistance		10 g	10 g	10 g
Vibration resistance		5 g 10...150 Hz	5 g 10...150 Hz	5 g 10...150 Hz
Solder bath temperature		max. 270 °C	max. 270 °C	max. 270 °C
Soldering time		max. 5 s	max. 5 s	max. 5 s

### DPDT

#### CONNECTION DIAGRAM

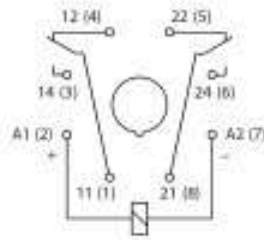

#### DIMENSIONS

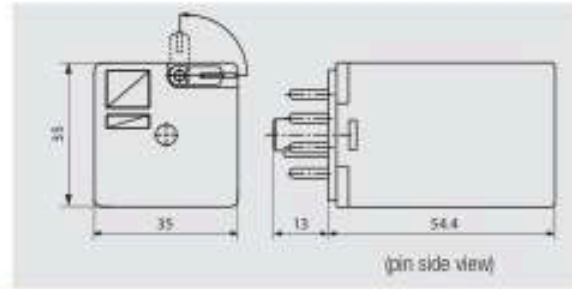

### 3PDT

#### CONNECTION DIAGRAM

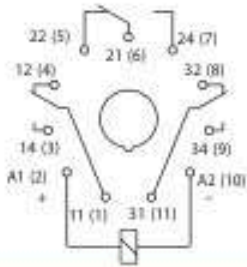

#### DIMENSIONS

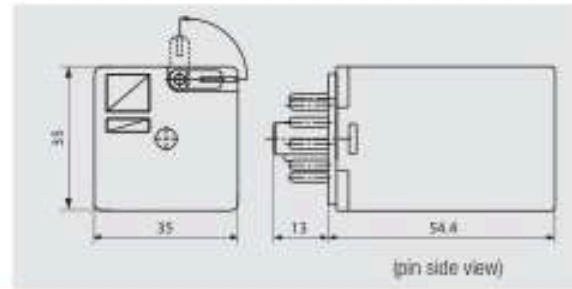

### 4PDT

#### CONNECTION DIAGRAM

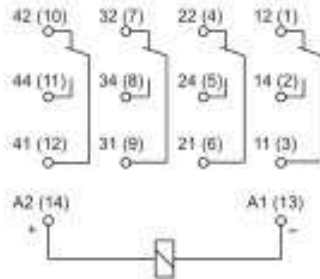

#### DIMENSIONS

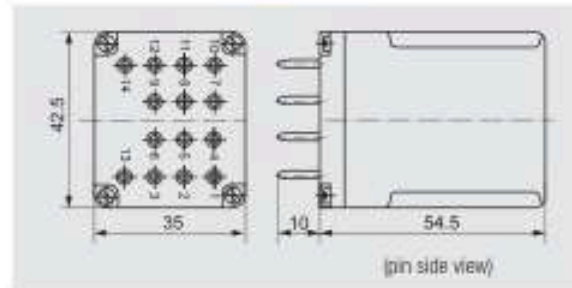

### LOAD CHARTS

Electrical life at AC resistive load. Switching frequency: 1200 cycles/hour Fig. 1

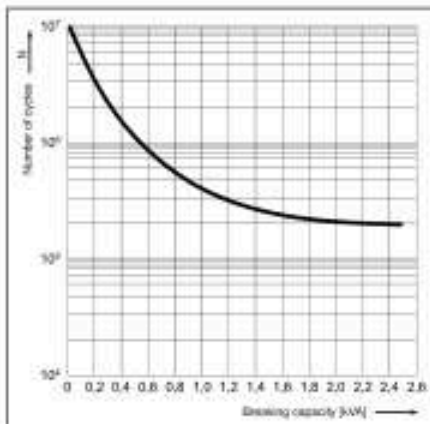

Electrical life reduction factor at AC inductive load Fig. 2

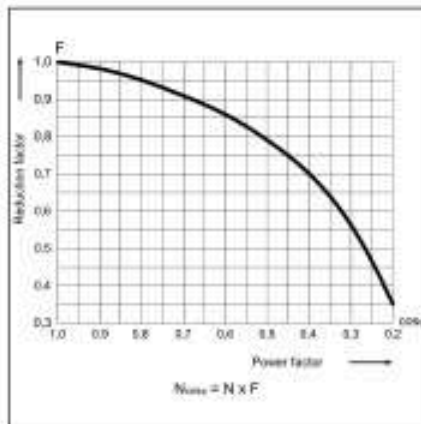

Max. DC breaking capacity A - resistive load DC1 B - inductive load L/R = 40 ms Fig. 3

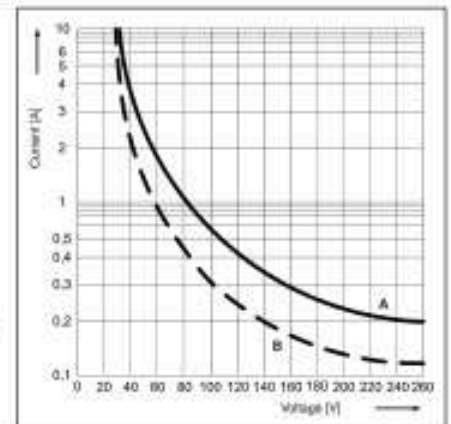

# R15

## Industrial Electromagnetic Relays

### R15 DPDT AC 50/60Hz & DC coil

Part Number	Coil Voltage (V)	Coil Type	Coil resistance at 20 °C in Ω	Coil operating range		Options*		
				min. (at 20°C)	max. (at 55°C)	-	WT	WTL
▶ <b>R15-2012-23-1012</b>	12	DC	110	9.6	13.2	x		
R15-2012-23-1012-WT	12	DC	110	9.6	13.2		x	
R15-2012-23-1012-WTL	12	DC	110	9.6	13.2			x
▶ <b>R15-2012-23-1024</b>	24	DC	430	19.2	26.4	x		
R15-2012-23-1024-WT	24	DC	430	19.2	26.4		x	
▶ <b>R15-2012-23-1024-WTL</b>	24	DC	430	19.2	26.4			x
R15-2012-23-1110	110	DC	9200	88.0	121.0	x		
R15-2012-23-1110-WT	110	DC	9200	88.0	121.0		x	
R15-2012-23-1110-WTL	110	DC	9200	88.0	121.0			x
▶ <b>R15-2012-23-5024</b>	24	AC 50/60Hz	75	19.2	26.4	x		
R15-2012-23-5024-WT	24	AC 50/60Hz	75	19.2	26.4		x	
R15-2012-23-5024-WTL	24	AC 50/60Hz	75	19.2	26.4			x
▶ <b>R15-2012-23-5120</b>	120	AC 50/60Hz	1910	96.0	132.0	x		
R15-2012-23-5120-WT	120	AC 50/60Hz	1910	96.0	132.0		x	
▶ <b>R15-2012-23-5120-WTL</b>	120	AC 50/60Hz	1910	96.0	132.0			x
▶ <b>R15-2012-23-5230</b>	230	AC 50/60Hz	7080	184.0	253.0	x		
R15-2012-23-5230-WT	230	AC 50/60Hz	7080	184.0	253.0		x	
R15-2012-23-5230-WTL	230	AC 50/60Hz	7080	184.0	253.0			x

### R15 3PDT AC 50/60Hz & DC coil

Part Number	Coil Voltage (V)	Coil Type	Coil resistance at 20 °C in Ω	Coil operating range		Options*		
				min. (at 20°C)	max. (at 55°C)	-	WT	WTL
▶ <b>R15-2013-23-1012</b>	12	DC	110	9.6	13.2	x		
R15-2013-23-1012-WT	12	DC	110	9.6	13.2		x	
R15-2013-23-1012-WTL	12	DC	110	9.6	13.2			x
▶ <b>R15-2013-23-1024</b>	24	DC	430	19.2	26.4	x		
R15-2013-23-1024-WT	24	DC	430	19.2	26.4		x	
▶ <b>R15-2013-23-1024-WTL</b>	24	DC	430	19.2	26.4			x
R15-2013-23-1110	110	DC	9200	88.0	121.0	x		
R15-2013-23-1110-WT	110	DC	9200	88.0	121.0		x	
R15-2013-23-1110-WTL	110	DC	9200	88.0	121.0			x
▶ <b>R15-2013-23-5024</b>	24	AC 50/60Hz	75	19.2	26.4	x		
R15-2013-23-5024-WT	24	AC 50/60Hz	75	19.2	26.4		x	
R15-2013-23-5024-WTL	24	AC 50/60Hz	75	19.2	26.4			x
▶ <b>R15-2013-23-5120</b>	120	AC 50/60Hz	1910	96.0	132.0	x		
R15-2013-23-5120-WT	120	AC 50/60Hz	1910	96.0	132.0		x	
▶ <b>R15-2013-23-5120-WTL</b>	120	AC 50/60Hz	1910	96.0	132.0			x
▶ <b>R15-2013-23-5230</b>	230	AC 50/60Hz	7080	184.0	253.0	x		
R15-2013-23-5230-WT	230	AC 50/60Hz	7080	184.0	253.0		x	
R15-2013-23-5230-WTL	230	AC 50/60Hz	7080	184.0	253.0			x

### R15 4PDT AC 50/60Hz & DC coil

Part Number	Coil Voltage (V)	Coil Type	Coil resistance at 20 °C in Ω	Coil operating range		Options*			
				min. (at 20°C)	max. (at 55°C)	-	K	WT	WTL
R15-1014-23-1012	12	DC	110	9.6	13.2	x			
R15-1014-23-1012-K	12	DC	110	9.6	13.2		x		
R15-1014-23-1012-L	12	DC	110	9.6	13.2			x	
R15-1014-23-1012-D	12	DC	110	9.6	13.2				x
R15-1014-23-1024	24	DC	430	19.2	26.4	x			
R15-1014-23-1024-K	24	DC	430	19.2	26.4		x		
▶ <b>R15-1014-23-1024-L</b>	24	DC	430	19.2	26.4			x	
R15-1014-23-1024-D	24	DC	430	19.2	26.4				x
R15-1014-23-1110	110	DC	9200	88.0	121.0	x			
R15-1014-23-1110-K	110	DC	9200	88.0	121.0		x		
R15-1014-23-1110-L	110	DC	9200	88.0	121.0			x	
R15-1014-23-1110-D	110	DC	9200	88.0	121.0				x
R15-1014-23-3024	24	AC 50Hz	72	19.2	26.4	x			
R15-1014-23-3024-K	24	AC 50Hz	72	19.2	26.4		x		
R15-1014-23-3024-L	24	AC 50Hz	72	19.2	26.4			x	
R15-1014-23-3024-D	24	AC 50Hz	72	19.2	26.4				x
R15-1014-23-3120	120	AC 50Hz	2300	96.0	132.0	x			
R15-1014-23-3120-K	120	AC 50Hz	2300	96.0	132.0		x		
R15-1014-23-3120-L	120	AC 50Hz	2300	96.0	132.0			x	
R15-1014-23-3120-D	120	AC 50Hz	2300	96.0	132.0				x
R15-1014-23-3230	230	AC 50Hz	7900	184.0	253.0	x			
R15-1014-23-3230-K	230	AC 50Hz	7900	184.0	253.0		x		
R15-1014-23-3230-L	230	AC 50Hz	7900	184.0	253.0			x	
R15-1014-23-3230-D	230	AC 50Hz	7900	184.0	253.0				x
R15-1014-23-6120	120	AC 60Hz	2000	96.0	132.0	x			
R15-1014-23-6120-K	120	AC 60Hz	2000	96.0	132.0		x		
▶ <b>R15-1014-23-6120-L</b>	120	AC 60Hz	2000	96.0	132.0			x	
R15-1014-23-6120-D	120	AC 60Hz	2000	96.0	132.0				x
R15-1014-23-6230	230	AC 60Hz	7000	184.0	253.0	x			
R15-1014-23-6230-K	230	AC 60Hz	7000	184.0	253.0		x		
R15-1014-23-6230-L	230	AC 60Hz	7000	184.0	253.0			x	
R15-1014-23-6230-D	230	AC 60Hz	7000	184.0	253.0				x

WT = with mechanical indicator + lockable front test button; WTL = with mechanical indicator + lockable front test button + light indicator (LED)  
K = with test button without block function; L = with light indicator (LED); D = with surge suppression element (diode); other options available upon request

▶ **BOLD** - Regular stocked items.

# R15

## Industrial Electromagnetic Relays - Plug-in Sockets and Accessories

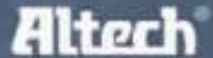

### GZP8 for R15 DPDT

Screw terminals  
 Max. tightening moment  
 for the terminal: 0.5 Nm  
 35 mm rail mount  
 acc. to PN-EN 60715  
 or on panel mounting  
 73 x 38.2 x 27.2 mm Two poles  
 12 A, 300 V AC



GZP8

#### CONNECTION DIAGRAM

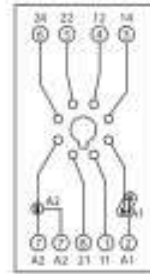

#### DIMENSIONS

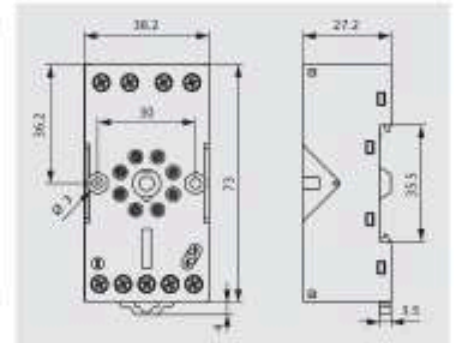

Time module COM3T



GZP-0035



GZP-0054

### PZ8 for R15 DPDT

Screw terminals  
 Max. tightening moment  
 for the terminal: : 0.7 Nm  
 35 mm rail mount  
 acc. to PN-EN 60715  
 or on panel mounting  
 68.2 x 38 x 24.2 mm  
 Two poles  
 10 A, 250 V AC



PZ8

#### CONNECTION DIAGRAM

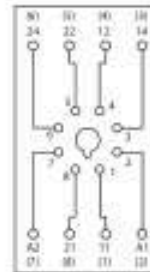

#### DIMENSIONS

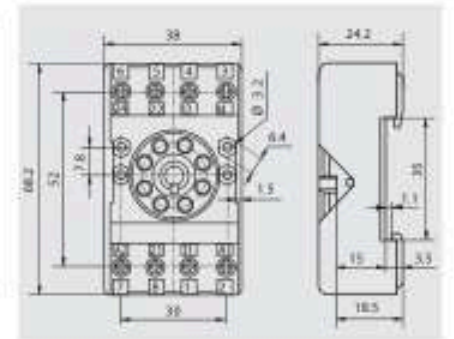

PZ11 0031

### GZP11 for R15 3PDT

Screw terminals  
 Max. tightening moment  
 for the terminal: : 0.5 Nm  
 35 mm rail mount  
 acc. to PN-EN 60715  
 or on panel mounting  
 73 x 38.2 x 27.2 mm  
 Three poles  
 12 A, 300 V AC



GZP11

#### CONNECTION DIAGRAM

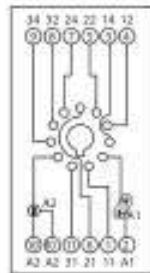

#### DIMENSIONS

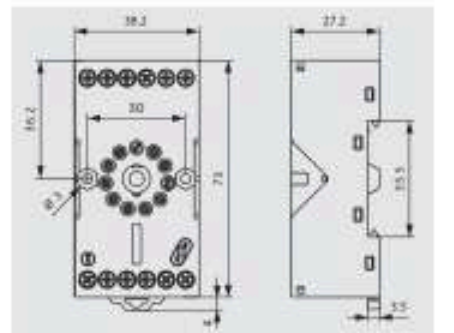

Time module COM3T



GZP-0035



GZP-0054

All accessories are sold separately

# R15

## Industrial Electromagnetic Relays - Plug-in Sockets and Accessories

### PZ11 for R15 3PDT

Screw terminals  
 Max. tightening moment  
 for the terminal: : 0.7 Nm  
 35 mm rail mount  
 acc. to PN-EN 60715  
 or on panel mounting  
 68.2 x 38 x 24.2 mm  
 Three poles  
 10 A, 250 V AC



PZ11



PZ11 0031

### CONNECTION DIAGRAM

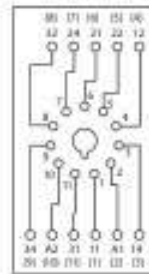

### DIMENSIONS

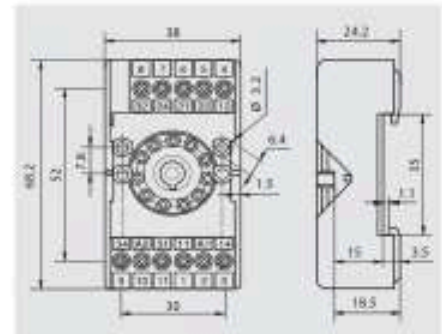

### GZ14U for R15 4PDT

Screw terminals  
 Max. tightening moment  
 for the terminal: : 0.7 Nm  
 35 mm rail mount  
 acc. to PN-EN 60715  
 96.8 x 46.2 x 33.3 mm  
 Four poles  
 10 A, 250 V AC



GZ14ZU



GZ14 0737

### CONNECTION DIAGRAM

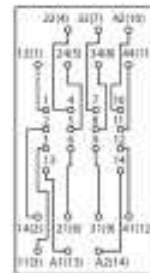

### DIMENSIONS

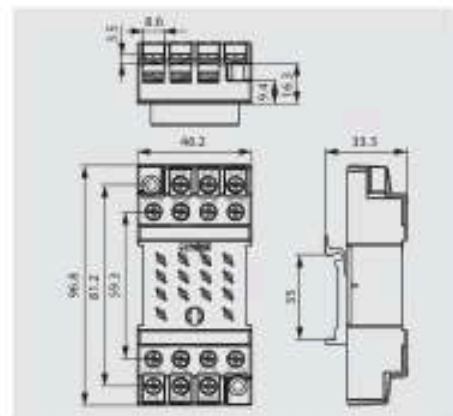

See Relay Socket Combinations on pages 104-109



All accessories are sold separately

# Altech Custom Assemblies



**Altech provides quick turnaround  
and competitive prices on assemblies.**  
For complete assemblies contact Altech.

# RM40 and RM50

## Miniature Electromagnetic Relays

### RM40



- Very small dimensions
- High switching capacity up to 5 A or 8 A
- Cover with enhanced sealing protects the relay in course of soldering and cleaning
- Applications: for household equipment, office machines, control devices, alarm systems, in industrial control, industrial controllers
- Recognitions, certifications, directives: RoHS



E105728

### RM50



- Small dimensions
- Switching current up to 10 A / 15 A
- The plastics applied provide for the operation of the relays at high temperature and in chemical environment
- Sealed, for soldering
- Applications: for household equipment, office machines, audio equipment, coffee machines, control devices, etc.
- Recognitions, certifications, directives: RoHS



E105728

### RM40

### RM50

#### Contact Data

No. and type of contacts		SPDT	SPST (1NO)	SPDT, SPST (1NO)
Contact material		AgNi	AgSnO <sub>2</sub>	AgSnO <sub>2</sub>
Rated / max. switching voltage		250 V / 380 V	250 V / 440 V	240 V / 277 V
Min. switching voltage		5 V AgNi	5 V AgSnO <sub>2</sub>	5 V
Rated load	AC1	5 A / 250 V AC	8 A / 250 V AC	10 A / 240 V AC
	DC1	5 A / 30 V DC	8 A / 30 V DC	15 A / 24 V DC
Min. switching current		10 mA AgNi	10 mA AgSnO <sub>2</sub>	15 mA
Rated current		5 A	8 A	12 A
Max. breaking capacity		1250 VA	2000 VA	3000 VA
Min. breaking capacity		50 mW AgNi	50 mW AgSnO <sub>2</sub>	0.75 W
Contact resistance		≤ 100 mΩ	≤ 100 mΩ	≤ 100 mΩ

#### Coil Data

Rated voltage	DC	3 ... 48 V	3 ... 48 V	3 ... 48 V
Must release voltage		DC: ≥ 0.05 U <sub>N</sub>	DC: ≥ 0.05 U <sub>N</sub>	DC: ≥ 0.05 U <sub>N</sub>
Operating range of supply voltage		see page 75	see page 75	see page 75
Rated power consumption	DC	0.20 W	0.20 W	0.36 W 3 ... 24 V; 0.45 W 48 V

#### Insulation

Dielectric strength		4000 V AC type of insulation: reinforced	4000 V AC type of insulation: reinforced	1000 V AC type of insulation: basic
• between coil and contacts		1000 V AC type of clearance: micro-disconnection	1000 V AC type of clearance: micro-disconnection	500 V AC type of clearance: micro-disconnection
• contact clearance				
Contact - coil distance				
• clearance		≥ 5 mm	≥ 5 mm	≥ 1.9 mm
• creepage		≥ 5 mm	≥ 5 mm	≥ 1.9 mm

#### General Data

Operating / release time (typical values)		8 ms / 4 ms	8 ms / 4 ms	10 ms / 5 ms
Electrical life (number of cycles)				
• resistive AC1 360 cycles/hour		> 10 <sup>7</sup> ; 5 A, 250 V AC	> 10 <sup>7</sup> ; 8 A, 250 V AC	-
• resistive AC1 1 200 cycles/hour		-	-	> 10 <sup>7</sup> ; 7 A, 250 V AC
• resistive AC1 1 200 cycles/hour		-	-	> 3 x 10 <sup>6</sup> ; 12 A, 250 V AC
• resistive DC1 1 200 cycles/hour		-	-	> 5 x 10 <sup>6</sup> ; 15 A, 24 V DC
• resistive DC1 1 800 cycles/hour		> 10 <sup>7</sup> ; 5 A, 30 V DC	> 10 <sup>7</sup> ; 8 A, 30 V DC	-
Mechanical life 18 000 cycles/hour		> 10 <sup>7</sup>	> 10 <sup>7</sup>	> 10 <sup>7</sup>
Dimensions (L x W x H)		20 x 10 x 10.5 mm	20 x 10 x 10.5 mm	19 x 15.4 x 15.5 mm
Weight		6 g	6 g	11 g
Ambient temperature				
• operating		-40...+85 °C	-40...+85 °C	-30...+55 °C
Cover protection category		IP 64 PN-EN 60529	IP 64 PN-EN 60529	IP 64 PN-EN 60529
Shock resistance		10 g	10 g	10 g
Vibration resistance		1.5 mm DA (constant amplitude) 10...55 Hz	1.5 mm DA (constant amplitude) 10...55 Hz	1.5 mm DA (constant amplitude) 10...55 Hz
Solder bath temperature		max. 235 °C	max. 235 °C	max. 235 °C
Soldering time		max. 3.5 s	max. 3.5 s	max. 3.5 s

# RM40 and RM50

## Miniature Electromagnetic Relays

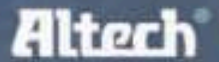

RM40



### CONNECTION DIAGRAM

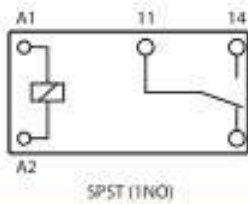
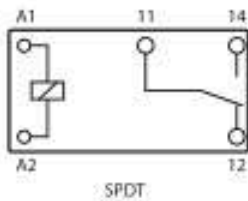

### DIMENSIONS

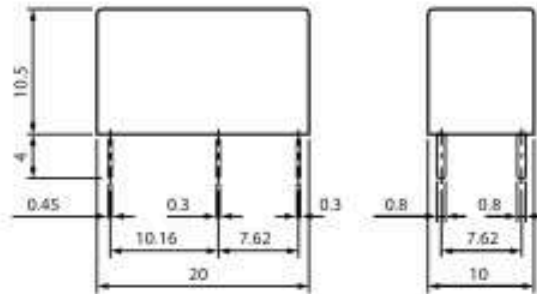

### LOAD CHARTS

Coil temperature rise

Fig. 1

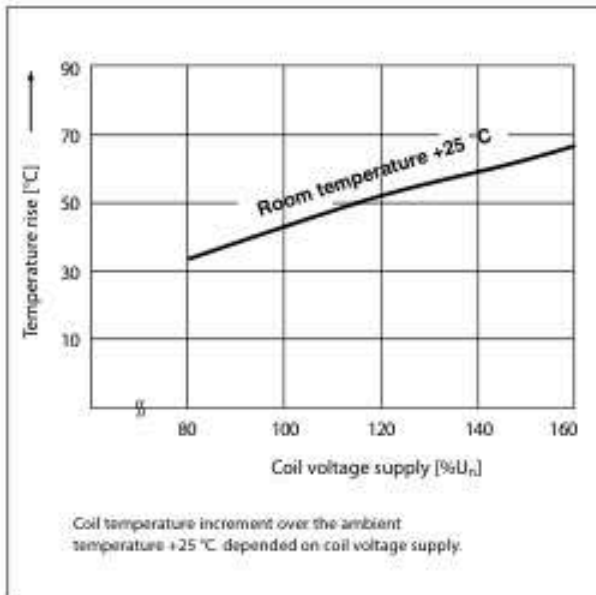

Release time

Fig. 2

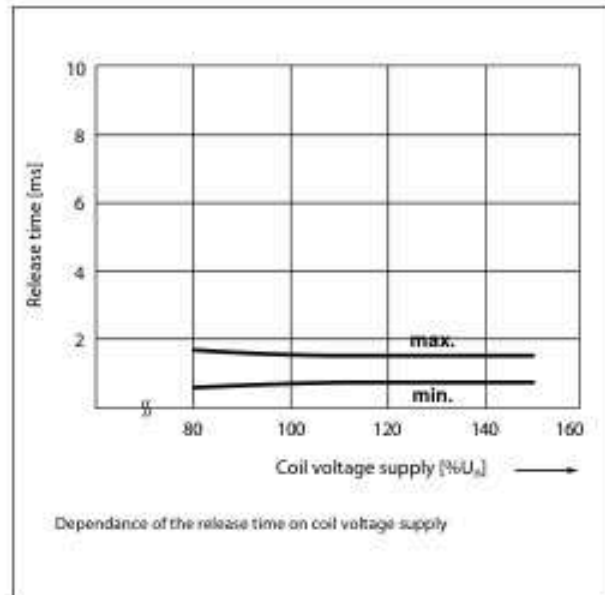

# RM40 and RM50

## Miniature Electromagnetic Relays

RM50



### CONNECTION DIAGRAM

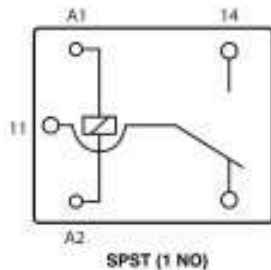
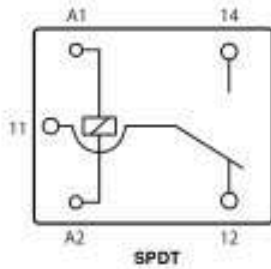

### DIMENSIONS

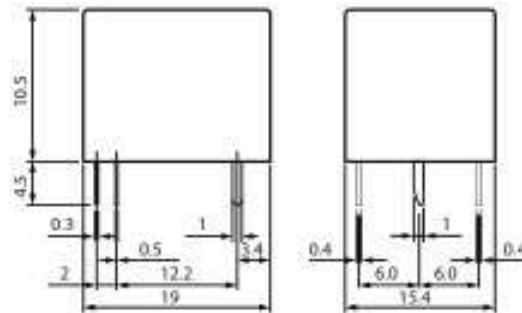

### LOAD CHARTS

**Coil temperature rise**

Fig. 1

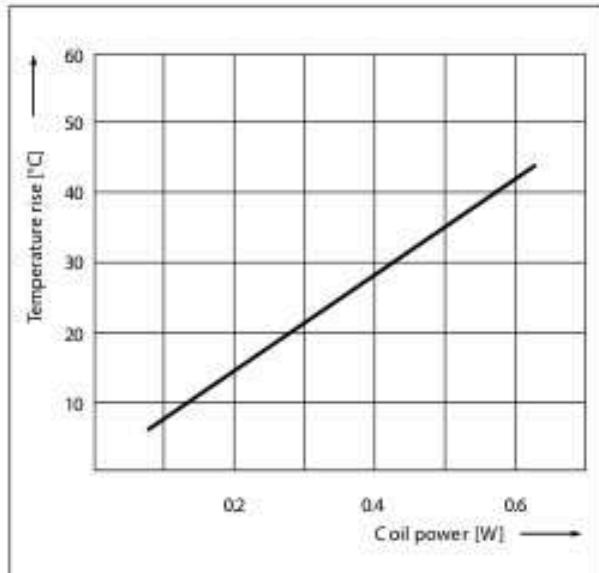

**Operating / release time**

Fig. 2

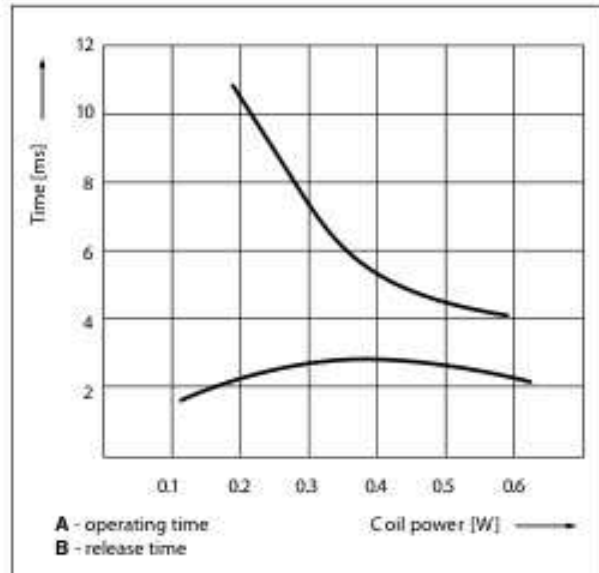

# RM40 and RM50

## Miniature Electromagnetic Relays

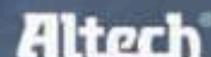

### R40 SPDT DC coil

Part Number	Coil Voltage (V)	Coil Type	Coil resistance at 20 °C in $\Omega$	Coil operating range	
				min. (at 20°C)	max. (at 55°C)
RM40-2011-85-1003	3	DC	45	2.25	4.50
RM40-2011-85-1005	5	DC	125	3.75	7.50
RM40-2011-85-1006	6	DC	180	4.50	9.00
RM40-2011-85-1009	9	DC	405	6.75	13.50
RM40-2011-85-1012	12	DC	720	9.00	18.00
RM40-2011-85-1024	24	DC	2880	18.00	36.00
RM40-2011-85-1048	48	DC	11520	36.00	72.00

### R40 SPST(1NO) DC coil

Part Number	Coil Voltage (V)	Coil Type	Coil resistance at 20 °C in $\Omega$	Coil operating range	
				min. (at 20°C)	max. (at 55°C)
RM40-3021-85-1003	3	DC	45	2.25	4.50
RM40-3021-85-1005	5	DC	125	3.75	7.50
RM40-3021-85-1006	6	DC	180	4.50	9.00
RM40-3021-85-1009	9	DC	405	6.75	13.50
RM40-3021-85-1012	12	DC	720	9.00	18.00
RM40-3021-85-1024	24	DC	2880	18.00	36.00
RM40-3021-85-1048	48	DC	11520	36.00	72.00

### R50 SPDT DC coil

Part Number	Coil Voltage (V)	Coil Type	Coil resistance at 20 °C in $\Omega$	Coil operating range	
				min. (at 20°C)	max. (at 55°C)
RM50-3011-85-1003	3	DC	25	2.25	3.90
RM50-3011-85-1005	5	DC	70	3.75	6.50
RM50-3011-85-1006	6	DC	100	4.50	7.80
RM50-3011-85-1009	9	DC	225	6.75	11.70
RM50-3011-85-1012	12	DC	400	9.00	15.60
RM50-3011-85-1018	18	DC	900	13.50	23.40
RM50-3011-85-1024	24	DC	1600	18.00	31.20
RM50-3011-85-1048	48	DC	6400	38.40	62.40

### R50 SPST(1NO) DC coil

Part Number	Coil Voltage (V)	Coil Type	Coil resistance at 20 °C in $\Omega$	Coil operating range	
				min. (at 20°C)	max. (at 55°C)
RM50-3021-85-1003	3	DC	25	2.25	3.90
RM50-3021-85-1005	5	DC	70	3.75	6.50
RM50-3021-85-1006	6	DC	100	4.50	7.80
RM50-3021-85-1009	9	DC	225	6.75	11.70
RM50-3021-85-1012	12	DC	400	9.00	15.60
RM50-3021-85-1018	18	DC	900	13.50	23.40
RM50-3021-85-1024	24	DC	1600	18.00	31.20
RM50-3021-85-1048	48	DC	6400	38.40	62.40

# RM84 / RM85 / RM87

## Miniature Electromagnetic Relays



- Miniature dimensions
- 5000 V / 10 mm reinforced insulation
- Available special versions with the increased dielectric strength of the contact clearance
- IP67 flux proof, water proof and sealed cover protection (For P4) unsealed, contact Attech
- Cadmium - free contacts
- For PCB and plug-in sockets

Contact Data		RM84	RM85	RM87
<b>No. and type of contacts</b>		<b>DPDT, DPST (2NO)</b>	<b>SPDT, SPST (1NO)</b>	<b>SPDT, SPST (1NO)</b>
Contact material		AgNi	AgNi	AgNi
Rated / max. switching voltage AC		250 V / 440 V	250 V / 440 V	250 V / 440 V
Min. switching voltage		5 V	5 V	5 V
Rated load (capacity)		8 A / 250 V AC	16 A / 250 V AC	12 A / 250 V AC
AC1		3 A / 120 V, 1.5 A / 240 V (B300)	3 A / 120 V, 1.5 A / 240 V (B300)	3 A / 120 V, 1.5 A / 240 V (B300)
AC15		550 W (single-phase motor)	750 W (single-phase motor)	750 W (single-phase motor)
AC3		8 A / 24 V DC (see Fig. 3.1)	16 A / 24 V DC (see Fig. 3.2)	12 A / 24 V DC (see Fig. 3.3)
DC1		0.22 A / 120 V, 0.1 A / 250 V (R300)	0.22 A / 120 V, 0.1 A / 250 V (R300)	0.22 A / 120 V, 0.1 A / 250 V (R300)
DC13				
Min. switching current		5 mA	5 mA	5 mA
Max. inrush current		12 A	24 A	18 A
<b>Rated current</b>		<b>8 A</b>	<b>16 A</b>	<b>12 A</b>
Max. breaking capacity AC1		2 000 VA	4 000 VA	3 000 VA
Min. breaking capacity		0.3 W	0.3 W	0.3 W
Contact resistance		≤ 100 mΩ	≤ 100 mΩ	≤ 100 mΩ
Max. operating frequency				
• at rated load AC1		600 cycles/hour	600 cycles/hour	600 cycles/hour
• no load		72000 cycles/hour	72000 cycles/hour	72000 cycles/hour
<b>Coil Data</b>				
Rated voltage 50/60 Hz AC		12 ... 240 V	12 ... 240 V	12 ... 240 V
DC		3 ... 110 V	3 ... 110 V	3 ... 110 V
Must release voltage		AC: ≥ 0.15 U <sub>n</sub> ; DC: ≥ 0.1 U <sub>n</sub>	AC: ≥ 0.15 U <sub>n</sub> ; DC: ≥ 0.1 U <sub>n</sub>	AC: ≥ 0.15 U <sub>n</sub> ; DC: ≥ 0.1 U <sub>n</sub>
Operating range of supply voltage		see page 80 and Fig. 4.1, 5.1	see page 80 and Fig. 4.2, 5.2	see page 80 and Fig. 4.3, 5.3
Rated power consumption AC		0.75 VA	0.75 VA	0.75 VA
DC		0.4 ... 0.48 W	0.4 ... 0.48 W	0.4 ... 0.48 W
<b>Insulation</b>				
Insulation rated voltage		400 V AC	400 V AC	400 V AC
Rated surge voltage		4000 V 12 / 50 μs	4000 V 12 / 50 μs	4000 V 12 / 50 μs
Overvoltage category		II	II	II
Insulation pollution degree		3	3	3
Dielectric strength				
• between coil and contacts		5000 V AC type of insulation: reinforced	5000 V AC type of insulation: reinforced	5000 V AC type of insulation: reinforced
• contact clearance		1000 V AC type of clearance: micro-disconnection	1000 V AC type of clearance: micro-disconnection	1000 V AC type of clearance: micro-disconnection
		2000 V AC contacts DPST (2NO)	2000 V AC contacts DPST (2NO)	2000 V AC contacts SPST (1NO)
		type of clearance: full-disconnect	type of clearance: full-disconnect	type of clearance: full-disconnect
• pole - pole		2500 V AC type of insulation: basic	-	-
Contact - coil distance				
• clearance		≥ 10 mm	≥ 10 mm	≥ 10 mm
• creepage		≥ 10 mm	≥ 10 mm	≥ 10 mm
<b>General data</b>				
Operating / release time (typical values)		7 ms / 3 ms	7 ms / 3 ms	7 ms / 3 ms
Electrical life				
• resistive AC1		> 10 <sup>7</sup> ; 8 A, 250 V AC	> 0.7 x 10 <sup>7</sup> ; 16 A, 250 V AC	> 10 <sup>7</sup> ; 12 A, 250 V AC
• creep		see Fig. 2.1	see Fig. 2.2	see Fig. 2.3
• DC LR=40 ms		> 10 <sup>7</sup> ; 0.15 A, 220 V DC	> 10 <sup>7</sup> ; 0.15 A, 220 V DC	> 10 <sup>7</sup> ; 0.15 A, 220 V DC
Mechanical life (cycles)		> 3 x 10 <sup>7</sup>	> 3 x 10 <sup>7</sup>	> 3 x 10 <sup>7</sup>
Dimensions (L x W x H)		29 x 12.7 x 15.7 mm	29 x 12.7 x 15.7 mm	29 x 12.7 x 15.7 mm
Weight		14 g	14 g	14 g
Ambient temperature				
• storage		-40...+85 °C	40...+85 °C	40...+85 °C
• operating		AC: -40...+70 °C DC: -40...+85 °C	AC: -40...+70 °C DC: -40...+85 °C	AC: -40...+70 °C DC: -40...+85 °C
Cover protection category		IP 67 PN-EN 60529	IP 67 PN-EN 60529	IP 67 PN-EN 60529
Environmental protection		RTR PN-EN 116000-3	RTR PN-EN 116000-3	RTR PN-EN 116000-3
Shock resistance (NONC)		20 g	30 g	30 g
Vibration resistance		10 g / 5 g, 10...150 Hz	10 g, 10...150 Hz	10 g, 10...150 Hz
Solder bath temperature		max. 270 °C	max. 270 °C	max. 270 °C
Soldering time		max. 5 s	max. 5 s	max. 5 s

# RM84 / RM85 / RM87

## Miniature Electromagnetic Relays

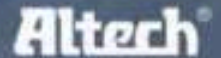

**RM84**

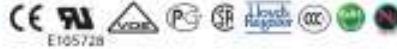

### CONNECTION DIAGRAM

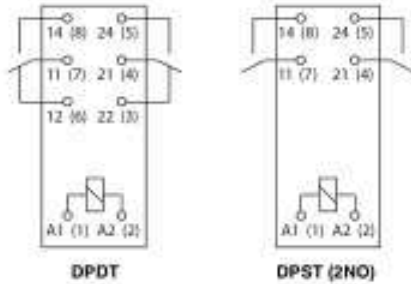

Terminal (pin)	A1(1), A2(2)	22(3), 21(4), 24(5), 12(6), 11(7), 14(8)
(mm)	Ø 0.8	0.5 x 0.9
Drilling hole:		
- for relays	Ø 1.3 ± 0.1 mm	
- for sockets	Ø 1.5 ± 0.1 mm	

### DIMENSIONS

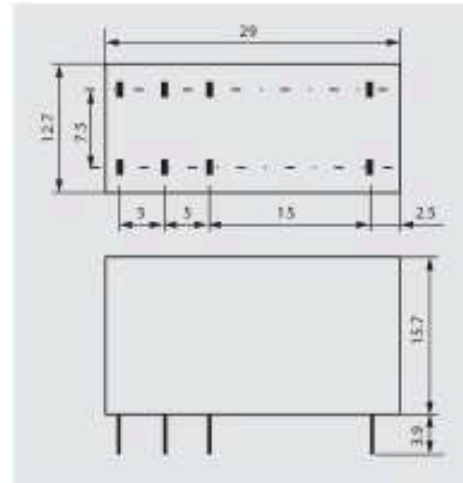

### LOAD CHARTS

**Electrical life at AC resistive load.** Switching frequency: 600 cycles/hour **Fig. 1.1**

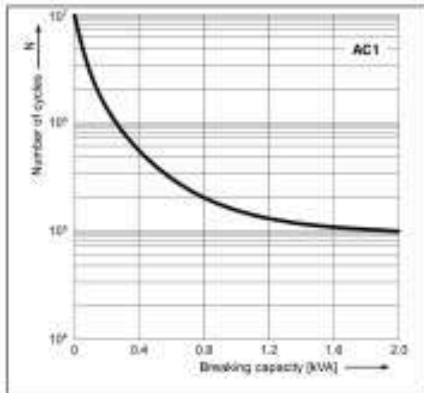

**Electrical life reduction factor at AC inductive load** **Fig. 2.1**

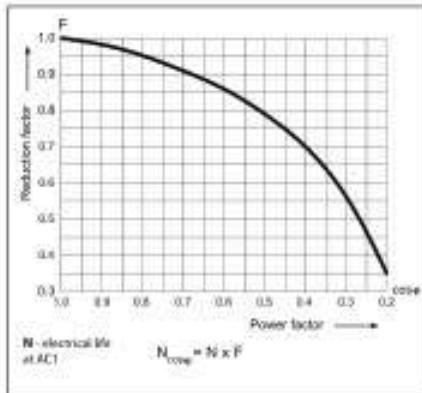

**Max. DC resistive load breaking capacity** **Fig. 3.1**

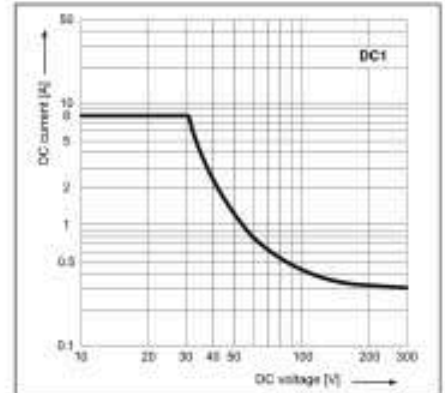

**Coil operating range - DC** **Fig. 4.1**

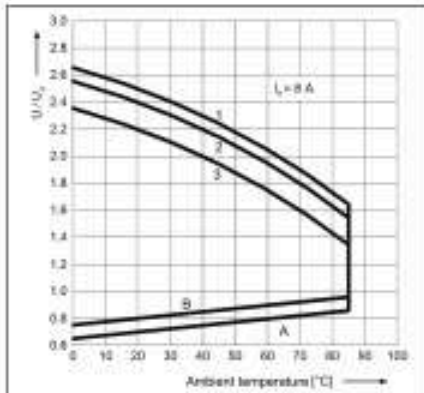

**Coil operating range - AC 50 Hz** **Fig. 5.1**

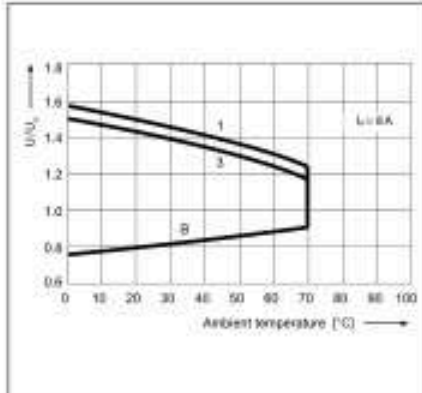

#### Description of Fig. 4.1 and 5.1

**A** - relations between make voltage and ambient temperature at no load on contacts. Coil temperature and ambient temperature are equal before coil energizing. Make voltage is not higher than the value read on Y axis (multiplication of rated voltage).  
**B** - relations between make voltage and ambient temperature after initial coil heating up with 1,1 U<sub>n</sub> at continuous load of I<sub>n</sub> on contacts. Make voltage is not higher than the value read on Y axis (multiplication of rated voltage).  
 1, 2, 3 - values on Y axis represent allowed overvoltage on coil at certain ambient temperature and contact load.  
 1 - no load  
 2 - 50% of rated load  
 3 - rated load

# RM84 / RM85 / RM87

## Miniature Electromagnetic Relays



**RM85**



### CONNECTION DIAGRAM

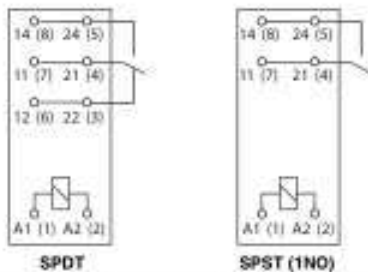

Terminal (pin)	A1 (1), A2 (2)	22 (3), 21 (4), 24 (5), 12 (6), 11 (7), 14 (8)
(mm)	Ø 0.6	0.5 x 0.9
Drilling hole:		
- for relays	Ø 1.3 ± 0.1 mm	
- for sockets	Ø 1.5 ± 0.1 mm	

RM85 terminals are doubled for each contact.  
Both terminals are to be used while connecting to load.

### DIMENSIONS

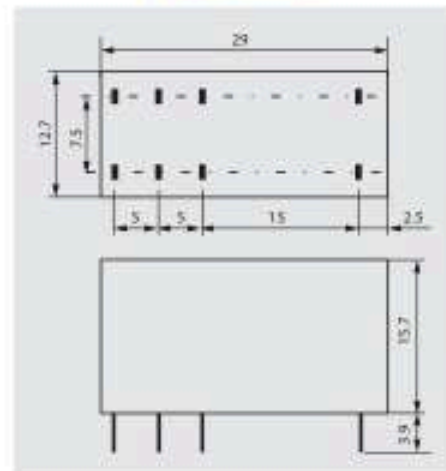

### LOAD CHARTS

**Electrical life at AC resistive load.** Fig. 1.2  
Switching frequency: 600 cycles/hour

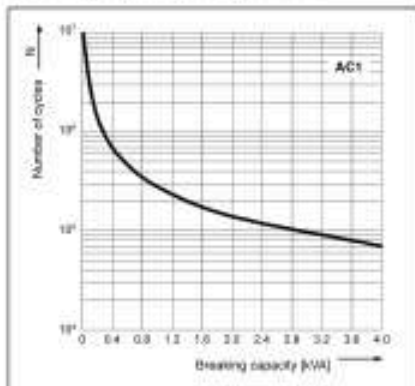

**Electrical life reduction factor at AC inductive load** Fig. 2.2

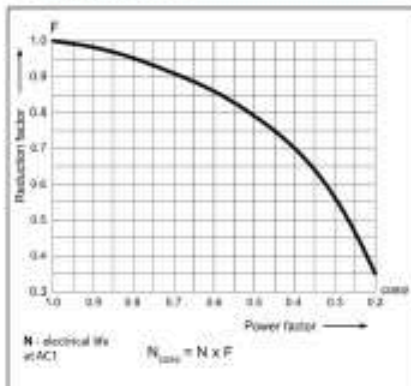

**Max. DC resistive load breaking capacity** Fig. 3.2

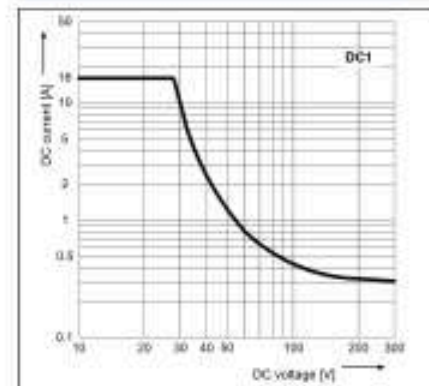

**Coil operating range - DC** Fig. 4.2

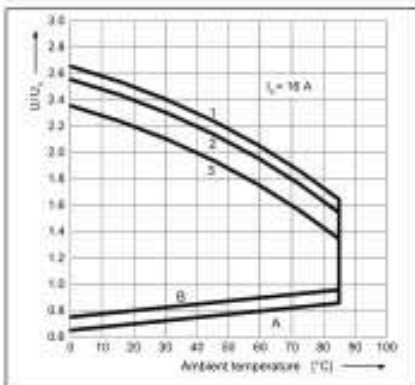

**Coil operating range - AC 50 Hz** Fig. 5.2

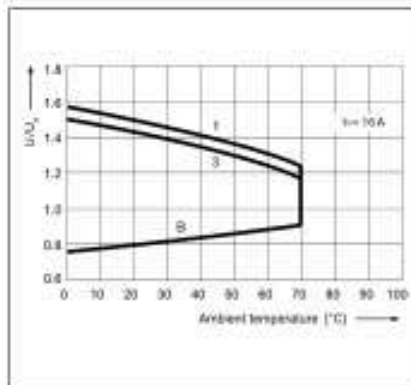

**Description of Fig. 4.2 and 5.2**

**A** - relations between make voltage and ambient temperature at no load on contacts. Coil temperature and ambient temperature are equal before coil energizing. Make voltage is not higher than the value read on Y axis (multiplication of rated voltage).  
**B** - relations between make voltage and ambient temperature after initial coil heating up with 1.1 U<sub>n</sub> at continuous load of I<sub>n</sub> on contacts. Make voltage is not higher than the value read on Y axis (multiplication of rated voltage).  
1, 2, 3 - values on Y axis represent allowed overvoltage on coil at certain ambient temperature and contact load:  
1 - no load  
2 - 50% of rated load  
3 - rated load

# RM84 / RM85 / RM87

## Miniature Electromagnetic Relays

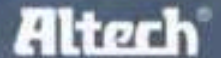

**RM87**



### CONNECTION DIAGRAM

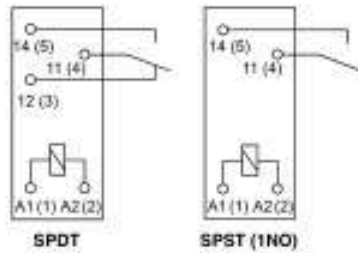

Terminal (pin)	A1(1); A2(2)	12(3); 11(4); 14(5)
[mm]	Ø 0.6	0.5 x 0.9
Drilling hole:		
- for relays	Ø 1.3 ± 0.1 mm	
- for sockets	Ø 1.5 ± 0.1 mm	

### DIMENSIONS

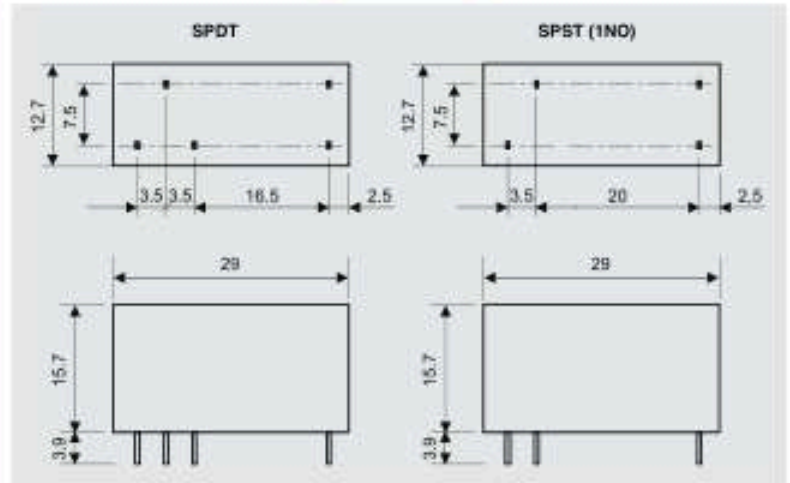

### LOAD CHARTS

Electrical life at AC resistive load. Switching frequency: 600 cycles/hour. Fig. 1.3

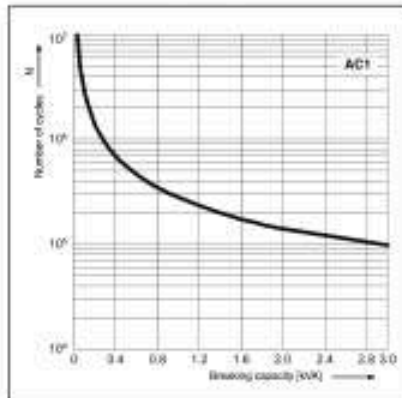

Electrical life reduction factor at AC inductive load. Fig. 2.3

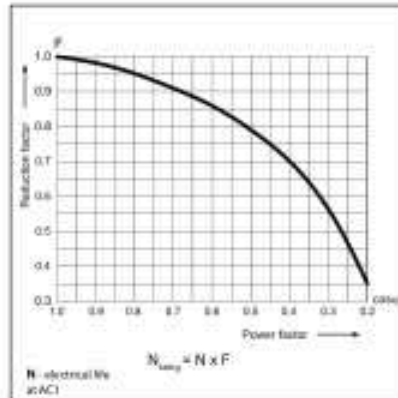

Max. DC resistive load breaking capacity - standard version. Fig. 3.3

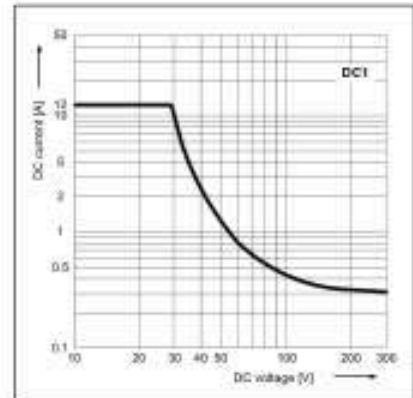

Coil operating range - DC - standard version. Fig. 4.3

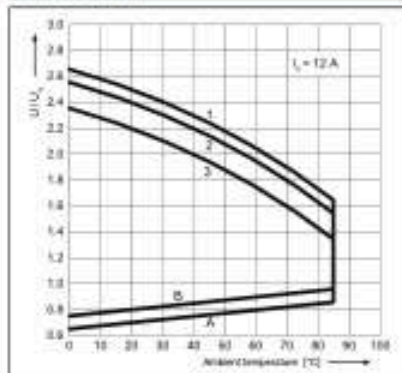

Coil operating range - AC 50 Hz. Fig. 5.3

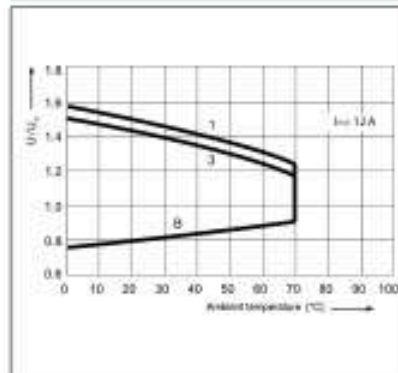

**Description of Fig. 4.3 and 5.3**

**A** - relations between make voltage and ambient temperature at no load on contacts. Coil temperature and ambient temperature are equal before coil energizing. Make voltage is not higher than the value read on Y axis (multiplication of rated voltage). **B** - relations between make voltage and ambient temperature after initial coil heating up with 1.1 U<sub>n</sub> at continuous load of I<sub>n</sub> on contacts. Make voltage is not higher than the value read on Y axis (multiplication of rated voltage).

1, 2, 3 - values on Y axis represent allowed overvoltage on coil at certain ambient temperature and contact load: 1 - no load; 2 - 50% of rated load; 3 - rated load

# RM84 / RM85 / RM87

## Miniature Electromagnetic Relays

### R84 DPDT AC 50/60Hz & DC coil

Part Number	Coil Voltage (V)	Coil Type	Coil resistance at 20 °C in $\Omega$	Coil operating range	
				min. (at 20°C)	max. (at 55°C)
▶ <b>RM84-2012-35-1012</b>	12	DC	360	8.4	30.6
▶ <b>RM84-2012-35-1024</b>	24	DC	1440	16.8	61.2
▶ <b>RM84-2012-35-1110</b>	110	DC	25200	77.0	280.0
▶ <b>RM84-2012-35-5120</b>	120	AC 50/60Hz	10200	96.0	144.0
▶ <b>RM84-2012-35-5230</b>	230	AC 50/60Hz	38500	184.0	276.0

### R84 DPST(2NO) AC 50/60Hz & DC coil

Part Number	Coil Voltage (V)	Coil Type	Coil resistance at 20 °C in $\Omega$	Coil operating range	
				min. (at 20°C)	max. (at 55°C)
▶ <b>RM84-2022-35-1012</b>	12	DC	360	8.4	30.6
▶ <b>RM84-2022-35-1024</b>	24	DC	1440	16.8	61.2
▶ <b>RM84-2022-35-1110</b>	110	DC	25200	77.0	280.0
▶ <b>RM84-2022-35-5120</b>	120	AC 50/60Hz	10200	96.0	144.0
▶ <b>RM84-2022-35-5230</b>	230	AC 50/60Hz	38500	184.0	276.0

### R85 SPDT AC 50/60Hz & DC coil

Part Number	Coil Voltage (V)	Coil Type	Coil resistance at 20 °C in $\Omega$	Coil operating range	
				min. (at 20°C)	max. (at 55°C)
▶ <b>RM85-2011-35-1012</b>	12	DC	360	8.4	30.6
▶ <b>RM85-2011-35-1024</b>	24	DC	1440	16.8	61.2
▶ <b>RM85-2011-35-1110</b>	110	DC	25200	77.0	280.0
▶ <b>RM85-2011-35-5120</b>	120	AC 50/60Hz	10200	96.0	144.0
▶ <b>RM85-2011-35-5230</b>	230	AC 50/60Hz	38500	184.0	276.0

### R85 SPST(1NO) AC 50/60Hz & DC coil

Part Number	Coil Voltage (V)	Coil Type	Coil resistance at 20 °C in $\Omega$	Coil operating range	
				min. (at 20°C)	max. (at 55°C)
▶ <b>RM85-2021-35-1012</b>	12	DC	360	8.4	30.6
▶ <b>RM85-2021-35-1024</b>	24	DC	1440	16.8	61.2
▶ <b>RM85-2021-35-1110</b>	110	DC	25200	77.0	280.0
▶ <b>RM85-2021-35-5120</b>	120	AC 50/60Hz	10200	96.0	144.0
▶ <b>RM85-2021-35-5230</b>	230	AC 50/60Hz	38500	184.0	276.0

### R87 SPDT AC 50/60Hz & DC coil

Part Number	Coil Voltage (V)	Coil Type	Coil resistance at 20 °C in $\Omega$	Coil operating range	
				min. (at 20°C)	max. (at 55°C)
▶ <b>RM87N-2011-35-1012</b>	12	DC	360	8.4	30.6
▶ <b>RM87N-2011-35-1024</b>	24	DC	1440	16.8	61.2
▶ <b>RM87N-2011-35-1110</b>	110	DC	25200	77.0	280.0
▶ <b>RM87N-2011-35-5120</b>	120	AC 50/60Hz	10200	96.0	144.0
▶ <b>RM87N-2011-35-5230</b>	230	AC 50/60Hz	38500	184.0	276.0

### R87 SPST(1NO) AC 50/60Hz & DC coil

Part Number	Coil Voltage (V)	Coil Type	Coil resistance at 20 °C in $\Omega$	Coil operating range	
				min. (at 20°C)	max. (at 55°C)
▶ <b>RM87N-2021-35-1012</b>	12	DC	360	8.4	30.6
▶ <b>RM87N-2021-35-1024</b>	24	DC	1440	16.8	61.2
▶ <b>RM87N-2021-35-1110</b>	110	DC	25200	77.0	280.0
▶ <b>RM87N-2021-35-5120</b>	120	AC 50/60Hz	10200	96.0	144.0
▶ <b>RM87N-2021-35-5230</b>	230	AC 50/60Hz	38500	184.0	276.0

\* waterproof version

▶ **BOLD** - Regular stocked items.

# RM84 / RM85 / RM87

Miniature Electromagnetic Relays - Plug-in Sockets and Accessories **Altech**

## GZT80 (for RM84 / RM85)

Screw terminals  
 Max. tightening moment  
 for the terminal: 0.7 Nm  
 35 mm rail mount  
 acc. to PN-EN 60715  
 or on panel mounting  
 75.3 x 15.5 x 61(67) mm\*  
 Two poles, 5 mm pinout  
 12 A, 300 V AC



E22891



GZT80



ZGGZ80 (see page 170)



GZT80-0040



GZM80-0041\*\*



GZT80-0035



Module type M... (see page 170)

### CONNECTION DIAGRAM

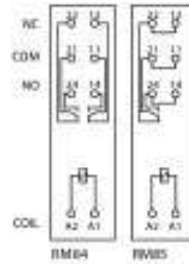

### DIMENSIONS

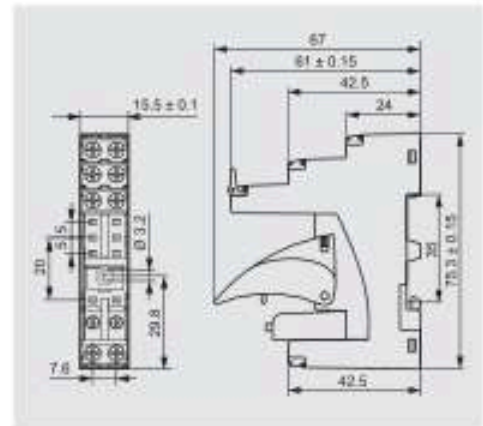

## GZM80 (for RM84 / RM85)

Screw terminals  
 Max. tightening moment  
 for the terminal: 0.7 Nm  
 35 mm rail mount  
 acc. to PN-EN 60715  
 or on panel mounting  
 78.1 x 15.9 x 61(66.5) mm\*  
 Two poles, 5 mm pinout  
 12 A, 300 V AC



E22891



GZM80



ZGGZ80 (see page 170)



GZT80-0040



GZM80-0041\*\*



GZT80-0035



Module type M... (see page 170)

### CONNECTION DIAGRAM

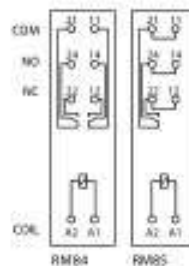

### DIMENSIONS

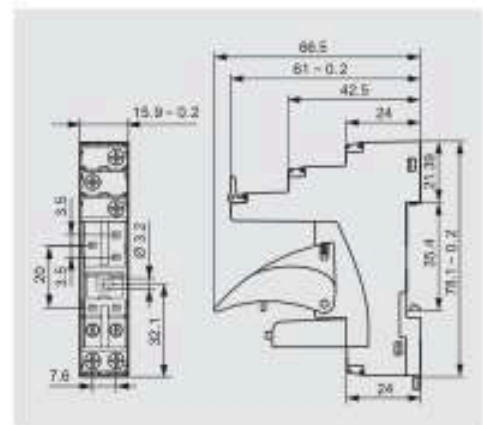

\* In parenthesis is the height of the socket with plastic retainer clip. \*\* For lower profile application.

All accessories are sold separately

# RM84 / RM85 / RM87

## Miniature Electromagnetic Relays - Plug-in Sockets and Accessories

### GZT92 (for RM87)

Screw terminals  
 Max. tightening moment  
 for the terminal: 0.7 Nm  
 35 mm rail mount  
 acc. to PN-EN 60715  
 or on panel mounting  
 75.3 x 15.5 x 61(67) mm\*  
 One pole, 3,5 mm  
 12 A, 300 V AC



GZT92



ZGGZ80 (see page 120)

#### CONNECTION DIAGRAM

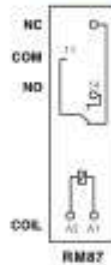

#### DIMENSIONS

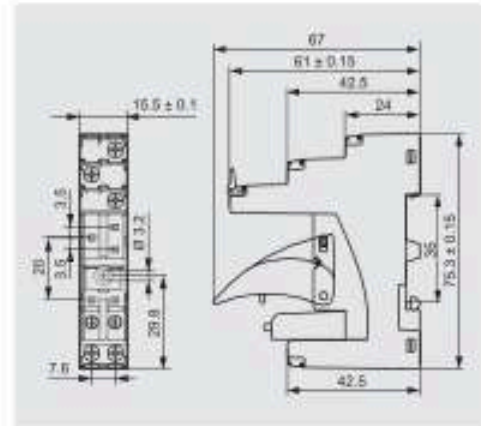

GZT80-0040



GZM80-0041\*\*



GZT80-0035



Module type M... (see page 120)

### GZM92 (for RM87)

Screw terminals  
 Max. tightening moment  
 for the terminal: 0.7 Nm  
 35 mm rail mount  
 acc. to PN-EN 60715  
 or on panel mounting  
 78.1 x 15.9 x 61(66.5) mm\*  
 One pole, 3,5 mm pinout  
 12 A, 300 V AC



GZM92



ZGGZ80 (see page 120)

#### CONNECTION DIAGRAM

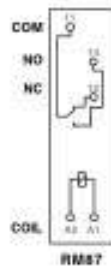

#### DIMENSIONS

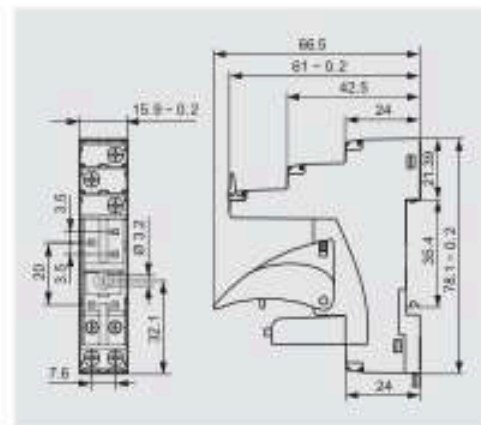

GZT80-0040



GZM80-0041\*\*



GZT80-0035



Module type M... (see page 120)

\* In parenthesis is the height of the socket with plastic retainer clip. \*\* For lower profile application.

All accessories are sold separately

# RM84 / RM85 / RM87

Miniature Electromagnetic Relays - Plug-in Sockets and Accessories **Altech**

## GZMB80 (for RM84, RM85)

Spring terminals  
 Max. cross section of the cables:  
 1 x 0.2...1.5 mm<sup>2</sup>  
 (1 x 24...16 AWG)  
 Stripping length deinsulation:  
 9...11 mm  
 35 mm rail mount  
 acc. to PN-EN 60715  
 97 x 16 x 45.2(69) mm\*  
 Two poles. 5 mm pinout  
 10 A, 300 V AC



GZMB80

### CONNECTION DIAGRAM

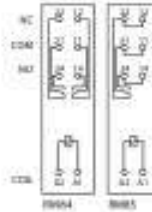

### DIMENSIONS

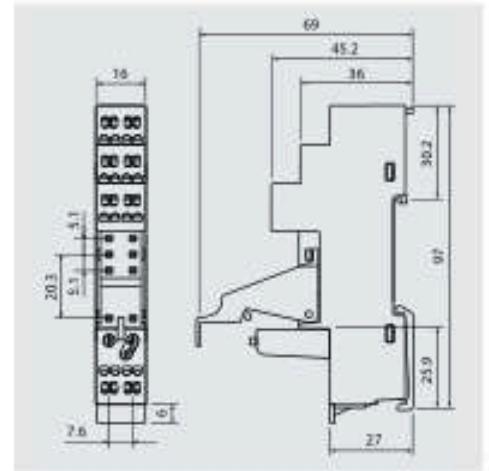

**UL**  
E22891



GZW80-0040



GZW80-0041\*\*



TR



Module type M... (see page 112)

## GD50 (for RM84, RM85)

For RM84, RM85

For PCB  
 31.5 x 13 x 9 mm  
 Two poles. 5 mm pinout  
 8 A, 300 V AC



GD50

### CONNECTION DIAGRAM



### DIMENSIONS

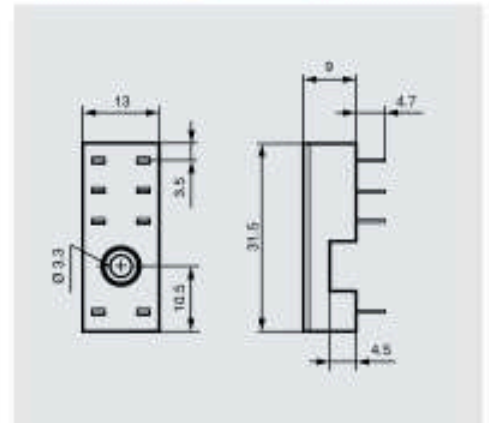

**UL**  
E22891



MH16-2

## GD35 (for RM87N)

For RM87

For PCB  
 31.5 x 13 x 9 mm  
 One pole. 3.5 mm pinout  
 12 A, 300 V AC



GD35

### CONNECTION DIAGRAM



### DIMENSIONS

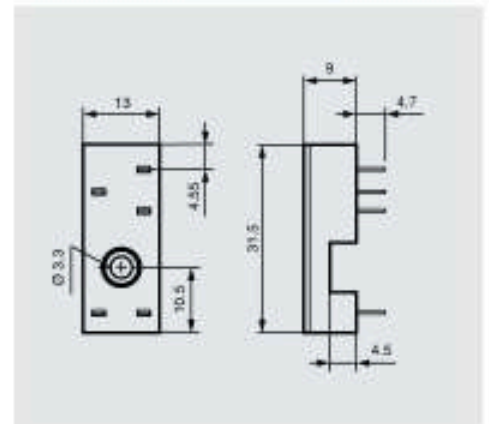

**UL**  
E22891



MH16-2

\* In parenthesis is the height of the socket with plastic retainer clip. \*\* For lower profile application.

All accessories are sold separately

# RSR30

## Slimline Interface Relays



- Optically isolated
- Low on-state resistance
- Low input power consumption
- TTL and CMOS compatible
- RC networks (V AC)
- MOSFET output thyristor (V DC)

- Applications: household appliances, temperature control system, industrial automatic control, light system, office appliances, factory appliances
- Mounting: relays RSR30 are designed for direct PCB mounting, single in line package



### AC Load - 2 A / 240 V

#### Input circuit

Part Number	Nominal voltage V DC	Control voltage range V DC	Max. control current mA	Release voltage V DC	Input resistance kΩ
▶ RSR30-D05-A1-24-020-1	5	3...10	12	1.0	0.32
▶ RSR30-D12-A1-24-020-1	12	7...20	10	1.0	1.07
▶ RSR30-D24-A1-24-020-1	24	18...32	7.7	1.0	3.0

#### Output circuit

Nominal load current	1 A AC see Figure below
Max. load current	2 A AC see Figure below
Nominal load voltage	rest condition: 240 V AC
Load voltage range	12...280 V AC
Non-repetitive peak voltage	rest condition: 600 V AC
Non-repetitive surge current	operating state: 80 A
Max. off-state leakage current	rest condition: 1.5 mA
Max. on-state voltage drop	operating state: 1.2 V
Min. load current	operating state: 50 mA
Off-state dI/dt	max. allowable rate of voltage rise: 500 V/μs
Operating frequency range	47...400 Hz
RC snubber	10 nF, 100 Ω
Operation resistance	-
Peak power dissipation	-
Operating switching frequency	-
Transient voltage suppressor	-
Max voltage of suppressor operation	-

#### General data

Output circuit switching moment	R - instantaneous switching of the output circuit
Max. turn-on time	100 μs at rated voltage
Max. turn-off time	1/2 cycle + 1 ms at rated voltage
Insulation dielectric strength	between input and output: 4 000 V AC 1 minute
Dimensions (L x W x H)	28 x 5 x 15 mm
Weight	4 g
Storage temperature	-40...+100 °C
Operating temperature	-20...+80 °C rated value; +55 °C see Figure below
Max. solder bath temperature	220 °C 10 s

### DIMENSIONS

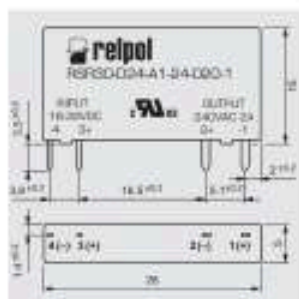

### PIN OUTS

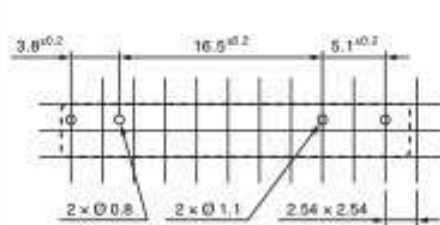

### Load current in the function of the ambient temperature and distances between relays

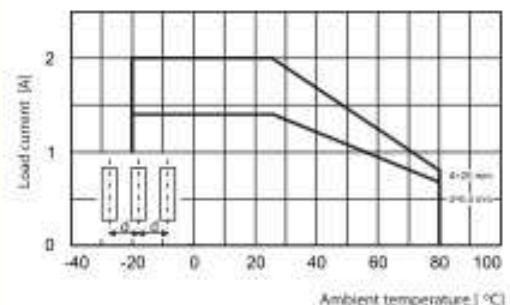

▶ **BOLD** - Regular stocked items.

# RSR30

## Slimline Interface Relays

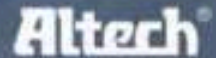

- Optically isolated
- Low on-state resistance
- Low input power consumption
- TTL and CMOS compatible
- RC networks (V AC)
- MOSFET output thyristor (V DC)

- Applications: household appliances, temperature control system, industrial automatic control, light system, office appliances, factory appliances
- Mounting: relays RSR30 are designed for direct PCB mounting, single in line package



### DC Load - 2,5 A / 48 V

#### Input circuit

Part Number	Nominal voltage V DC	Control voltage range V DC	Max. control current mA	Release voltage V DC	Input resistance kΩ
▶ RSR30-005-01-04-025-1	5	3...10	12	1,8	0,32
▶ RSR30-012-01-04-025-1	12	7...20	10	3,6	1,07
▶ RSR30-024-01-04-025-1	24	18...32	7,7	8,3	3,0
▶ RSR30-048-01-04-025-1	48	38...58	4,4	8,3	10,8

### DC Load - 2.5A / 48V

#### Output circuit

Nominal load current	1 A DC see Figure below
Max. load current	2.5 A DC see Figure below
Nominal load voltage	rest condition: 48 V DC
Load voltage range	0...60 V DC
Non-repetitive peak voltage	rest condition: 100 V DC
Non-repetitive surge current	operating state: 6 A
Max. off-state leakage current	rest condition: 1 mA
Max. on-state voltage drop	operating state: 0,4 V
Min. load current	operating state: 1 mA
Off-state dV/dt	-
Operating frequency range	-
RC snubber	-
Operation resistance	operating state: 160 mΩ at rated current
Peak power dissipation	600 W
Operating switching frequency	10 Hz
Transient voltage suppressor	Yes
Max. voltage of suppressor operation	60 V DC

#### General data

Output circuit switching moment	It - instantaneous switching of the output circuit
Max. turn-on time	50 μs at rated voltage
Max. turn-off time	600 μs at rated voltage
Insulation dielectric strength	between input and output: 3 750 V AC 1 minute
Dimensions (L x W x H)	28 x 5 x 15 mm
Weight	4 g
Storage temperature	-25...+100°C
Operating temperature	-20...+80 °C rated value: +55 °C see Figure below
Max. solder bath temperature	220 °C 10 s

### DIMENSIONS

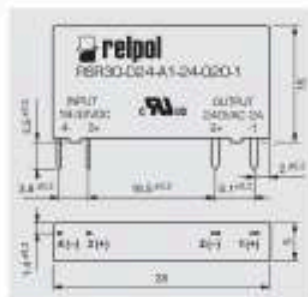

### PIN OUTS

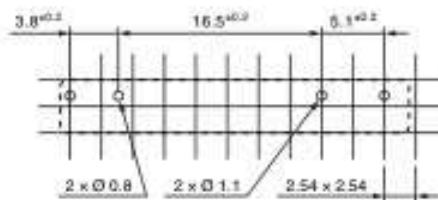

### Load current in the function of the ambient temperature and distances between relays

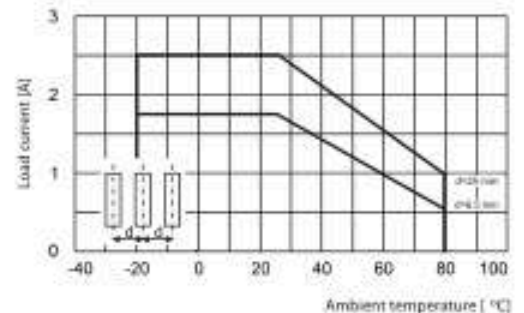

▶ BOLD - Regular stocked items.

# RSR30

## Slimline Interface Relays



### PIR6W-1PS

- Optically isolated
- Low on-state resistance
- Low input power consumption
- TTL and CMOS compatible
- RC networks (V AC)
- MOSFET output thyristor (V DC)

- Applications: household appliances, temperature control system, industrial automatic control, light system, office appliances, factory appliances
- Mounting: relays RSR30 are designed for direct PCB mounting, single in line package



### DC Load - 4 A / 24V Version

#### Input circuit

Part Number	Nominal voltage V DC	Control voltage range V DC	Max. control current mA	Release voltage V DC	Input resistance kΩ
▶ RSR30-005-01-02-040-1	5	3...10	12	1.8	0.32
▶ RSR30-012-01-02-040-1	12	7...20	10	3.6	1.07
▶ RSR30-024-01-02-040-1	24	18...32	7.7	8.3	3.0
▶ RSR30-048-01-02-040-1	48	38...58	4.4	8.3	10.8

#### Output circuit

Nominal load current	2 A DC see Figure below
Max. load current	4 A DC see Figure below
Nominal load voltage	real condition: 24 V DC
Load voltage range	0...32 V DC
Non-repetitive peak voltage	real condition: 60 V DC
Non-repetitive surge current	operating state: 6 A
Max. off-state leakage current	real condition: 1 mA
Max. on-state voltage drop	operating state: 0.24 V
Min. load current	operating state: 1 mA
Off-state dV/dt	-
Operating frequency range	-
RC snubber	-
Operation resistance	operating state: 120 mΩ
Peak power dissipation	600 W
Operating switching frequency	10 Hz
Transient voltage suppressor	Yes
Max. voltage of suppressor operation	36 V DC

#### General data

Output circuit switching moment	H - instantaneous switching of the output circuit
Max. turn-on time	50 μs at rated voltage
Max. turn-off time	600 μs at rated voltage
Insulation dielectric strength	between input and output: 3 750 V AC 1 minute
Dimensions (L x W x H)	28 x 5 x 15 mm
Weight	4 g
Storage temperature	-25...+100 °C
Operating temperature	-20...+80 °C rated value; +55 °C see Figure below
Max. solder bath temperature	220 °C 10 s

### DC Load - 4 A / 24V

#### DIMENSIONS

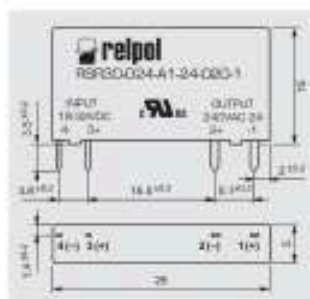

#### PIN OUTS

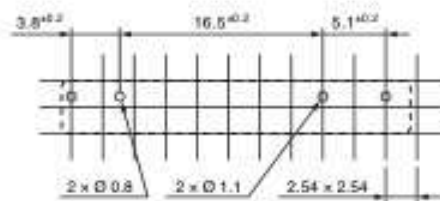

Load current in the function of the ambient temperature and distances between relays

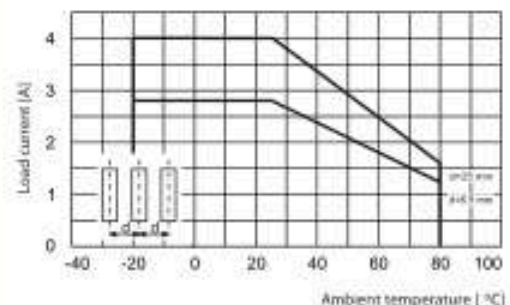

▶ BOLD - Regular stocked items.

# RSR30

## Slimline Interface Relays



### PIR5W-1PS

- Optically isolated
- Low on-state resistance
- Low input power consumption
- TTL and CMOS compatible
- RC networks (V AC)
- MOSFET output thyristor (V DC)

- Applications: household appliances, temperature control system, industrial automatic control, light system, office appliances, factory appliances
- Mounting: relays RSR30 are designed for direct PCB mounting, single in line package



### DC Load - 1 A / 100V Version

#### Input circuit

Part Number	Nominal voltage V DC	Control voltage range V DC	Max. control current mA	Release voltage V DC	Input resistance kΩ
▶ RSR30-D05-01-24-010-1	5	3...10	12	1,8	0,32
▶ RSR30-D12-01-24-010-1	12	7...20	10	3,6	1,07
▶ RSR30-D24-01-24-010-1	24	18...32	7,7	8,3	3,0
▶ RSR30-D48-01-24-010-1	48	38...56	4,4	8,3	10,8

#### Output circuit

Nominal load current	0,4 A DC see Figure below
Max. load current	1 A DC see Figure below
Nominal load voltage	not condition: 100 V DC
Load voltage range	0...180 V DC
Non-repetitive peak voltage	not condition: 180 V DC
Non-repetitive surge current	operating state: 6 A
Max. off-state leakage current	rest condition: 1 mA
Max. on-state voltage drop	operating state: 0,6 V
Min. load current	operating state: 1 mA
Off-state dv/dt	-
Operating frequency range	-
RC snubber	-
Operation resistance	operating state: 1,5 Ω maximum value
Peak power dissipation	800 W
Operating switching frequency	10 Hz
Transient voltage suppressor	Yes
Max. voltage of suppressor operation	180 V DC

#### General data

Output circuit switching moment	R - instantaneous switching of the output circuit
Max. turn-on time	50 μs at rated voltage
Max. turn-off time	800 μs at rated voltage
Insulation dielectric strength	between input and output: 2 500 V AC 1 minute
Dimensions (L x W x H)	28 x 5 x 15 mm
Weight	4 g
Storage temperature	-25...+100 °C
Operating temperature	-20...+80 °C rated value; +55 °C see Figure below
Max. solder bath temperature	220 °C 10 s

### DIMENSIONS

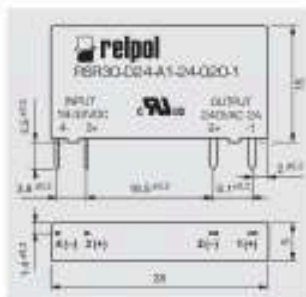

### PIN OUTS

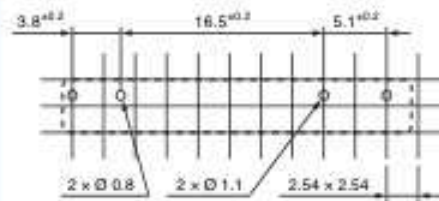

Load current in the function of the ambient temperature and distances between relays

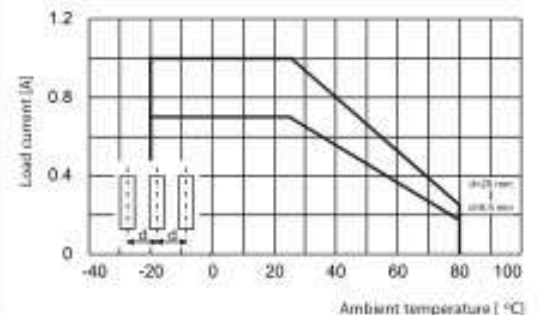

▶ **BOLD** - Regular stocked items.

# RM699B

## Slimline Interface Relays



RM699B  
for PCB mounting  
or plug-in sockets

- Cover width only 5,0 mm
- Sealed for soldering and cleaning
- Applications: for PLC's, industrial machinery, time relays, counters, temperature adjusters, measurement instruments, office equipment, etc.



### RM699B SPDT DC coil / 6A rated current

Part Number	Coil Voltage DC	Coil Type	Coil Resistance at 20°C in Ω	Coil Operating Range	
				min. (at 20°C)	max. (at 55°C)
▶ RM699BV-3011-85-1005	5	DC	147	3.75	7.5
▶ RM699BV-3011-85-1012	12	DC	848	9.0	18.0
▶ RM699BV-3011-85-1024	24	DC	3390	18.0	36.0
▶ RM699BV-3011-85-1048	48	DC	10600	36.0	72.0
▶ RM699BV-3011-85-1060	60	DC	20500	45.0	90.0

### RM699B SPDT gold plated contacts DC coil / 0.05A rated current

Part Number	Coil Voltage DC	Coil Type	Coil Resistance at 20°C in Ω	Coil Operating Range	
				min. (at 20°C)	max. (at 55°C)
RM699BV-3211-85-1005	5	DC	147	3.75	7.5
RM699BV-3211-85-1012	12	DC	848	9.0	18.0
RM699BV-3211-85-1024	24	DC	3390	18.0	36.0
RM699BV-3211-85-1048	48	DC	10600	36.0	72.0
RM699BV-3211-85-1060	60	DC	20500	45.0	90.0

### Contact Data

		RM699B	
		SPDT	SPDT
Number and type of contacts			
Contact material		AgSnO <sub>2</sub>	AgSnO <sub>2</sub> / Au 3µm
Max. switching voltage		400 V AC / 250 V DC	30V AC / 36 V DC
Min. switching voltage		10 V	5V
Rated load		6 A / 250 V AC	0.05 A / 30V AC
	AC1	6 A / 24 V DC; 0.15 A / 250 V DC	0.05 A / 36 V DC
	DC1		
Min. switching current		100 mA	10mA
Max. inrush current		10 A 20 ms	0.1 A 20 ms
Rated current		6A	0.05 A
Max. breaking capacity		1500 VA	1.2 VA
Min. breaking capacity		1 W	0.05 W
Contact resistance		≤ 100 mΩ 100 mA, 24 V	≤ 30 mΩ 10 mA, 5 V
Max. operating frequency			
	• of rated load	360 cycles/hour	360 cycles/hour
	• no load	72000 cycles/hour	72000 cycles/hour

### Coil Data

Rated voltage	DC	5 ... 60 V
Must release voltage		DC: ≤ 0.05 U <sub>n</sub>
Operating range of supply voltage		see table above
Rated power consumption	DC	0.17 W ≤ ... 24V; 0.217 W 48, 60 V

### Insulation

Insulation rated voltage	250 V AC
Overvoltage category	III
Dielectric strength	4 000 V AC type of insulation: reinforced 1 000 V AC type of clearance: micro-disconnection
Contact - coil distance	
• clearance	≥ 6 mm
• creepage	≥ 8 mm

### General data

Operating / release time (typical values)	8 ms / 4 ms
Electrical life (number of cycles)	
• resistive AC1	the SPST (1 NO) and SPST (1 NC) contact loaded (bilateral load): see Fig. 1 the SPST (1 NO) contact loaded: > 3 x 10 <sup>7</sup> ; 6 A, 250 V AC
Mechanical life (cycles)	> 10 <sup>7</sup>
Dimensions (L x W x H)	28 x 5 x 15 mm
Weight	6 g
Ambient temperature	
• storage	-40 ... +85 °C
• operating	-40 ... +85 °C
Cover protection category	IP 64 PN-EN 60529
Environmental protection	RTB PN-EN 116933-3
Shock resistance	5 g
Vibration resistance	5 g 10 ... 55 Hz
Solder bath temperature	max. 260 °C
Soldering time	max. 5 s

### CONNECTION DIAGRAMS

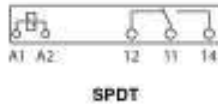

### DIMENSIONS

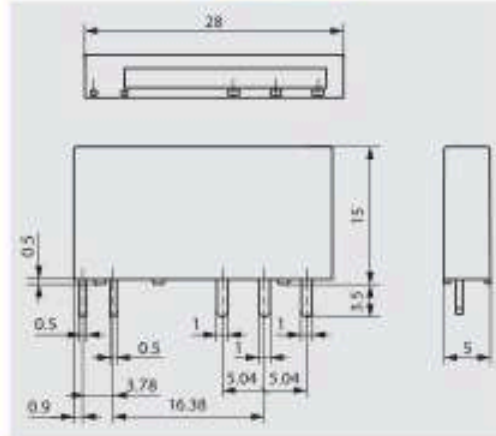

### PIN OUTS

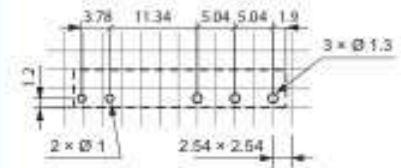

### LOAD CHARTS

Electrical life at AC resistive current.  
Switching frequency: 360 cycles/hour

Fig. 1

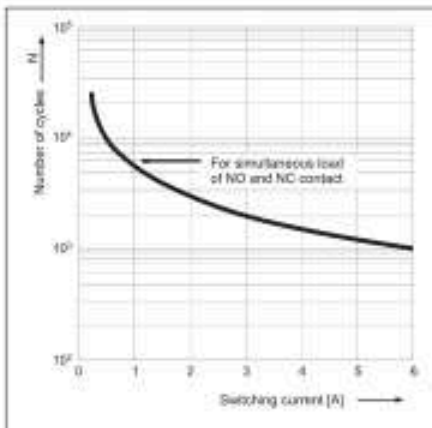

Max. DC resistive load breaking capacity

Fig. 2

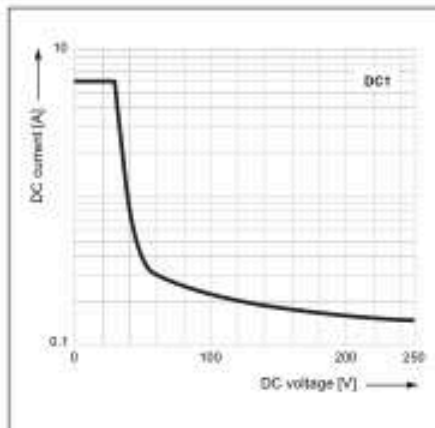

Coil operating range - DC

Fig. 3

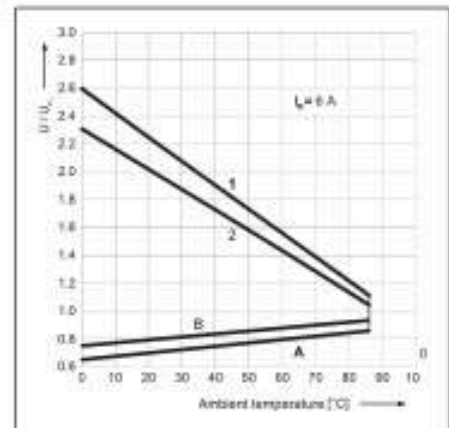

#### Description of Fig. 3

**A** - relations between make voltage and ambient temperature at no load on contacts. Coil temperature and ambient temperature are equal before coil energizing. Make voltage is not higher than the value read on Y axis (multiplication of rated voltage).

**B** - relations between make voltage and ambient temperature after initial coil heating up with  $1.1 U_n$ , at continues load of in on contacts. Make voltage is not higher than the value read on Y axis (multiplication of rated voltage).

1, 2 - values on Y axis represent allowed overvoltage on coil at certain ambient temperature and contact load: 1 - no load; 2 - rated load

### Socket Ordering Codes

Part Number Screw Clamp Terminals	Part Number Spring Clamp Terminals	Rated input voltage $U_n$	Power of input circuit
P16W-1PS-6VDC	P16WB-1PS-6VDC	5 VDC	0.3 W
P16W-1PS-12/24VDC	P16WB-1PS-12/24VDC	12/24 VDC	0.2 W
P16W-1PS-36VDC	P16WB-1PS-36VDC	36 VDC	0.3 W
P16W-1PS-48VDC	P16WB-1PS-48VDC	48 VDC	0.4 W
P16W-1PS-60VDC	P16WB-1PS-60VDC	60 VDC	0.5 W
P16W-1PS-24VAC/DC	P16WB-1PS-24VAC/DC	24 VAC/DC	0.5VA / 0.4W
P16W-1PS-42VAC/DC	P16WB-1PS-42VAC/DC	42 VAC/DC	0.5VA / 0.4W
P16W-1PS-115VAC/DC	P16WB-1PS-115VAC/DC	115 VAC/DC	1.2VA / 1.2W
P16W-1PS-230VAC/DC	P16WB-1PS-230VAC/DC	230 VAC/DC	1.2VA / 1.2W



For relay socket combinations see pages 96-97 (screw clamp terminals) and pages 100-101 (spring clamp terminals).

# PI6-1P / PI6-1T / PI6-OC

## Subminiature Electromagnetic and Solid State Modules

- Width 6,2 mm
- Interface relays PI6-1P - with SPDT contact output / PI6-1T with triac output
- 35 mm rail mount
- Maybe linked with interconnection strip type ZG20
- Equipped in green LED

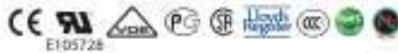

PI6-1P\*

PI6-1T

PI6-OC

### Contact data

	PI6-1P*	PI6-1T	PI6-OC
<b>Number and type of contacts</b>	SPDT	SPST(1NO)	SPST(1NO)
Contact material	AgSnO <sub>2</sub>		
Max. switching voltage	400 V AC / 250 V DC	400 V / 440 V	70 V / 70 V
Min. switching voltage	10 V	20 V	5 V
Rated load	AC1 DC1	6 A / 250 V AC 1.2 A / 400 V AC	0.5 A / 250 V DC
Min. switching current	6 A / 24 V DC, 0.15 A / 250 V DC	10 mA	
Max. inrush current	100 mA		
Max. non-repeat surge current	10 A 20 ms	30 A <sup>2</sup> 1-20 ms	
Rated current	6 A	1.2 A	1.5 A
Max. breaking capacity	AC1 1500 VA		
Min. breaking capacity	1 W		
Contact resistance	≤ 100 mΩ 100 mA, 24 V		
IR for fusing		5.1 A/s 1-10 ms	
dV/dt		50 A/μs	
dI/dt		40 W/μs	
Max. operating frequency			
• at rated load	AC1		
• no load	360 cycles/hour 72 000 cycles/hour		
<b>Input circuit</b>			
Rated voltage	DC 12 ... 36 V	5...32 V	5...32 V
	AC 50/60 Hz AC/DC 24 ... 230 V	24 ... 230 V	24 ... 230 V
Turn-off voltage		AC: ≥ 0.2 U <sub>N</sub> ; DC: ≥ 0.1 U <sub>N</sub>	AC: ≥ 0.2 U <sub>N</sub> ; DC: ≥ 0.1 U <sub>N</sub>
Must release voltage	AC: ≥ 0.2 U <sub>N</sub> ; DC: ≥ 0.1 U <sub>N</sub>		
Operating range of supply voltage	see page B1		
Must operate voltage	AC and DC: ≥ 0.8 U <sub>N</sub>		
Rated power consumption	DC AC/DC AC/DC	0.3 W, 5...32 V DC at 24 V 0.9 VA / 0.3 W, 24 V AC/DC 1.6 VA / 1.6 W, 230 V AC/DC	0.3 W, 5...32 V DC at 24 V 0.3 VA / 0.3 W, 24 V AC/DC 1.0 VA / 1.0 W, 230 V AC/DC
<b>Insulation</b>			
Insulation rated voltage	400 V AC	600 V AC	600 V AC
Rated surge voltage	4 000 V 1.2 / 50 μs		
Overvoltage category	III		
Insulation pollution degree	3	2	2
Dielectric strength			
• input - output	4000 V AC 50/60 Hz, 1 min., type of insulation: reinforced	4000 V AC 50/60 Hz, 1 min., type of insulation: reinforced	3000 V AC, 50/60 Hz, 1 min., type of insulation: reinforced
• input - output	6000 V 1.2 / 50 μs		
• mass - input, output	2500 V AC 50/60 Hz, 1 min.		
• contact clearance	1000 V AC 50/60 Hz, 1 min., type of clearance: micro-disconnection		
Input - output distance			
• clearance / creepage	≥ 6 mm / ≥ 8 mm		
<b>General data</b>			
Operating time (typical value)	AC: 7 ms; DC: 6 ms	10 ms max. (zero turn-on)	
Release time (typical value)	AC: 15 ms; DC: 10 ms	10 ms max.	
Electrical life			
• resistive AC1	> 0.6 × 10 <sup>5</sup> ; 6 A, 250 V AC		
• cos φ = 0.4	> 2 × 10 <sup>5</sup> ; 2 A, 250 V AC		
• resistive DC1	10 <sup>6</sup> ; 6 A, 30 V DC		
Mechanical life (cycles)	> 2 × 10 <sup>7</sup>		
Max. switching frequency			10 kHz 5...32 V DC (for load up to 24 V DC, 15 mW)
Dimensions (L x W x H)	93.8 x 6.2 x 80 mm	93.8 x 6.2 x 80 mm	93.8 x 6.2 x 80 mm
Weight	40 g	40 g	40 g
Ambient temperature			
• storage	-40...+70 °C	-40...+70 °C	-40...+70 °C
• operating	AC: -40...+55 °C; DC (12, 24 V): -40...+60 °C	-40...+55 °C	-40...+55 °C
Protection category	IP 20 PN-EN 60529	IP 20 PN-EN 60529	IP 20 PN-EN 60529
Environmental protection	RT1 PN-EN 116000-3	RT1 PN-EN 116000-3	RT1 PN-EN 116000-3

NO LONGER AVAILABLE

NO LONGER AVAILABLE

NO LONGER AVAILABLE

\* UL Recognized

# PI6-1P / PI6-1T / PI6-OC

Subminiature Electromagnetic and Solid State Modules

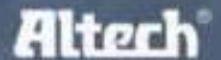

**PI6-1P**



## CONNECTION DIAGRAMS

PI6-1P-12VDC, PI6-1P-12VDC-01  
PI6-1P-24VDC, PI6-1P-24VDC-01  
PI6-1P-36VDC, PI6-1P-36VDC-01

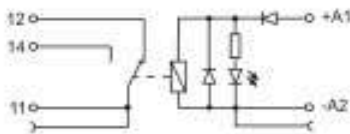

PI6-1P-115VAC/DC  
PI6-1P-230VAC/DC, PI6-1P-230VAC/DC-01

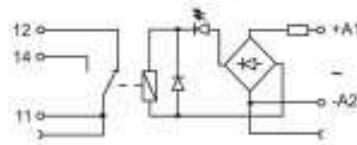

PI6-1P-24VAC/DC, PI6-1P-24VAC/DC-01  
PI6-1P-42VAC/DC

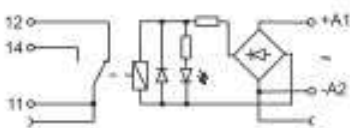

PI6-1P-230VAC/DC-10

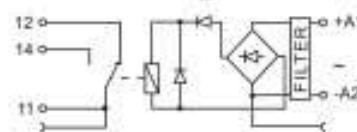

## DIMENSIONS

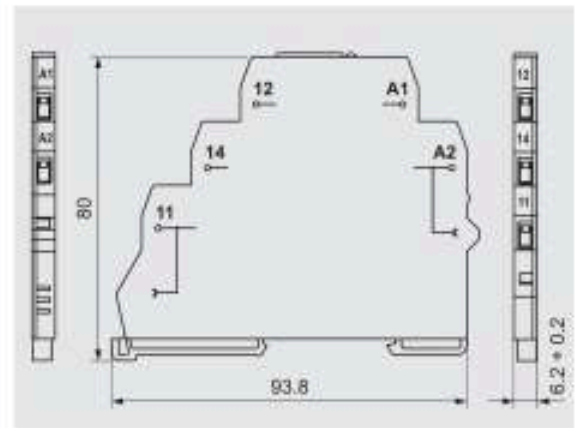

### PI6-1P SPDT AC 50/60Hz & DC coil

Part Number	Rated input voltage $U_n$	Power of input circuit	Input voltage range in V	
			min. (at 20°C)	max. (at 55°C)
PI6-1P-12VDC	12 V DC	0.3 W	9.6	14.1
PI6-1P-24VDC	24 V DC	0.4 W	19.2	28.0
PI6-1P-36VDC	36 V DC	0.7 W	28.8	40.0
<b>PI6-1P-24VAC/DC</b>	24 V AC/DC	0.5 VA / 0.5 W	19.2	26.4
PI6-1P-42VAC/DC	42 V AC/DC	0.3 VA / 0.3 W	33.6	50.0
<b>PI6-1P-115VAC/DC</b>	115 V AC/DC	0.8 VA / 0.8 W	92.0	130.0
PI6-1P-230VAC/DC	230 V AC/DC	0.8 VA / 0.8 W	184.0	253.0

► BOLD - Regular stocked items.

# PI6-1P / PI6-1T / PI6-OC

## Subminiature Electromagnetic and Solid State Modules



**PI6-1T**



### CONNECTION DIAGRAMS

**PI6-1T-5...32VDC**

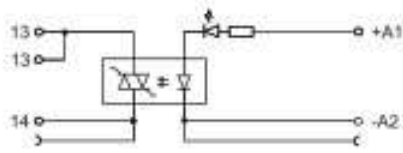

**PI6-1T-24VAC/DC  
PI6-1T-230VAC/DC**

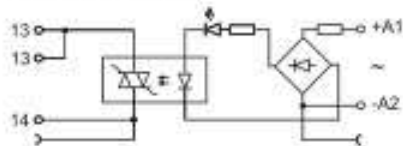

### DIMENSIONS

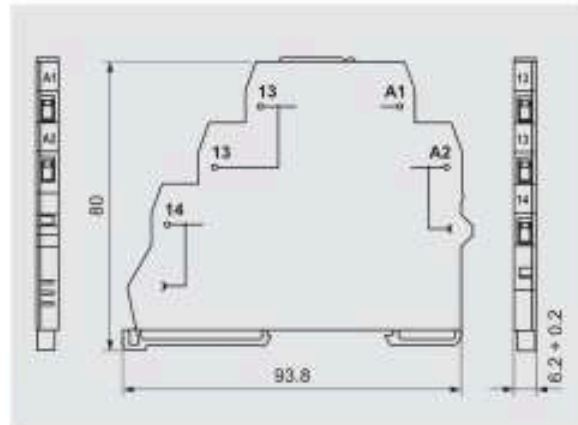

### PI6-1T SPST(1NO) AC 50/60Hz & DC coil

Part Number	Rated input voltage $U_n$	Power of input circuit
▶ <b>PI6-1T-5...32VDC</b>	5...32 V DC	0.3 W at 24V
PI6-1T-24VAC/DC	24 V AC/DC	0.3 VA / 0.3 W
PI6-1T-230VAC/DC	230 V AC/DC	1.6 VA / 1.6 W

▶ **BOLD** - Regular stocked items.

# PI6-1P / PI6-1T / PI6-OC

Subminiature Electromagnetic and Solid State Modules

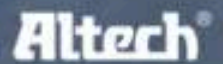

## PI6-OC



### CONNECTION DIAGRAMS

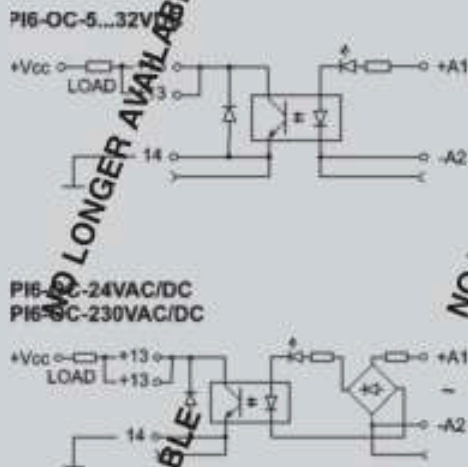

### DIMENSIONS

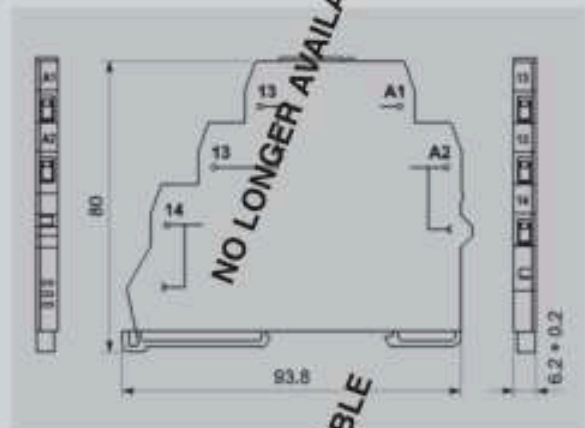

### PI6-OC SPST(1NO) AC 50/60Hz & DC coil

Part Number	Rated input Voltage Un	Power of input circuit
▶ <b>PI6-OC-5...32VDC</b>	5...32 V DC	0.3 W at 24V
PI6-OC-24VAC/DC	24 V AC/DC	0.3 VA / 0.3 W
PI6-OC-230VAC/DC	230 V AC/DC	1.0 VA / 1.0 W

NO LONGER AVAILABLE

NO LONGER AVAILABLE

NO LONGER AVAILABLE

▶ BOLD - Regular stocked items.

# PIR6W-1PS

## Subminiature Electromagnetic and Solid State Modules



- Screw Clamp Terminals
- Electronic screw terminals socket (PI6W-1PS)
- Electromagnetic relay (RM699BV) or solid state relay (RSR30)
- Width 6.2 mm
- Equipped with green LED



### PIR6W-1PS

#### Electromagnetic Relay (RM699BV) contact information

Number and type of contacts (code of output)	SPDT (R)	SPDT (R-01)
Contact material	AgSnO <sub>2</sub>	AgSnO <sub>2</sub> / Au3µm
Max. switching voltage	400 V AC / 250 V DC	30 V AC / 36 V DC
Min. switching voltage	10 V	5 V
Rated load	6 A / 250 V AC 6 A / 24 V DC; 0.15 A / 250 V DC	0.05 A / 30 V AC 0.05 A / 36 V DC
Min. switching current	100 mA	10 mA
Max. inrush current	10 A, 20 ms	0.1 A, 20 ms
Rated current	6A	0.05A
Max. / Min. breaking capacity	1500 VA / 1 W	1.2 VA / 0.05 W
Contact resistance	≤ 100 mΩ 100 mA, 24 V	≤ 30 mΩ 10 mA, 5 V
Max. operating frequency	360 cycles/hour 72 000 cycles/hour	360 cycles/hour 72 000 cycles/hour

#### Solid State (RSR30) output information

Type of output (code of output)	Triac (T) max. 2 A	Transistor (C) max. 1 A	Transistor (D) max. 2 A
Number and type of outputs	SPST (1 NO)	SPST (1 NO)	SPST (1 NO)
Rated voltage	240 V AC	48 V DC	24 V DC
Max. / Min. output voltage	280 V AC / 12 V AC	60 V DC / 1.5 V DC	32 V DC / 1.5 V DC
Rated continuous output current	1A	1A	2A
Min. making capacity current	50 mA	1 mA	1 mA
Max. off-state leakage current (rest condition)	1.5 mA	1 mA	1 mA
Max. on-state voltage drop on the connection (operating state)	1.2 V	0.4 V	0.24 V
Operating switching frequency		10 Hz	10 Hz

#### Input Circuit

Rated voltage	DC AC: 50/60 Hz AC/DC	6 ... 60 V 24 ... 230 V AC: ≥ 0.2 U <sub>N</sub> ; DC: ≥ 0.1 U <sub>N</sub> 0.1...1.2 U <sub>N</sub> ; 0.05...1.2 U <sub>N</sub> ; 6 V DC ≤ 0.8 U <sub>N</sub> ; ≥ 0.85 U <sub>N</sub> ; 6 V DC
Must release voltage		0.2 ... 0.5 W
Operating range of supply voltage		0.5 ... 1.2 VA / 0.4 ... 1.2 W
Must operate voltage		
Rated power consumption	DC AC/DC	

#### Insulation

Insulation rated voltage	250 V AC
Rated surge voltage	4000 V 1.2 / 50 µs
Overvoltage category	II 3
Insulation pollution degree	
Dielectric strength: input - output	4000 V AC 50/60 Hz, 1 min., type of insulation: reinforced
Dielectric strength: input - output	6000 V 1.2 / 50 µs
Dielectric strength: mass - input, output	2500 V AC 50/60 Hz, 1 min.
Dielectric strength: contact clearance	1000 V AC 50/60 Hz, 1 min., output R and R-01
Input - output distance: clearance / creepage	≥ 8 mm / ≥ 8 mm
Mass - input, output distance: clearance / creepage	≥ 3 mm / ≥ 3.6 mm

#### General data

Operating time (typical value)	PIR6W-1PS...-R/-R01: DC: 8 ms AC/DC: 20 ms PIR6W-1PS...-E DC: 100 µs AC/DC: 10 ms PIR6W-1PS...-C/-O: DC: 50 µs AC/DC: 10 ms
Release time (typical value)	PIR6W-1PS...-R/-R01: DC: 10 ms AC/DC: 25 ms PIR6W-1PS...-E DC: 1/2 cycle + 1 ms AC/DC: 30 ms PIR6W-1PS...-C/-O: DC: 600 µs AC/DC: 20 ms
Electrical life (resistive AC1)	PIR6W-1PS...-R: > 0.5 x 10 <sup>7</sup> 6 A, 250 V AC
Mechanical life (cycles)	PIR6W-1PS...-R/-R01: > 10 <sup>7</sup>
Dimensions (L x W x H)	38.5 x 6.2 x 85.5 mm
Weight	45 g
Ambient temperature: storage	PIR6W-1PS...-R/-R01-T: -40...+70 °C ...-C/-O: -25...+70 °C PIR6W-1PS...-R/-R01: -40...+55 °C ...-T/-C/-O: -20...+55 °C PIR6W-1PS-230VAC/DC-R: -40...+50 °C ...-C/-O: -20...+50 °C
Ambient temperature: operating	P 20 PN-EN 60529
Protection category	RII PN-EN 116000-3
Environmental protection	10 g
Shock resistance	5 g 10...500 Hz
Vibration resistance	

T - triac; C - transistor; D - transistor.

# PIR6W-1PS

Subminiature Electromagnetic and Solid State Modules

Altech®



## PIR6W-1PS



### CONNECTION DIAGRAMS

PIR6W-1PS-...-R, PIR6W-1PS-...-R01

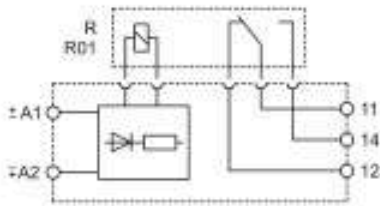

PIR6W-1PS-...-T, PIR6W-1PS-...-C, PIR6W-1PS-...-O

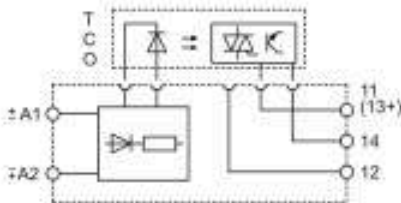

### DIMENSIONS

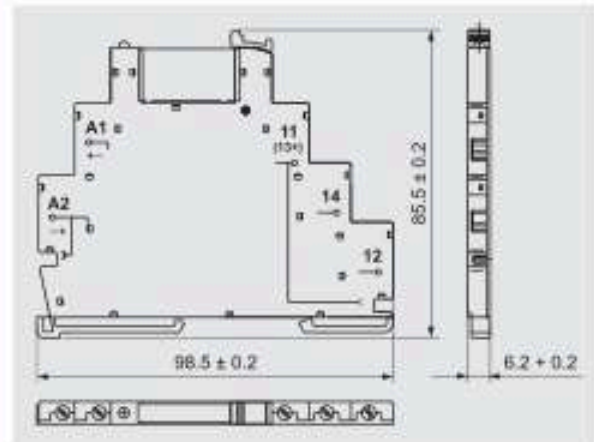

PIR6W-1P-...



RM699BV



RSR30

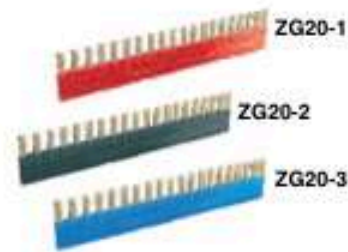

PIR6W-1246



**Green LED:**  
signalling the operation status of the relay.



**Interconnection strip ZG20:**  
bridging of common input or output signals.



**Movable ejector:** protection and easy replacement of the operational relay.

All accessories are sold separately

# PIR6W-1PS

## Subminiature Electromagnetic and Solid State Modules

### Electromagnetic Relays

Featuring **Electromagnetic relay RM699BV / 6A; 250VAC / 24VDC**

Part Number	Rated input voltage $U_N$	Power of input circuit	Socket code	*Operational relay code	Rated voltage of operational relay $U_B$
PIR6W-1PS-6VDC-R	6 V DC	0.3 W	PI6W-1PS-6VDC	RM699BV-3011-85-1005	5 V DC
PIR6W-1PS-12VDC-R	12 V DC	0.2 W	PI6W-1PS-12/24VDC	RM699BV-3011-85-1012	12 V DC
▶ PIR6W-1PS-24VDC-R	24 V DC	0.3 W	PI6W-1PS-12/24VDC	RM699BV-3011-85-1024	24 V DC
PIR6W-1PS-36VDC-R	36 V DC	0.3 W	PI6W-1PS-36VDC	RM699BV-3011-85-1024	24 V DC
PIR6W-1PS-48VDC-R	48 V DC	0.4 W	PI6W-1PS-48VDC	RM699BV-3011-85-1024	24 V DC
PIR6W-1PS-60VDC-R	60 V DC	0.5 W	PI6W-1PS-60VDC	RM699BV-3011-85-1024	24 V DC
▶ PIR6W-1PS-24VAC/DC-R	24 V AC/DC	0.5 VA / 0.4 W	PI6W-1PS-24VAC/DC	RM699BV-3011-85-1012	12 V DC
PIR6W-1PS-42VAC/DC-R	42 V AC/DC	0.5 VA / 0.4 W	PI6W-1PS-42VAC/DC	RM699BV-3011-85-1024	24 V DC
▶ PIR6W-1PS-115VAC/DC-R	115 V AC/DC	1.2 VA / 1.2 W	PI6W-1PS-115VAC/DC	RM699BV-3011-85-1024	24 V DC
PIR6W-1PS-230VAC/DC-R	230 V AC/DC	1.2 VA / 1.2 W	PI6W-1PS-230VAC/DC	RM699BV-3011-85-1048	48 V DC

Featuring **Electromagnetic relay RM699BV / 6A; 250VAC / 24VDC universal input**

Part Number	Rated input voltage $U_N$	Power of input circuit	Socket code	*Operational relay code	Rated voltage of operational relay $U_B$
▶ PIR6W-1P-12U	12 V DC	0.3 W	PI6W-1P-12VDC	RM699BV-3011-85-1012	12 V DC
▶ PIR6W-1P-24U	24 V AC/DC	0.3 VA / 0.3 W	PI6W-1P-24VAC/DC	RM699BV-3011-85-1024	24 V DC
▶ PIR6W-1P-115U	115 V AC/DC	0.9 VA / 0.9 W	PI6W-1P-115VAC/DC	RM699BV-3011-85-1024	24 V DC
▶ PIR6W-1P-230V AC/DC	230 V AC/DC	0.8 VA / 0.8 W	PI6W-1P-230VAC/DC	RM699BV-3011-85-1060	60 V DC

Featuring **Electromagnetic relay RM699BV / 0.05A; 30VAC / 36VDC, gold plated contacts**

Part Number	Rated input voltage $U_N$	Power of input circuit	Socket code	*Operational relay code	Rated voltage of operational relay $U_B$
PIR6W-1PS-6VDC-R01	6 V DC	0.3 W	PI6W-1PS-6VDC	RM699BV-3011-85-1005	5 V DC
PIR6W-1PS-12VDC-R01	12 V DC	0.2 W	PI6W-1PS-12/24VDC	RM699BV-3011-85-1012	12 V DC
PIR6W-1PS-24VDC-R01	24 V DC	0.3 W	PI6W-1PS-12/24VDC	RM699BV-3011-85-1024	24 V DC
PIR6W-1PS-36VDC-R01	36 V DC	0.3 W	PI6W-1PS-36VDC	RM699BV-3011-85-1024	24 V DC
PIR6W-1PS-48VDC-R01	48 V DC	0.4 W	PI6W-1PS-48VDC	RM699BV-3011-85-1024	24 V DC
PIR6W-1PS-60VDC-R01	60 V DC	0.5 W	PI6W-1PS-60VDC	RM699BV-3011-85-1024	24 V DC
▶ PIR6W-1PS-24VAC/DC-R01	24 V AC/DC	0.5 VA / 0.4 W	PI6W-1PS-24VAC/DC	RM699BV-3011-85-1012	12 V DC
PIR6W-1PS-42VAC/DC-R01	42 V AC/DC	0.5 VA / 0.4 W	PI6W-1PS-42VAC/DC	RM699BV-3011-85-1024	24 V DC
PIR6W-1PS-115VAC/DC-R01	115 V AC/DC	1.2 VA / 1.2 W	PI6W-1PS-115VAC/DC	RM699BV-3011-85-1024	24 V DC
PIR6W-1PS-230VAC/DC-R01	230 V AC/DC	1.2 VA / 1.2 W	PI6W-1PS-230VAC/DC	RM699BV-3011-85-1048	48 V DC

\* It should be noted that the rated input voltage of the operational relay ( $U_B$ ) is not always the same as the rated input voltage of the relay and socket combination ( $U_N$ ) (This is important when ordering operational relays for sockets).

## Altech Custom Assemblies

Altech provides quick turnaround and competitive prices on assemblies.

For complete assemblies contact Altech.



▶ BOLD - Regular stocked items.

### Solid State Relays

#### Featuring Solid State Triac (T) relay RSR30 / 2A; 240VAC output

Part Number	Rated input voltage $U_N$	Power of input circuit	Socket code	Operational relay code	Rated voltage of operational relay $U_S$
PIR6W-1PS-6VDC-T	6 V DC	0.2 W	PI6W-1PS-6VDC	RSR30-D05-A1-24-020-1	5 V DC
PIR6W-1PS-12VDC-T	12 V DC	0.2 W	PI6W-1PS-12/24VDC	RSR30-D12-A1-24-020-1	12 V DC
PIR6W-1PS-24VDC-T	24 V DC	0.3 W	PI6W-1PS-12/24VDC	RSR30-D24-A1-24-020-1	24 V DC
PIR6W-1PS-36VDC-T	36 V DC	0.3 W	PI6W-1PS-36VDC	RSR30-D24-A1-24-020-1	24 V DC
PIR6W-1PS-48VDC-T	48 V DC	0.4 W	PI6W-1PS-48VDC	RSR30-D24-A1-24-020-1	24 V DC
PIR6W-1PS-60VDC-T	60 V DC	0.5 W	PI6W-1PS-60VDC	RSR30-D24-A1-24-020-1	24 V DC
► <b>PIR6W-1PS-24VAC/DC-T</b>	24 V AC/DC	0.5 VA / 0.4 W	PI6W-1PS-24VAC/DC	RSR30-D12-A1-24-020-1	12 V DC
PIR6W-1PS-42VAC/DC-T	42 V AC/DC	0.5 VA / 0.4 W	PI6W-1PS-42VAC/DC	RSR30-D24-A1-24-020-1	24 V DC
PIR6W-1PS-115VAC/DC-T	115 V AC/DC	1.0 VA / 1.0 W	PI6W-1PS-115VAC/DC	RSR30-D24-A1-24-020-1	24 V DC

#### Featuring Solid State Transistor (C) relay RSR30 / 1A; 48VDC output

Part Number	Rated input voltage $U_N$	Power of input circuit	Socket code	Operational relay code	Rated voltage of operational relay $U_S$
PIR6W-1PS-6VDC-C	6 V DC	0.2 W	PI6W-1PS-6VDC	RSR30-D05-D1-04-025-1	5 V DC
PIR6W-1PS-12VDC-C	12 V DC	0.2 W	PI6W-1PS-12/24VDC	RSR30-D12-D1-04-025-1	12 V DC
PIR6W-1PS-24VDC-C	24 V DC	0.3 W	PI6W-1PS-12/24VDC	RSR30-D24-D1-04-025-1	24 V DC
PIR6W-1PS-36VDC-C	36 V DC	0.3 W	PI6W-1PS-36VDC	RSR30-D24-D1-04-025-1	24 V DC
PIR6W-1PS-48VDC-C	48 V DC	0.4 W	PI6W-1PS-48VDC	RSR30-D24-D1-04-025-1	24 V DC
PIR6W-1PS-60VDC-C	60 V DC	0.5 W	PI6W-1PS-60VDC	RSR30-D24-D1-04-025-1	24 V DC
► <b>PIR6W-1PS-24VAC/DC-C</b>	24 V AC/DC	0.5 VA / 0.4 W	PI6W-1PS-24VAC/DC	RSR30-D12-D1-04-025-1	12 V DC
PIR6W-1PS-42VAC/DC-C	42 V AC/DC	0.5 VA / 0.4 W	PI6W-1PS-42VAC/DC	RSR30-D24-D1-04-025-1	24 V DC
PIR6W-1PS-115VAC/DC-C	115 V AC/DC	1.0 VA / 1.0 W	PI6W-1PS-115VAC/DC	RSR30-D24-D1-04-025-1	24 V DC
PIR6W-1PS-230VAC/DC-C	230 V AC/DC	1.0 VA / 1.0 W	PI6W-1PS-230VAC/DC	RSR30-D48-D1-04-025-1	48 V DC

#### Featuring Solid State Transistor (O) relay RSR30 / 2A; 24VDC output

Part Number	Rated input voltage $U_N$	Power of input circuit	Socket code	Operational relay code	Rated voltage of operational relay $U_S$
PIR6W-1PS-6VDC-O	6 V DC	0.2 W	PI6W-1PS-6VDC	RSR30-D05-D1-02-040-1	5 V DC
PIR6W-1PS-12VDC-O	12 V DC	0.2 W	PI6W-1PS-12/24VDC	RSR30-D12-D1-02-040-1	12 V DC
PIR6W-1PS-24VDC-O	24 V DC	0.3 W	PI6W-1PS-12/24VDC	RSR30-D24-D1-02-040-1	24 V DC
PIR6W-1PS-36VDC-O	36 V DC	0.3 W	PI6W-1PS-36VDC	RSR30-D24-D1-02-040-1	24 V DC
PIR6W-1PS-48VDC-O	48 V DC	0.4 W	PI6W-1PS-48VDC	RSR30-D24-D1-02-040-1	24 V DC
PIR6W-1PS-60VDC-O	60 V DC	0.5 W	PI6W-1PS-60VDC	RSR30-D24-D1-02-040-1	24 V DC
► <b>PIR6W-1PS-24VAC/DC-O</b>	24 V AC/DC	0.5 VA / 0.4 W	PI6W-1PS-24VAC/DC	RSR30-D12-D1-02-040-1	12 V DC
PIR6W-1PS-42VAC/DC-O	42 V AC/DC	0.5 VA / 0.4 W	PI6W-1PS-42VAC/DC	RSR30-D24-D1-02-040-1	24 V DC
PIR6W-1PS-115VAC/DC-O	115 V AC/DC	1.0 VA / 1.0 W	PI6W-1PS-115VAC/DC	RSR30-D24-D1-02-040-1	24 V DC
PIR6W-1PS-230VAC/DC-O	230 V AC/DC	1.0 VA / 1.0 W	PI6W-1PS-230VAC/DC	RSR30-D48-D1-02-040-1	48 V DC

It should be noted that the rated input voltage of the operational relay ( $U_S$ ) is not always the same as the rated input voltage of the relay and socket combination ( $U_N$ ). (This is important when ordering operational relays for sockets).

► **BOLD** - Regular stocked items.

# PIR6WB-1PS

## Subminiature Electromagnetic and Solid State Modules



- Spring Clamp Terminals
- Electronic **spring** terminals socket (PI6W-1PS)
- Electromagnetic relay (RM699BV) or solid state relay (RSR30)
- Width 6.2 mm
- Equipped with green LED



PIR6WB-1PS

### Electromagnetic Relay (RM699BV) contact information

Number and type of contacts (code of output)	SPDT (R)	SPDT (R-01)
Contact material	AgSnO <sub>2</sub>	AgSnO <sub>2</sub> / Au3µm
Max. switching voltage	400 V AC / 250 V DC	30 V AC / 36 V DC
Min. switching voltage	10 V	5 V
Rated load	8 A / 250 V AC	0.05 A / 30 V AC
	6 A / 24 V DC, 0.15 A / 250 V DC	0.05 A / 36 V DC
Min. switching current	100 mA	10 mA
Max. inrush current	10 A, 20 ms	0.1 A, 20 ms
Rated current	6 A	0.05 A
Max. / Min. breaking capacity	1500 VA / 1 W	1.2 VA / 0.05 W
Contact resistance	≤ 100 mΩ, 100 mA, 24 V	≤ 30 mΩ, 10 mA, 5 V
Max. operating frequency		
• at rated load	360 cycles/hour	360 cycles/hour
• no load	72 000 cycles/hour	72 000 cycles/hour

### Solid State (RSR30) output information

Type of output (code of output)	Triac (T) max. 2 A	Transistor (C) max. 1 A	Transistor (D) max. 2 A
Number and type of outputs	SPST (1 NO)	SPST (1 NO)	SPST (1 NO)
Rated voltage	240 V AC	48 V DC	24 V DC
Max. / Min. output voltage	280 V AC / 12 V AC	60 V DC / 1.5 V DC	32 V DC / 1.5 V DC
Rated continuous output current	1 A	1 A	2 A
Min. making capacity current	50 mA	1 mA	1 mA
Max. off-state leakage current (rest condition)	1.5 mA	1 mA	1 mA
Max. on-state voltage drop on the connection (operating state)	1.2 V	0.4 V	0.24 V
Operating switching frequency		10 Hz	10 Hz

### Input Circuit

Rated voltage	DC AC: 50/60 Hz AC/DC	5 ... 60 V 24 ... 230 V
Must release voltage		AC: ≥ 0.2 U <sub>N</sub> ; DC: ≥ 0.1 U <sub>N</sub>
Operating range of supply voltage		0.8...1.2 U <sub>N</sub> ; 0.85...1.2 U <sub>N</sub> 6 V DC
Must operate voltage		≤ 0.8 U <sub>N</sub> ; ≤ 0.85 U <sub>N</sub> 6 V DC
Rated power consumption	DC AC/DC	0.2 ... 0.5 W 0.5 ... 1.2 VA / 0.4 ... 1.2 W

### Insulation

Insulation rated voltage	250 V AC
Rated surge voltage	4000 V 1.2 / 50 µs
Overvoltage category	III
Insulation pollution degree	3
Dielectric strength: input - output	4000 V AC 50/60 Hz, 1 min., type of insulation: reinforced
Dielectric strength: input - output	6000 V 1.2 / 50 µs
Dielectric strength: contact clearance	1000 V AC 50/60 Hz, 1 min., output R and R-01
Input - output distance: clearance / creepage	≥ 6 mm / ≥ 8 mm

### General data

Operating time (typical value)	PIR6W-1PS...-R/-R01: DC: 8 ms AC/DC: 20 ms PIR6W-1PS...-T: DC: 100 µs AC/DC: 10 ms PIR6W-1PS...-C/-0: DC: 50 µs AC/DC: 10 ms
Release time (typical value)	PIR6W-1PS...-R/-R01: DC: 10 ms AC/DC: 25 ms PIR6W-1PS...-T: DC: 1/2 cycle + 1 ms AC/DC: 30 ms PIR6W-1PS...-C/-0: DC: 600 µs AC/DC: 20 ms PIR6W-1PS...-P: > 0.5 x 10 <sup>7</sup> 6 A, 250 V AC PIR6W-1PS...-R/-R01: > 10 <sup>7</sup>
Electrical life (resistive AC)	
Mechanical life (cycles)	
Dimensions (L x W x H)	98.5 x 6.2 x 84.6 mm
Weight	55 g
Ambient temperature: storage	PIR6W-1PS...-R/-R01-E: -40...+70 °C -C/-0: -25...+70 °C
Ambient temperature: operating	PIR6W-1PS...-R/-R01: -40...+55 °C -T/-C/-0: -20...+55 °C
Protection category	P 20 PN-EN 60529
Environmental protection	R71 PN-EN 116000-3
Shock resistance	10 g
Vibration resistance	5 g 10...500 Hz

T - triac; C - transistor; 0 - transistor.

# PIR6WB-1PS

Subminiature Electromagnetic and Solid State Modules

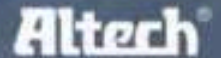

## PIR6WB-1PS



### CONNECTION DIAGRAMS

PIR6WB-1PS-...-R, PIR6WB-1PS-...-R01

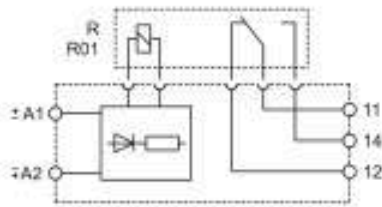

PIR6WB-1P-230VAC/DC-10

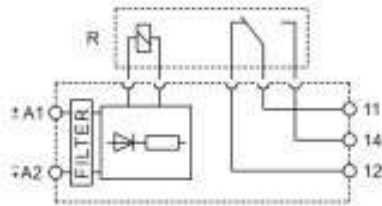

PIR6WB-1PS-...-T, PIR6WB-1PS-...-C, PIR6WB-1PS-...-O

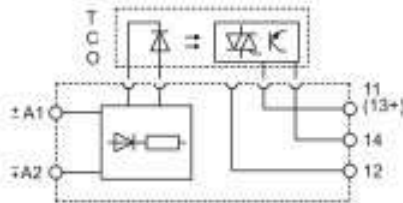

### DIMENSIONS

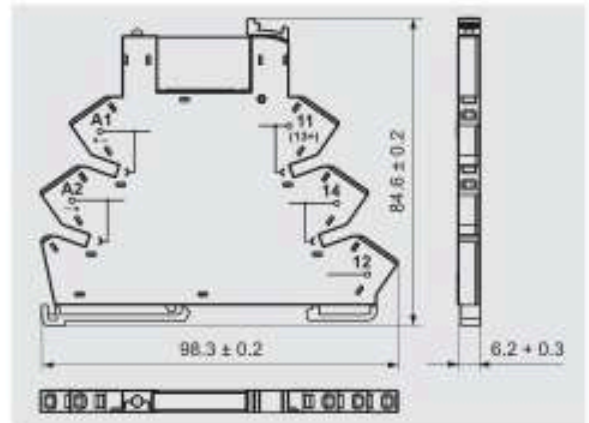

PI6WB-1PS-...



RM699BV



RSR30

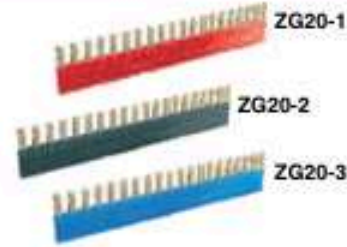

ZG20-1

ZG20-2

ZG20-3



PI6W-1246



**Green LED:**  
signalling the operation  
status of the relay.



**Interconnection strip ZG20:**  
bridging of common  
input or output signals.



**Movable ejector:** protection  
and easy replacement  
of the operational relay.

All accessories are sold separately

# PIR6WB-1PS

## Subminiature Electromagnetic and Solid State Modules

### Electromagnetic Relays

Featuring **Electromagnetic relay RM699BV / 6A; 250VAC / 24VDC**

Part Number	Rated input voltage $U_N$	Power of input circuit	Socket code	Operational relay code	Rated voltage of operational relay $U_S$
PIR6WB-1PS-6VDC-R	6 V DC	0.3 W	PI6WB-1PS-6VDC	RM699BV-3011-85-1005	5 V DC
PIR6WB-1PS-12VDC-R	12 V DC	0.2 W	PI6WB-1PS-12/24VDC	RM699BV-3011-85-1012	12 V DC
► <b>PIR6WB-1PS-24VDC-R</b>	24 V DC	0.3 W	PI6WB-1PS-12/24VDC	RM699BV-3011-85-1024	24 V DC
PIR6WB-1PS-36VDC-R	36 V DC	0.3 W	PI6WB-1PS-36VDC	RM699BV-3011-85-1024	24 V DC
PIR6WB-1PS-48VDC-R	48 V DC	0.4 W	PI6WB-1PS-48VDC	RM699BV-3011-85-1024	24 V DC
PIR6WB-1PS-60VDC-R	60 V DC	0.5 W	PI6WB-1PS-60VDC	RM699BV-3011-85-1024	24 V DC
► <b>PIR6WB-1PS-24VAC/DC-R</b>	24 V AC/DC	0.5 VA / 0.4 W	PI6WB-1PS-24VAC/DC	RM699BV-3011-85-1012	12 V DC
PIR6WB-1PS-42VAC/DC-R	42 V AC/DC	0.5 VA / 0.4 W	PI6WB-1PS-42VAC/DC	RM699BV-3011-85-1024	24 V DC
► <b>PIR6WB-1PS-115VAC/DC-R</b>	115 V AC/DC	1.2 VA / 1.2 W	PI6WB-1PS-115VAC/DC	RM699BV-3011-85-1024	24 V DC
PIR6WB-1PS-230VAC/DC-R	230 V AC/DC	1.2 VA / 1.2 W	PI6WB-1PS-230VAC/DC	RM699BV-3011-85-1048	48 V DC

Featuring **Electromagnetic relay RM699BV / 0.05A; 30VAC / 36VDC. gold plated contacts**

Part Number	Rated input voltage $U_N$	Power of input circuit	Socket code	Operational relay code	Rated voltage of operational relay $U_S$
PIR6WB-1PS-6VDC-R01	6 V DC	0.3 W	PI6WB-1PS-6VDC	RM699BV-3011-85-1005	5 V DC
PIR6WB-1PS-12VDC-R01	12 V DC	0.2 W	PI6WB-1PS-12/24VDC	RM699BV-3011-85-1012	12 V DC
PIR6WB-1PS-24VDC-R01	24 V DC	0.3 W	PI6WB-1PS-12/24VDC	RM699BV-3011-85-1024	24 V DC
PIR6WB-1PS-36VDC-R01	36 V DC	0.3 W	PI6WB-1PS-36VDC	RM699BV-3011-85-1024	24 V DC
PIR6WB-1PS-48VDC-R01	48 V DC	0.4 W	PI6WB-1PS-48VDC	RM699BV-3011-85-1024	24 V DC
PIR6WB-1PS-60VDC-R01	60 V DC	0.5 W	PI6WB-1PS-60VDC	RM699BV-3011-85-1024	24 V DC
► <b>PIR6WB-1PS-24VAC/DC-R01</b>	24 V AC/DC	0.5 VA / 0.4 W	PI6WB-1PS-24VAC/DC	RM699BV-3011-85-1012	12 V DC
PIR6WB-1PS-42VAC/DC-R01	42 V AC/DC	0.5 VA / 0.4 W	PI6WB-1PS-42VAC/DC	RM699BV-3011-85-1024	24 V DC
PIR6WB-1PS-115VAC/DC-R01	115 V AC/DC	1.2 VA / 1.2 W	PI6WB-1PS-115VAC/DC	RM699BV-3011-85-1024	24 V DC
PIR6WB-1PS-230VAC/DC-R01	230 V AC/DC	1.2 VA / 1.2 W	PI6WB-1PS-230VAC/DC	RM699BV-3011-85-1048	48 V DC

The rated input voltage of the operational relay  $U_S$  not always complies with the rated input voltage  $U_N$  (which is important on ordering operational relays for sockets). For versions of the input voltage  $U_N = 230$  V AC/DC keep the distance between the mounting relays min. 5 mm under maximum load and at continuous operation.

## Altech Custom Assemblies



**Altech provides quick turnaround and competitive prices on assemblies.**

For complete assemblies contact Altech.

► **BOLD** - Regular stocked items.

### Solid State Relays

#### Featuring Solid State Triac (T) relay RSR30 / 2A; 240VAC output

Part Number	Rated input voltage $U_N$	Power of input circuit	Socket code	Operational relay code	Rated voltage of operational relay $U_S$
PIR6WB-1PS-6VDC-T	6 V DC	0.2 W	PI6WB-1PS-6VDC	RSR30-D05-A1-24-020-1	5 V DC
PIR6WB-1PS-12VDC-T	12 V DC	0.2 W	PI6WB-1PS-12/24VDC	RSR30-D12-A1-24-020-1	12 V DC
PIR6WB-1PS-24VDC-T	24 V DC	0.3 W	PI6WB-1PS-12/24VDC	RSR30-D24-A1-24-020-1	24 V DC
PIR6WB-1PS-36VDC-T	36 V DC	0.3 W	PI6WB-1PS-36VDC	RSR30-D24-A1-24-020-1	24 V DC
PIR6WB-1PS-48VDC-T	48 V DC	0.4 W	PI6WB-1PS-48VDC	RSR30-D24-A1-24-020-1	24 V DC
PIR6WB-1PS-60VDC-T	60 V DC	0.5 W	PI6WB-1PS-60VDC	RSR30-D24-A1-24-020-1	24 V DC
► PIR6WB-1PS-24VAC/DC-T	24 V AC/DC	0.5 VA / 0.4 W	PI6WB-1PS-24VAC/DC	RSR30-D12-A1-24-020-1	12 V DC
PIR6WB-1PS-42VAC/DC-T	42 V AC/DC	0.5 VA / 0.4 W	PI6WB-1PS-42VAC/DC	RSR30-D24-A1-24-020-1	24 V DC
PIR6WB-1PS-115VAC/DC-T	115 V AC/DC	1.0 VA / 1.0 W	PI6WB-1PS-115VAC/DC	RSR30-D24-A1-24-020-1	24 V DC

#### Featuring Solid State transistor (C) relay RSR30 / 1A; 48VDC output

Part Number	Rated input voltage $U_N$	Power of input circuit	Socket code	Operational relay code	Rated voltage of operational relay $U_S$
PIR6WB-1PS-6VDC-C	6 V DC	0.2 W	PI6WB-1PS-6VDC	RSR30-D05-D1-04-025-1	5 V DC
PIR6WB-1PS-12VDC-C	12 V DC	0.2 W	PI6WB-1PS-12/24VDC	RSR30-D12-D1-04-025-1	12 V DC
PIR6WB-1PS-24VDC-C	24 V DC	0.3 W	PI6WB-1PS-12/24VDC	RSR30-D24-D1-04-025-1	24 V DC
PIR6WB-1PS-36VDC-C	36 V DC	0.3 W	PI6WB-1PS-36VDC	RSR30-D24-D1-04-025-1	24 V DC
PIR6WB-1PS-48VDC-C	48 V DC	0.4 W	PI6WB-1PS-48VDC	RSR30-D24-D1-04-025-1	24 V DC
PIR6WB-1PS-60VDC-C	60 V DC	0.5 W	PI6WB-1PS-60VDC	RSR30-D24-D1-04-025-1	24 V DC
► PIR6WB-1PS-24VAC/DC-C	24 V AC/DC	0.5 VA / 0.4 W	PI6WB-1PS-24VAC/DC	RSR30-D12-D1-04-025-1	12 V DC
PIR6WB-1PS-42VAC/DC-C	42 V AC/DC	0.5 VA / 0.4 W	PI6WB-1PS-42VAC/DC	RSR30-D24-D1-04-025-1	24 V DC
PIR6WB-1PS-115VAC/DC-C	115 V AC/DC	1.0 VA / 1.0 W	PI6WB-1PS-115VAC/DC	RSR30-D24-D1-04-025-1	24 V DC
PIR6WB-1PS-230VAC/DC-C	230 V AC/DC	1.0 VA / 1.0 W	PI6WB-1PS-230VAC/DC	RSR30-D48-D1-04-025-1	48 V DC

#### Featuring Solid State transistor (O) relay RSR30 / 2A; 24VDC output

Part Number	Rated input voltage $U_N$	Power of input circuit	Socket code	Operational relay code	Rated voltage of operational relay $U_S$
PIR6WB-1PS-6VDC-O	6 V DC	0.2 W	PI6WB-1PS-6VDC	RSR30-D05-D1-02-040-1	5 V DC
PIR6WB-1PS-12VDC-O	12 V DC	0.2 W	PI6WB-1PS-12/24VDC	RSR30-D12-D1-02-040-1	12 V DC
PIR6WB-1PS-24VDC-O	24 V DC	0.3 W	PI6WB-1PS-12/24VDC	RSR30-D24-D1-02-040-1	24 V DC
PIR6WB-1PS-36VDC-O	36 V DC	0.3 W	PI6WB-1PS-36VDC	RSR30-D24-D1-02-040-1	24 V DC
PIR6WB-1PS-48VDC-O	48 V DC	0.4 W	PI6WB-1PS-48VDC	RSR30-D24-D1-02-040-1	24 V DC
PIR6WB-1PS-60VDC-O	60 V DC	0.5 W	PI6WB-1PS-60VDC	RSR30-D24-D1-02-040-1	24 V DC
► PIR6WB-1PS-24VAC/DC-O	24 V AC/DC	0.5 VA / 0.4 W	PI6WB-1PS-24VAC/DC	RSR30-D12-D1-02-040-1	12 V DC
PIR6WB-1PS-42VAC/DC-O	42 V AC/DC	0.5 VA / 0.4 W	PI6WB-1PS-42VAC/DC	RSR30-D24-D1-02-040-1	24 V DC
PIR6WB-1PS-115VAC/DC-O	115 V AC/DC	1.0 VA / 1.0 W	PI6WB-1PS-115VAC/DC	RSR30-D24-D1-02-040-1	24 V DC
PIR6WB-1PS-230VAC/DC-O	230 V AC/DC	1.0 VA / 1.0 W	PI6WB-1PS-230VAC/DC	RSR30-D48-D1-02-040-1	48 V DC

It should be noted that the rated input voltage of the operational relay ( $U_S$ ) is not always the same as the rated input voltage of the relay and socket combination ( $U_N$ ). (This is important when ordering operational relays for sockets). For versions of the input voltage  $U_N = 230$  V AC/DC keep the distance between the mounting relays min. 5 mm under maximum load and at continuous operation.

► BOLD - Regular stocked items.

# PI84

## Relay Socket Combination

PI84



GTZ80 socket

Relay: RM84 (see page 76 for detailed information)

Socket: GZT80/GZM80 (see page 81 for detailed information)

### Technical Information

Current ..... 8 A  
 Voltage ..... 250V AC / 24V DC  
 Wire Range ..... 2.5 mm<sup>2</sup> / 24-14 AWG  
 Torque ..... 0.7 Nm

PI84



GZM80 socket

### GTZ80 Socket - PI84 DPDT AC 50/60Hz & DC coil

Part Number	Coil Voltage (V)	Coil Type	Coil Resistance at 20°C in Ω	Coil Operating Range		Type of Module
				min. (at 20°C)	max. (at 55°C)	
PI84-12DC-M41G	12	DC	360	8.4	30.6	M41G*
<b>PI84-24DC-M41G</b>	24	DC	1440	16.8	61.2	M41G*
PI84-110DC-M43G	110	DC	25200	77.0	280.0	M43G*
PI84-12DC-M91G	12	DC	360	8.4	30.6	M91G**
<b>PI84-24DC-M91G</b>	24	DC	1440	16.8	61.2	M91G**
PI84-110DC-M93G	110	DC	25200	77.0	280.0	M93G**
<b>PI84-120AC-M93G</b>	120	AC 50/60Hz	10200	96.0	144.0	M93G**
PI84-230AC-M93G	230	AC 50/60Hz	38500	184.0	276.0	M93G**

### GZM80 Socket - PI84 DPDT AC 50/60Hz & DC coil

Part Number	Coil Voltage (V)	Coil Type	Coil Resistance at 20°C in Ω	Coil Operating Range		Type of Module
				min. (at 20°C)	max. (at 55°C)	
PI84-012DC-00LD	12	DC	360	8.4	30.6	M41G*
PI84-024DC-00LD	24	DC	1440	16.8	61.2	M41G*
PI84-110DC-00LD	110	DC	25200	77.0	280.0	M43G*
PI84-012DC-00LV	12	DC	360	8.4	30.6	M91G**
PI84-024DC-00LV	24	DC	1440	16.8	61.2	M91G**
PI84-110DC-00LV	110	DC	25200	77.0	280.0	M93G**
PI84-120AC-00LV	120	AC 50/60Hz	10200	96.0	144.0	M93G**
PI84-230AC-00LV	230	AC 50/60Hz	38500	184.0	276.0	M93G**

\* Module LD (polarization N) it limits overvoltage on DC coils. Coil energizing indication. \*\* Module LV it limits overvoltage on AC and DC coils. Coil energizing indication.

### PI84-GZT80

#### CONNECTION DIAGRAMS

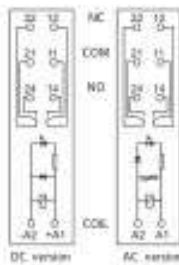

#### DIMENSIONS

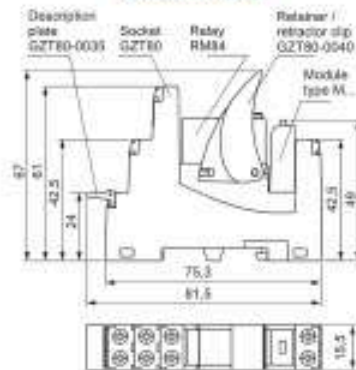

#### CONNECTION

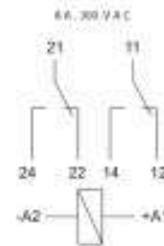

### PI84-GZM80

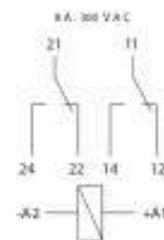
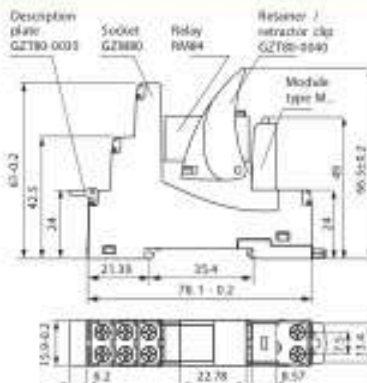
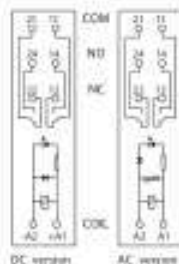

► **BOLD** - Regular stocked items.

All accessories are included

# PI85

## Relay Socket Combination

PI85



GTZ80 socket

Relay: RM85 (see page 76 for detailed information)

Socket: GZT80/GZM80 (see page 81 for detailed information)

### Technical Information

Current .....16 A  
 Voltage.....250V AC / 24V DC  
 Wire Range.....2.5 mm<sup>2</sup> / 24-14 AWG  
 Torque.....0.7 Nm

PI85



GZM80 socket

### GZT80 Socket - PI85 DPDT AC 50/60Hz & DC coil

Part Number	Coil Voltage (V)	Coil Type	Coil Resistance at 20°C in Ω	Coil Operating Range		Type of Module
				min. (at 20°C)	max. (at 55°C)	
PI85-12DC-M41G	12	DC	360	8.4	30.6	M41G*
<b>PI85-24DC-M41G</b>	24	DC	1440	16.8	61.2	M41G*
PI85-110DC-M43G	110	DC	25200	77.0	280.0	M43G*
PI85-12DC-M91G	12	DC	360	8.4	30.6	M91G**
<b>PI85-24DC-M91G</b>	24	DC	1440	16.8	61.2	M91G**
PI85-110DC-M93G	110	DC	25200	77.0	280.0	M93G**
<b>PI85-120AC-M93G</b>	120	AC 50/60Hz	10200	96.0	144.0	M93G**
PI85-230AC-M93G	230	AC 50/60Hz	38500	184.0	276.0	M93G**

### GZM80 Socket - PI85 DPDT AC 50/60Hz & DC coil

Part Number	Coil Voltage (V)	Coil Type	Coil Resistance at 20°C in Ω	Coil Operating Range		Type of Module
				min. (at 20°C)	max. (at 55°C)	
PI85-012DC-00LD	12	DC	360	8.4	30.6	M41G*
PI85-024DC-00LD	24	DC	1440	16.8	61.2	M41G*
PI85-110DC-00LD	110	DC	25200	77.0	280.0	M43G*
PI85-012DC-00LV	12	DC	360	8.4	30.6	M91G**
PI85-024DC-00LV	24	DC	1440	16.8	61.2	M91G**
PI85-110DC-00LV	110	DC	25200	77.0	280.0	M93G**
PI85-120AC-00LV	120	AC 50/60Hz	10200	96.0	144.0	M93G**
PI85-230AC-00LV	230	AC 50/60Hz	38500	184.0	276.0	M93G**

\* Module LD (polarization N) it limits overvoltage on DC coils. Coil energizing indication. \*\* Module LV it limits overvoltage on AC and DC coils. Coil energizing indication.

### PI85-GZT80

#### CONNECTION DIAGRAMS

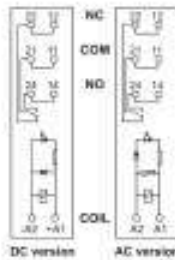

#### DIMENSIONS

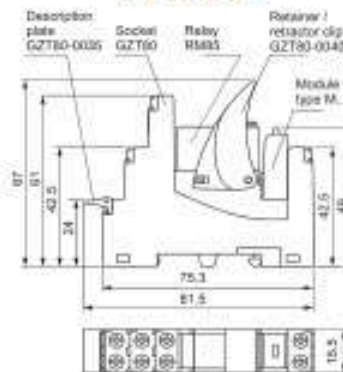

#### CONNECTION

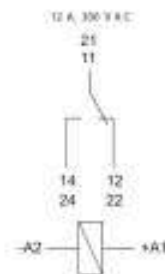

### PI85-GZM80

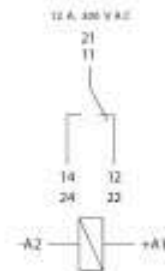
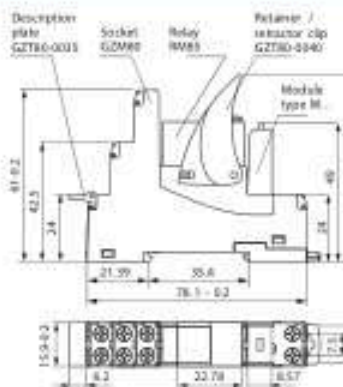
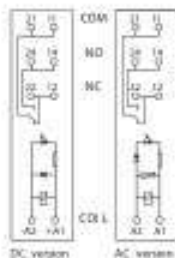

► BOLD - Regular stocked items.

All accessories are included.

# PIR2

## Relay Socket Combination

PIR2



Relay: R2 (see page 50 for detailed information)

Socket: GZM2 (see page 55 for detailed information)

### Technical Information

Current ..... 12 A  
 Voltage.....250V AC / 24V DC  
 Wire Range.....2.5 mm<sup>2</sup> / 24-14 AWG  
 Torque.....0.7 Nm

### PIR2 DPDT AC 50/60Hz & DC coil

Part Number	Coil Voltage (V)	Coil Type	Coil Resistance at 20°C in Ω	Coil Operating Range		Type of Module
				min. (at 20°C)	max. (at 55°C)	
PIR2-0120C-00LD	12	DC	160	9.6	13.2	M41G*
<b>PIR2-024DC-00LD</b>	24	DC	640	19.2	26.4	M41G*
PIR2-110DC-00LD	110	DC	13600	88.0	121.0	M43G*
PIR2-0120C-00LV	12	DC	160	9.6	13.2	M91G**
<b>PIR2-024DC-00LV</b>	24	DC	640	19.2	26.4	M91G**
PIR2-110DC-00LV	110	DC	13600	88.0	121.0	M93G**
<b>PIR2-120AC-00LV</b>	120	AC 50/60Hz	3770	96.0	132.0	M93G**
PIR2-230AC-00LV	230	AC 50/60Hz	16100	184.0	253.0	M93G**

\* Module LD (polarization N) it limits overvoltage on DC coils. Coil energizing indication. M41G on 6/24VDC ; M42G on 24/60VDC ; M43G on 110/230VDC.

\*\* Module LV it limits overvoltage on AC and DC coils. Coil energizing indication. M91G on 6/24VAC ; M92G on 24/60VAC ; M93G on 110/230VAC.

PIR2

### CONNECTION DIAGRAMS

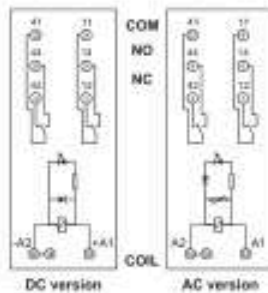

### INTERCONNECTION STRIP

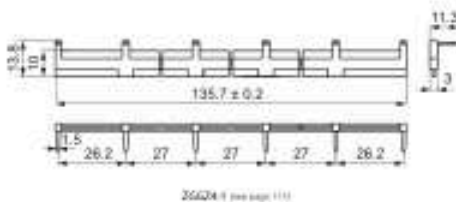

### DIMENSIONS

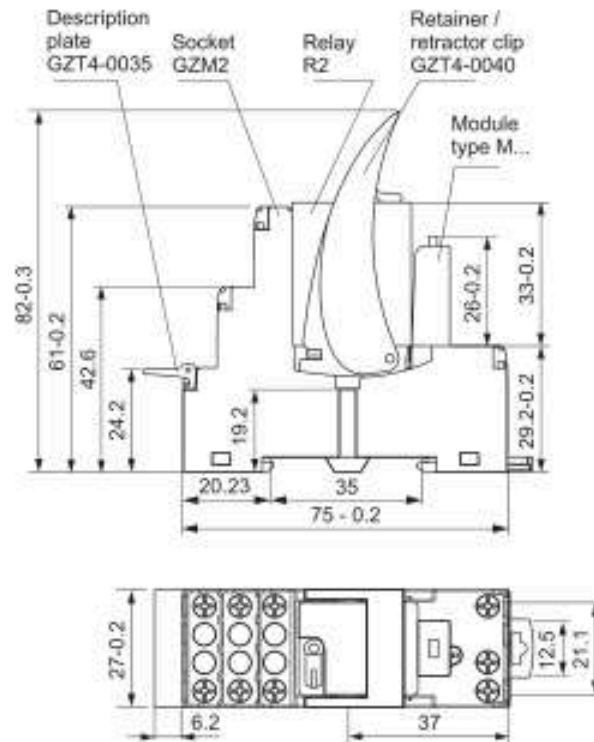

► BOLD - Regular stocked items.

All accessories are included

# PIR3

## Relay Socket Combination

PIR3



Relay: R3 (see page 50 for detailed information)

Socket: GZM3 (see page 56 for detailed information)

### Technical Information

Current .....10 A  
 Voltage.....250V AC / 24V DC  
 Wire Range.....2.5 mm<sup>2</sup> / 24-14 AWG  
 Torque.....0.7 Nm

### PIR3 3PDT AC 50/60Hz & DC coil

Part Number	Coil Voltage (V)	Coil Type	Coil Resistance at 20°C in Ω	Coil Operating Range		Type of Module
				min. (at 20°C)	max. (at 55°C)	
PIR3-012DC-00LD	12	DC	160	9.6	13.2	M41G*
PIR3-024DC-00LD	24	DC	640	19.2	26.4	M41G*
PIR3-110DC-00LD	110	DC	13600	88.0	121.0	M43G*
PIR3-012DC-00LV	12	DC	160	9.6	13.2	M91G**
PIR3-024DC-00LV	24	DC	640	19.2	26.4	M91G**
PIR3-110DC-00LV	110	DC	13600	88.0	121.0	M93G**
PIR3-120AC-00LV	120	AC 50/60Hz	3770	96.0	132.0	M93G**
PIR3-230AC-00LV	230	AC 50/60Hz	16100	184.0	253.0	M93G**

\* Module LD (polarization N) it limits overvoltage on DC coils. Coil energizing indication. M41G on 6/24VDC ; M42G on 24/60VDC ; M43G on 110/230VDC.

\*\* Module LV it limits overvoltage on AC and DC coils. Coil energizing indication. M91G on 6/24VAC ; M92G on 24/60VAC ; M93G on 110/230VAC.

PIR3

### CONNECTION DIAGRAMS

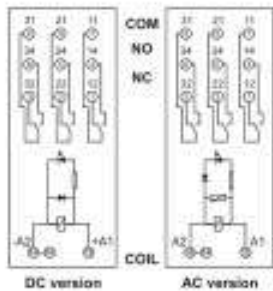

### INTERCONNECTION STRIP

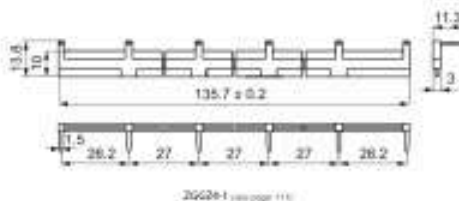

### DIMENSIONS

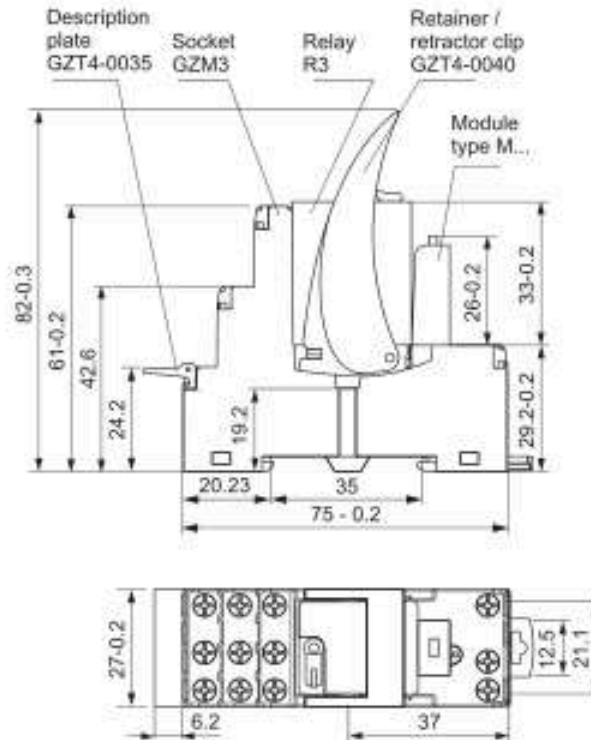

All accessories are included.

# PIR4

## Relay Socket Combination

PIR4



Relay: R4 (see page 50 for detailed information)

Socket: GZM4 (see page 56 for detailed information)

### Technical Information

Current ..... 6 A  
 Voltage..... 250V AC / 24V DC  
 Wire Range..... 2.5 mm<sup>2</sup> / 24-14 AWG  
 Torque..... 0.7 Nm

### PIR4 4PDT AC 50/60Hz & DC coil

Part Number	Coil Voltage (V)	Coil Type	Coil Resistance at 20°C in Ω	Coil Operating Range		Type of Module
				min. (at 20°C)	max. (at 55°C)	
PIR4-012DC-00LD	12	DC	160	9.6	13.2	M41G*
<b>PIR4-024DC-00LD</b>	24	DC	640	19.2	26.4	M41G*
PIR4-110DC-00LD	110	DC	13600	88.0	121.0	M43G*
PIR4-012DC-00LV	12	DC	160	9.6	13.2	M91G**
<b>PIR4-024DC-00LV</b>	24	DC	640	19.2	26.4	M91G**
PIR4-110DC-00LV	110	DC	13600	88.0	121.0	M93G**
<b>PIR4-120AC-00LV</b>	120	AC 50/60Hz	3770	96.0	132.0	M93G**
PIR4-230AC-00LV	230	AC 50/60Hz	16100	184.0	253.0	M93G**

\* Module LD (polarization N) it limits overvoltage on DC coils. Coil energizing indication. M41G on 6/24VDC ; M42G on 24/60VDC ; M43G on 110/230VDC.

\*\* Module LV it limits overvoltage on AC and DC coils. Coil energizing indication. M91G on 6/24VAC ; M92G on 24/60VAC ; M93G on 110/230VAC.

PIR4

### CONNECTION DIAGRAMS

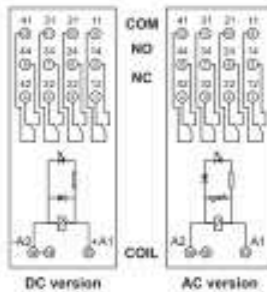

### INTERCONNECTION STRIP

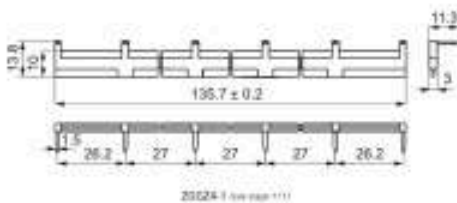

### DIMENSIONS

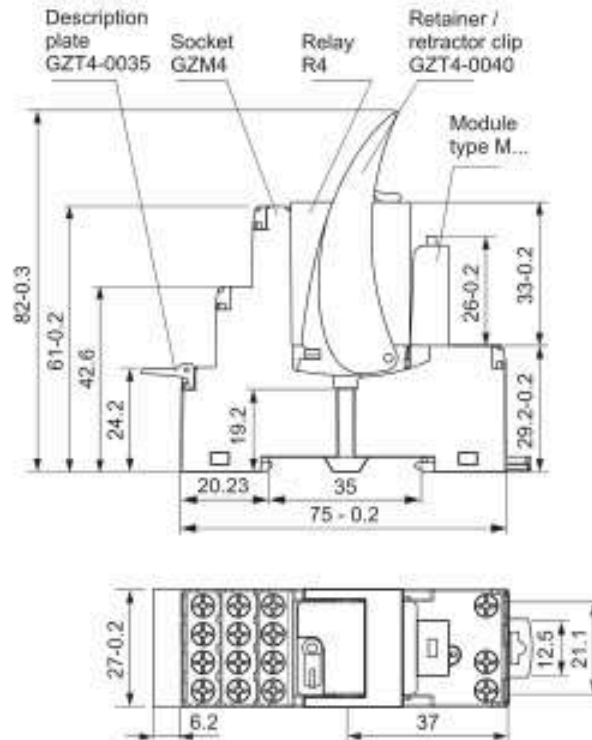

► **BOLD** - Regular stocked items.

All accessories are included

# PIR2M

## Relay Socket Combination

PIR2M



Relay: R2M (see page 58 for detailed information)

Socket: GZ2 (see page 65 for detailed information)

### Technical Information

Current ..... 5 A  
 Voltage..... 250V AC / 24V DC  
 Wire Range..... 2.5 mm<sup>2</sup> / 24-14 AWG  
 Torque..... 0.7 Nm

### PIR2M DPDT AC 50/60Hz & DC coil

Part Number	Coil Voltage (V)	Coil Type	Coil Resistance at 20°C in Ω	Coil Operating Range	
				min. (at 20°C)	max. (at 55°C)
PIR2M-012DC-20	12	DC	188	9.6	13.2
PIR2M-024DC-20	24	DC	750	19.2	26.4
PIR2M-110DC-20	110	DC	13480	88.0	121.0
PIR2M-115AC-20	120	AC 50/60Hz	6390	96.0	132.0
PIR2M-230AC-20	230	AC 50/60Hz	21470	184.0	253.0

PIR2M

### CONNECTION DIAGRAMS

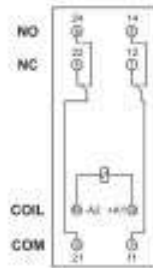

### DIMENSIONS

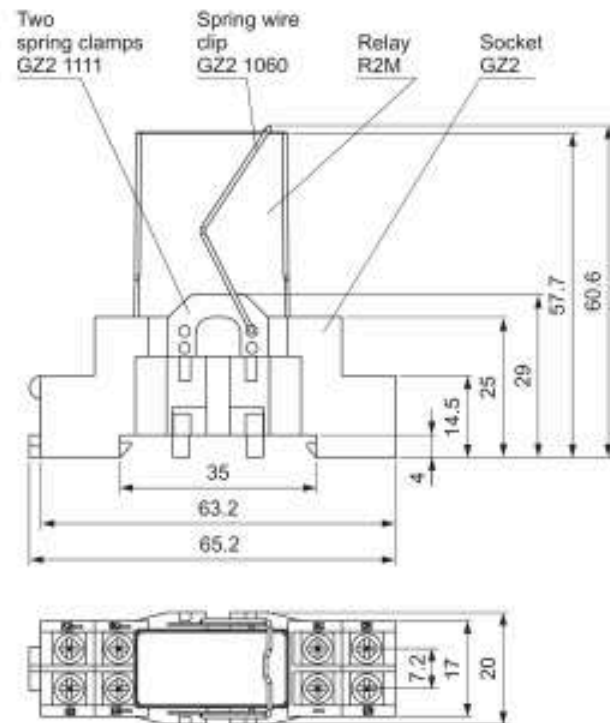

All accessories are included.

# Accessories

## ZGGZ80 - Interconnection Strip



ZGGZ80-1

- Designed for the co-operation with plug-in sockets of miniature relays and with interface relays P184 and P185, which are equipped with screw terminals; sockets and relays are mounted on 35 mm rail mount acc. to PN-EN 60715,
- Bridges common input signals (coil terminals A1 or A2) or output signals - see photo at the top,
- Maximum permissible current is 10 A / 250 V AC,
- Possibility of connection of 8 sockets or relays,
- Colors of strips: ZGGZ80-1 grey

### ZGGZ80-1

#### Plug-in sockets

GZT 80  
GZM 80  
GZT 92  
GZM 92

#### Relays for plugin sockets

RM84, RM85, RM87  
RM84, RM85, RM87  
RM84, RM85, RM87  
RM84, RM85, RM87

#### Relays socket combination

P184-...-M..G (GZT80+RM84)  
P184-...-DOL (GZM80+RM84)  
P185-...-M..G (GZT80+RM85)  
P185-...-DOL (GZM80+RM85)

Interface relay P184 (P185) is offered as a set: plug-in socket GZT80 or GZM80 + miniature relay RM84 (RM85) + signalling / protecting module type M... + retainer / retractor clip GZT80-0040 + description plate GZT80-0035.

## Altech Custom Assemblies

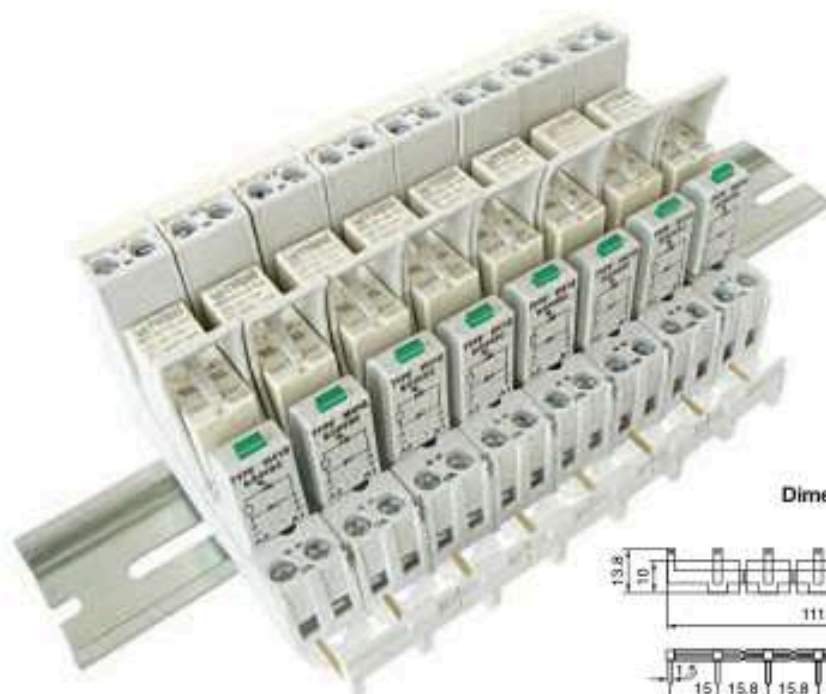

Dimensions

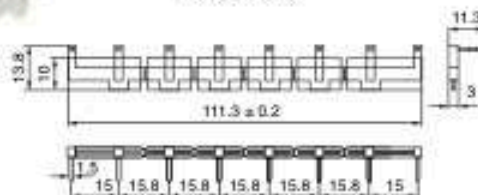

**Altech provides quick turnaround and competitive prices on assemblies.**

For complete assemblies contact Altech.



ZGGZ4-1

- Designed for the co-operation with plug-in sockets of miniature industrial relays and with interface relays PIR2, PIR3 and PIR4, which are equipped with screw terminals; sockets and relays are mounted on 35 mm rail mount acc. to PN-EN 60715.
- Bridges common input signals (coil terminals A1 or A2) or output signals - see photo at the top.
- Maximum permissible current is 10 A / 250 V AC.
- Possibility of connection of 6 sockets or relays.
- Colors of strips: ZGGZ4-1 grey

### ZGGZ4-1

#### Plug-in sockets

GZT2  
GZM2  
GZT3  
GZM3  
GZT4  
GZM4

#### Relays for plugin sockets

R2  
R2  
R3  
R4  
R4

#### Relays socket combination

PIR2-...-00L (GZM2+R2)  
PIR3-...-00L (GZM3+R3)  
PIR4-...-00L (GZM4+R4)

Interface relay PIR2 (PIR3, PIR4) is offered as a set: plug-in socket GZM2 (GZM3, GZM4) + miniature industrial relay R2 (R3, R4) + signalling / protecting module type M... + retainer / retractor clip GZT4-0040 + description plate GZT4-0035.

## Altech Custom Assemblies

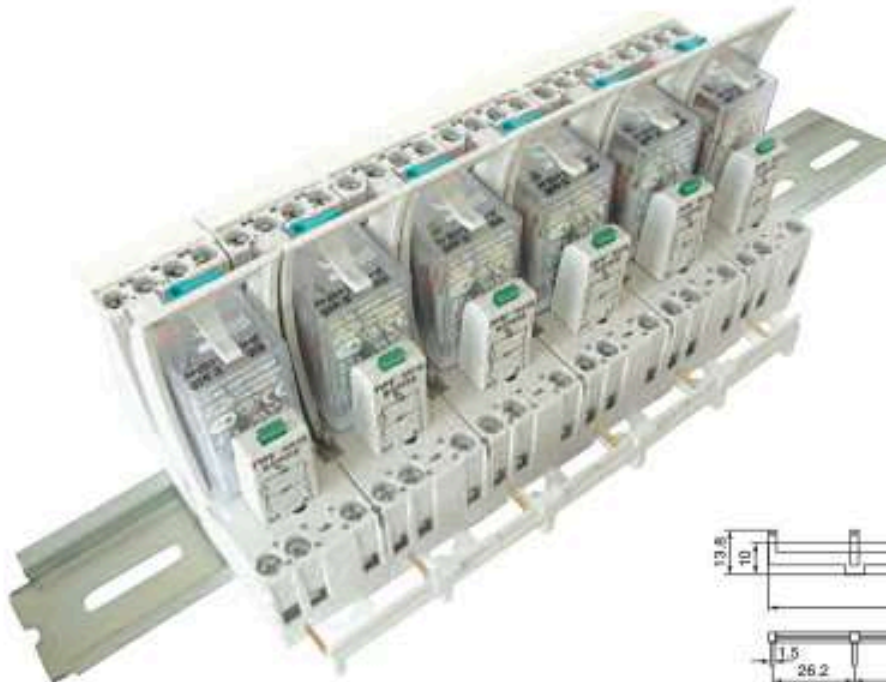

#### Dimensions



**Altech provides quick turnaround and competitive prices on assemblies.**

For complete assemblies contact Altech.

# Accessories For Industrial Relays

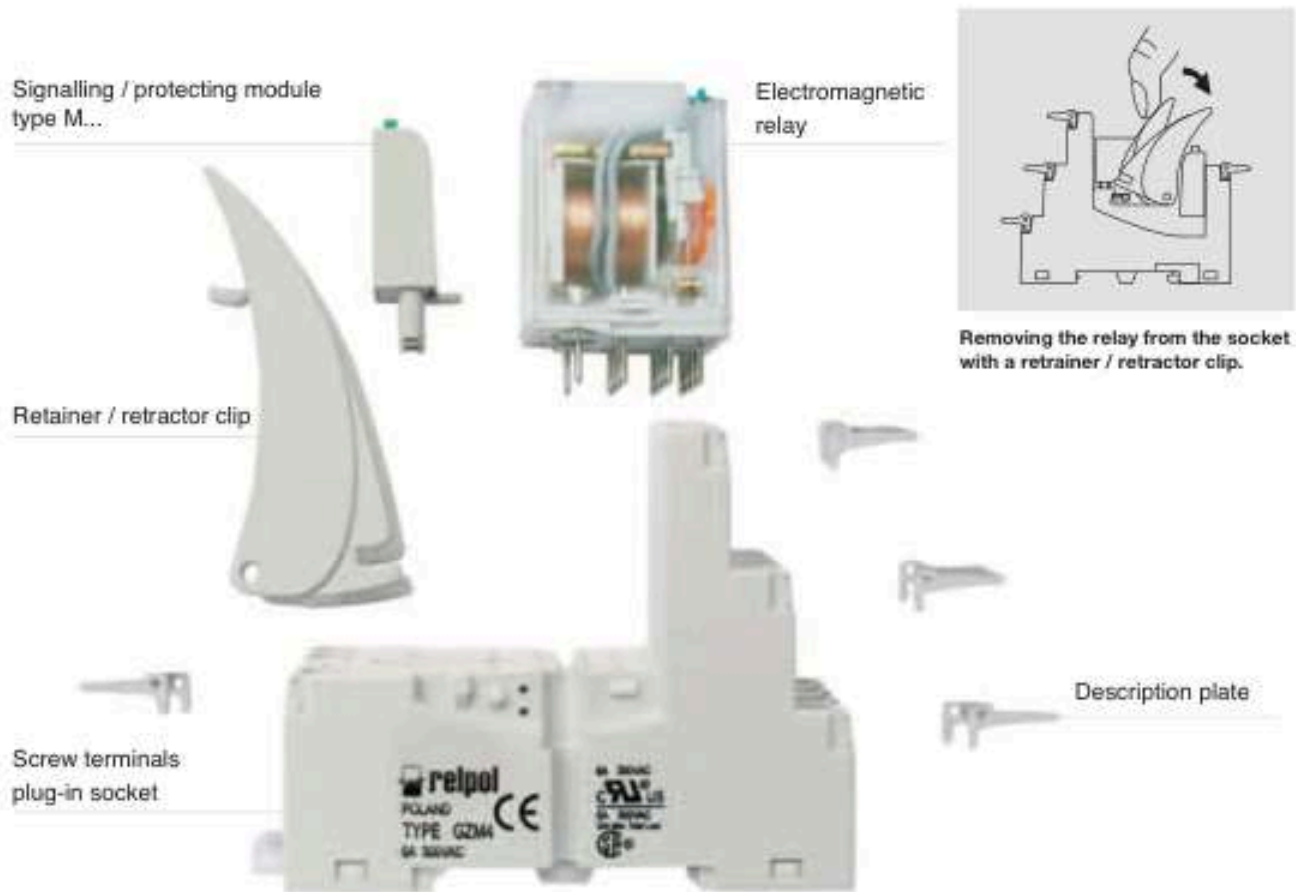

<b>Type of plug-in socket</b>	GZT80, GZT92 GZM80, GZM92	GZT2, GZT3, GZT4 GZM2, GZM3, GZM4
<b>Retainer / retractor clips</b>		
<b>Type</b>	GZT80-0040	GZT4-0040
<b>Color</b>	gray	gray
<b>Description plates</b>		
<b>Type</b>	GZT80-0035	GZT4-0035
<b>color</b>	white	white
<b>For relays</b>	RM84, RM85, RM87	R2, R3, R4
<b>Height of relay</b>	15...16.5 mm	35.6 mm

**For sockets type:** GZT80, GZT92, GZM80, GZM92, GZS80, GZS92, ES 32, GZT2, GZT3, GZT4, GZM2, GZM3, GZM4

Modules are parallel connected with relay coil.  
Polarity P: -A1/+A2. Polarity N: +A1/-A2.



Part Number	Color	Modules	Layout	Layout
M21P		<b>Module D (polarization P)</b> It limits overvoltage on DC coils.		6/230 V DC
M21N		<b>Module D (polarization N)</b> It limits overvoltage on DC coils.		6/230V DC
M31R M32R M33R	red	<b>Module LD (polarization P)</b> It limits overvoltage on DC coils. Coil energizing indication.		6/24 V DC
M31G* M32G M33G	green			24/60 V DC
				110/230V DC
▶ <b>M41G</b> ▶ <b>M42G</b> ▶ <b>M43G</b>	green	<b>Module LD (polarization N)</b> It limits overvoltage on DC coils. Coil energizing indication.		6/24 V DC
				24/60V DC
				110/230V DC
▶ <b>M51</b> ▶ <b>M52</b> ▶ <b>M53</b>		<b>Module RC</b> It protects against EMC disturbance. It limits overvoltage.		6/24V AC 24/60V AC 110/240V AC
M61R M62R M63R M61G* M62G M63G*	red	<b>Module L</b> Coil energizing indication.		6/24V AC/DC
	red			24/60V AC/DC
	red			110/230V AC/DC
	green			6/24V AC/DC
	green			24/60V AC/DC
	green			110/230V AC/DC
M91R M92R M93R ▶ <b>M91G</b> ▶ <b>M92G</b> ▶ <b>M93G</b>	red	<b>Module LV</b> It limits overvoltage on AC and DC coils. Coil energizing indication.		6/24V AC/DC
	red			24/60V AC/DC
	red			110/230V AC/DC
	green			6/24V AC/DC
	green			24/60V AC/DC
	green			110/230V AC/DC
M71 M72 M73		<b>Module V</b> It limits overvoltage on AC and DC coils. No indication.		24V AC
				130V AC
				230V AC
M103		<b>Module R</b> It limits overvoltage on AC coils.		110/230V AC

▶ **BOLD** - Regular stocked items.

# Additional Features for Industrial Relays

## Explantions for Additional Features

Type ●	Description	For industrial relays
<b>W</b>	mechanical indicator	R2, R3, R4, R15 - DPDT, 3PDT
<b>T</b>	lockable front test button, orange colour - AC coils, green colour - DC coils	R2, R3, R4, R15 - DPDT, 3PDT
<b>L</b>	light indicator (LED diode), located inside the relay	R2, R3, R4, RY2, R15 - DPDT, 3PDT, 4PDT RUC, RUC-M
<b>D</b>	surge suppression element (diode) - only for DC coils	R2, R3, R4, RY2, R15 - DPDT, 3PDT, 4PDT
<b>V</b>	surge suppression element (varistor) - only for AC coils	R15 - DPDT, 3PDT
<b>K</b>	test button without block function	R15 - 4PDT RUC

**WT** = mechanical indicator + lockable front test button; basic features of standard industrial relays: R2, R3, R4, R15 - DPDT, 3PDT - for plug-in sockets. Detailed information for individual relays: see "Ordering codes - Additional features".

### Available combinations:

WT, WTL, WTD, WTLD - in relays R2, R3, R4 for plug-in sockets

L, D, LD - in relays RY2 for plug-in sockets

WT, WTL, WTD, WTLD, WTV, WTLV - in relays R15 - DPDT, 3PDT for plug-in sockets

K, L, D, KL, KD, LD, KLD - in relays R15 - 4PDT for plug-in sockets

K, L, KL - in relays RUC

L - in relays RUC-M

## TEST BUTTONS Type T

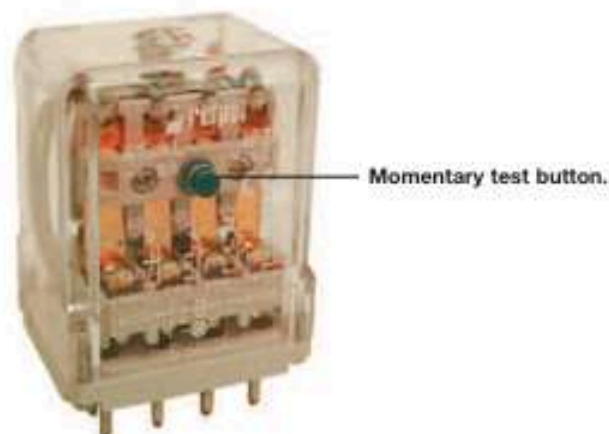

# Test Buttons (no latching) and Plugs

**Test buttons** are available for R2...WT, R3...WT, R4...WT, R15...WT DPDT, R15...WT 3PDT, relays - for applications that do not require permanent contact latching. By manual operation (pressing the button, see figures 1A and 1B) relay contacts can get switched for as long time as long the button is pressed. Contacts return to initial position as soon as pressure is released from the button. Those operations can be done while the coil is deenergized. Button R4P-0001 or R15-M404 can be easily inserted by the Customer after removal of button type T (see figure 1B).

Button type T can be removed with screwdriver as shown in figure 2.

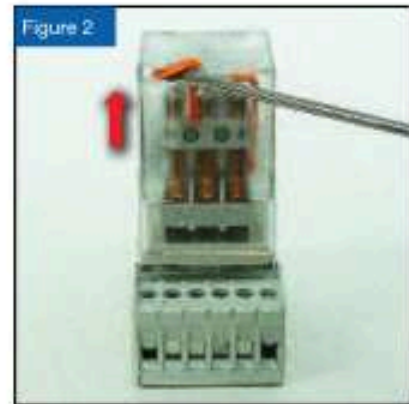
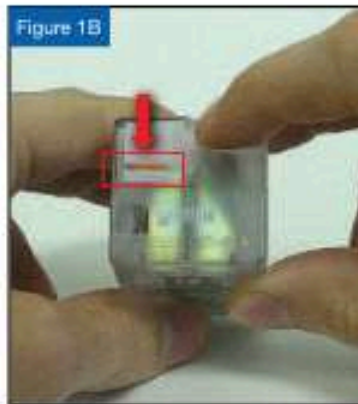
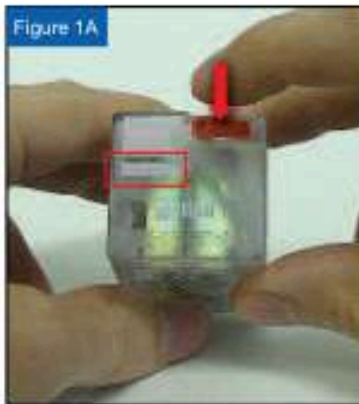

**Dimensions - test button R4P-0001**  
for relays R2...WT, R3...WT, R4...WT

Types of buttons:  
**R4P-0001-A** - orange colour (AC coils)  
**R4P-0001-D** - green colour (DC coils)

**Dimensions - test button R15-M404**  
for relays R15...WT - DPDT, 3PDT

Types of buttons:  
**R15-M404-A** - orange colour (AC coils)  
**R15-M404-D** - green colour (DC coils)

Plugs R4W-0003 or R15-M203 can substitute button type T if manual operation (latching and testing) is not allowed. Changing button type T for plug can be done by Customer themselves in the same way as changing button type T for button (no latching).

**Dimensions - plug R4W-0003**  
for relays R2...WT, R3...WT, R4...WT

Types of plugs:  
**R4W-0003-A** - orange colour (AC coils)  
**R4W-0003-D** - green colour (DC coils)

**Dimensions - plug R15-M203**  
for relays R15...WT - DPDT, 3PDT

Types of plugs:  
**R15-M203-A** - orange colour (AC coils)  
**R15-M203-D** - green colour (DC coils)

# CUSTOM INTERFACE MODULES

If your design or application requires more functionality or features than our standard product, Altech offers complete engineering, prototype and production services for custom modules.

Our staff has the ability to take your design or requirements and manufacture your custom module. Custom module production generally includes engineering, PCB layout and prototypes, packaged in Altech extrusions for mounting on panels or DIN Rail. In many industrial control systems, customized designs are the solution for many problems.

Altech provides a quick turnaround and competitive solution to your problem. Altech provides the following benefits to your company:

#### Application Assistance

- Modify a standard product
- Help define a new product

#### Engineering Capability

- Use of latest CAD system
- PCB layouts completed promptly
- Prototypes available two weeks after PCB layout approval

#### Manufacturing Capability

- Complete in-house manufacturing
- ISO 9001 Certified

#### Minimum Quantities

- 25 piece minimum for custom quotes
- Quotation provided at no cost

#### Altech Benefits

- Fast turnaround due to in-house capability
- Highly competitive in-house manufacturing
- Use of Altech components (blocks, extrusions, connectors)

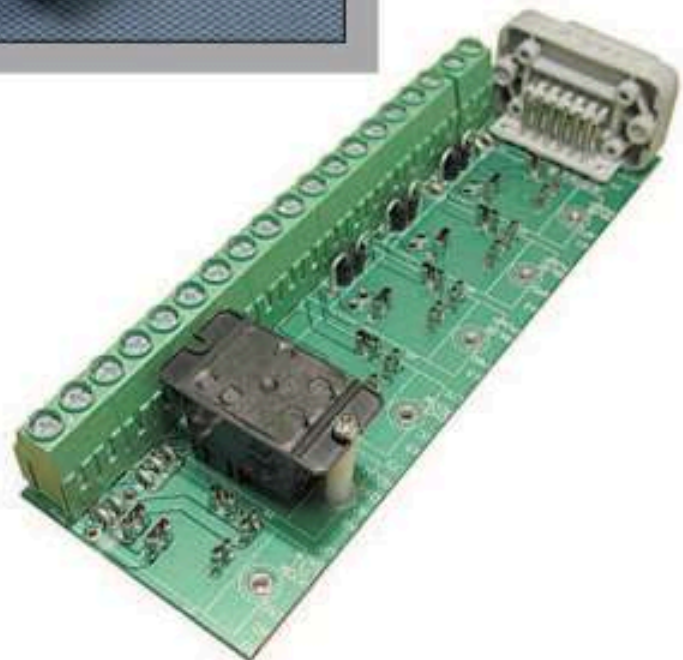
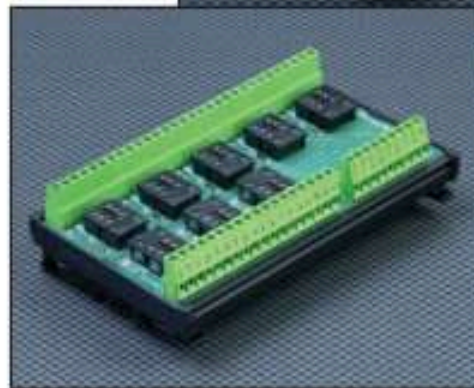

- Most competitive in industry
- Made to your specifications
- Large inventory of components
- Variety of colors available
- Shipped in 3-4 weeks

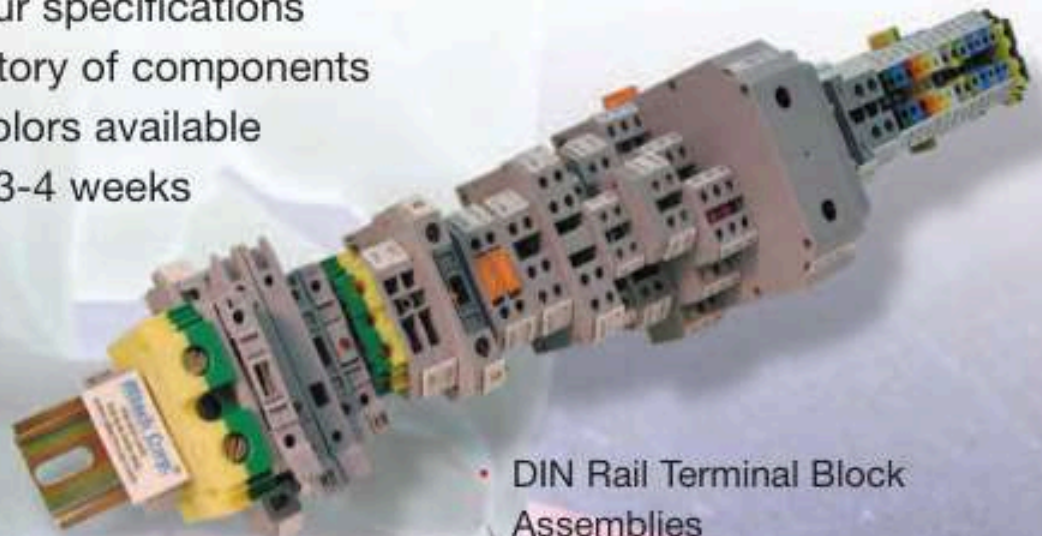

- DIN Rail Terminal Block Assemblies
- Push Button Control Stations
- Relay Assemblies
- Custom Interface Assemblies
- Enclosure Customization
- Imprinting
- Foot Switch Customization
- New Product Development
- Other Value Added Services.

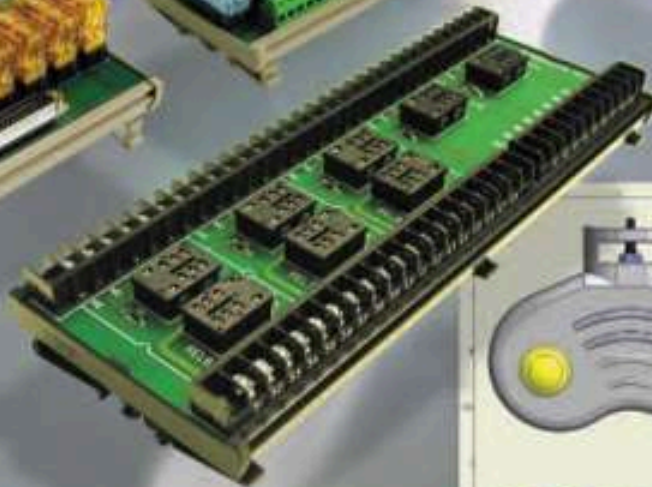
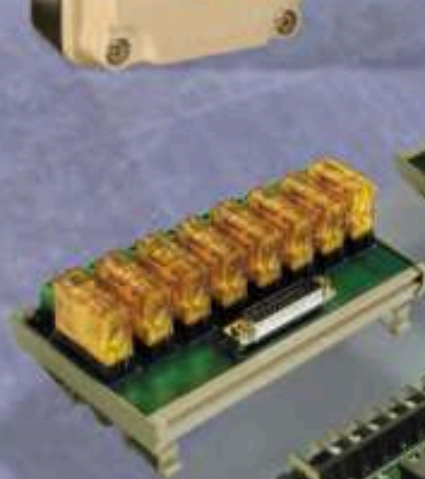

# INDEX

Part No.	Pg.	Part No.	Pg.	Part No.	Pg.	Part No.	Pg.
5492.2	20	8837.2	12	8935.3	16	8995.5	18
5492.5	20	8838.2	12	8935.5	16	8999.2	18
5494.2	20	8839.2	12	8935.6	16	8999.5	18
5494.5	20	8840.2	12	8938.2	14	125 (4.92)	30
5502.2	20	8842.2	11	8939.2	14	125 (4.92)	30
5502.5	20	8842.3	11	8940.2	16	125 (4.92)	30
5506.2	20	8842.4	11	8940.3	16	125 (4.92)	30
5506.5	20	8850.2	11	8940.5	16	156.OA01.1222C	34
5508.2	20	8850.3	11	8940.6	16	156.OA01.1231C	34
5508.5	20	8850.4	11	8941.2	16	156.OA01.2422C	34
5514.2	20	8861.0	44	8941.3	16	156.OA01.2431C	34
5514.3	20	8905.2	24	8941.5	16	156.OA11.1222C	32
5514.5	20	8905.3	26	8941.6	16	156.OA11.1231C	32
5514.6	20	8906.2	24	8942.2	16	156.OA11.2422C	32
5700.2	13	8906.3	26	8942.3	16	156.OA11.2431C	32
5701.2	13	8907.2	24	8942.5	16	156.OA12.1224C	36
5702.2	11	8907.3	26	8942.6	16	156.OA12.1224C	36
5702.3	11	8908.2	24	8943.2	16	156.OA12.1233C	36
5702.4	11	8908.3	26	8943.3	16	156.OA12.1233C	36
5703.2	11	8909.2	24	8943.5	16	156.OA12.1242C	36
5703.3	11	8909.3	26	8943.6	16	156.OA12.1242C	36
5703.4	11	8910.2	24	8944.2	16	156.OA12.2424C	36
5704.2	11	8910.3	26	8944.5	16	156.OA12.2424C	36
5704.3	11	8911.2	24	8945.2	18	156.OA12.2433C	36
5704.4	11	8911.3	26	8945.5	18	156.OA12.2433C	36
5705.2	11	8912.2	20	8946.2	16	156.OA12.2442C	36
5705.3	11	8912.3	20	8946.5	16	156.OA12.2442C	36
5705.4	11	8912.5	20	8948.2	16	156.OA03.1226C	40
5706.2	11	8912.6	20	8948.5	16	156.OA03.1235C	40
5706.3	11	8913.3	20	8949.3	18	156.OA03.1244C	40
5706.4	11	8913.6	20	8949.6	18	156.OA03.1253C	40
5707.2	11	8914.2	20	8951.2	18	156.OA03.1262C	40
5707.3	11	8914.5	20	8951.3	18	156.OA03.1271C	40
5707.4	11	8921.2	20	8951.5	18	156.OA03.2426C	40
5718.2	15	8921.5	20	8951.6	18	156.OA03.2435C	40
5718.3	15	8923.2	22	8953.2	18	156.OA03.2444C	40
5719.2	15	8923.3	22	8953.3	18	156.OA03.2453C	40
5719.3	15	8923.5	22	8953.5	18	156.OA03.2462C	40
5720.2	7	8923.6	22	8953.6	18	156.OA03.2471C	40
5721.2	7	8924.2	22	8954.2	18	248 (9.76)	30
5722.2	7	8924.4	22	8954.3	18	248 (9.76)	30
5723.2	7	8924.5	22	8954.5	18	248 (9.76)	30
5724.2	7	8924.6	22	8954.6	18	248 (9.76)	30
5725.2	7	8925.2	22	8955.2	18	256.OA01.1222C	34
5726.2	7	8925.3	22	8955.3	18	256.OA01.1231C	34
5727.2	7	8925.5	22	8955.5	18	256.OA01.2422C	34
5728.2	7	8925.6	22	8955.6	18	256.OA01.2431C	34
5729.2	7	8926.2	22	8956.2	18	256.OA11.1222C	32
5740.2	8	8926.3	22	8956.3	18	256.OA11.1231C	32
5741.2	8	8926.5	22	8956.5	18	256.OA11.2422C	32
5742.2	8	8926.6	22	8956.6	18	256.OA11.2431C	32
5743.2	8	8927.2	22	8957.2	18	256.OA12.1224C	36
5744.2	8	8927.3	22	8957.3	18	256.OA12.1224C	36
5745.2	9	8927.5	22	8957.5	18	256.OA12.1233C	36
5746.2	9	8927.6	22	8957.6	18	256.OA12.1233C	36
5747.2	9	8928.2	22	8959.0	44	256.OA12.1242C	36
5748.2	9	8928.3	22	8959.2	18	256.OA12.1242C	36
5749.2	9	8928.5	22	8959.3	18	256.OA12.2424C	36
5800.2	24	8928.6	22	8959.5	18	256.OA12.2424C	36
5800.3	26	8929.2	16	8959.6	18	256.OA12.2433C	36
5801.2	24	8929.3	16	8963.2	18	256.OA12.2433C	36
5801.3	26	8929.5	16	8963.5	18	256.OA12.2442C	36
5802.2	24	8929.6	16	8972.2	18	256.OA12.2442C	36
5802.3	26	8931.2	16	8972.5	18	456.OA01.1222C	34
5803.2	24	8931.3	16	8973.2	11	456.OA01.1231C	34
5803.3	26	8931.5	16	8973.3	11	456.OA01.2422C	34
5804.2	24	8931.6	16	8973.4	11	456.OA01.2431C	34
5804.3	26	8932.2	16	8974.2	11	456.OA11.1222C	32
5805.2	24	8932.5	16	8974.3	11	456.OA11.1231C	32
5805.3	26	8933.2	16	8974.4	11	456.OA11.2422C	32
5806.2	24	8933.3	16	8975.2	11	456.OA11.2431C	32
5806.3	26	8933.5	16	8975.3	11	458.OA12.1224C	36
8835.2	12	8933.6	16	8975.4	11	458.OA12.1224C	36
8836.2	12	8935.2	16	8995.2	18	456.OA12.1233C	36

**BOLD** - Regular stocked items.

Part No.	Pg.	Part No.	Pg.	Part No.	Pg.	Part No.	Pg.
456.0A12.1233C	38	8907.3/S	26	8931.6/S	16	8955.2S	28
456.0A12.1242C	36	8908.2/S	24	8932.2/S	16	8955.3/S	18
456.0A12.1242C	38	8908.3/S	26	8932.5/S	16	8955.3C	28
456.0A12.2424C	36	8909.2/S	24	8933.2/S	16	8955.3N	28
456.0A12.2424C	38	8909.3/S	26	8933.3/S	16	8955.3S	28
456.0A12.2433C	36	8910.2/S	24	8933.5/S	16	8955.5/S	18
456.0A12.2433C	38	8910.3/S	26	8933.6/S	16	8955.6/S	18
456.0A12.2442C	36	8911.2/S	24	8935.2/S	16	8956.0	44
456.0A12.2442C	38	8911.3/S	26	8935.3/S	16	8956.0/B	42
5492.2/S	20	8912.2/S	20	8935.5/S	16	8956.0/E	42
5492.5/S	20	8912.3/S	20	8935.6/S	16	8956.0/G	42
5494.2/S	20	8912.5/S	20	8937.2	14	8956.2/S	18
5494.5/S	20	8912.6/S	20	8937.2/S	14	8956.2C	28
5502.2/S	20	8913.3/S	20	8938.2/S	14	8956.2N	28
5502.5/S	20	8913.6/S	20	8939.2/S	14	8956.2S	28
5506.2/S	20	8914.2/S	20	8940.2/S	16	8956.3/S	18
5506.5/S	20	8914.5/S	20	8940.3/S	16	8956.3C	28
5508.2/S	20	8921.2/S	20	8940.5/S	16	8956.3N	28
5508.5/S	20	8921.5/S	20	8940.6/S	16	8956.3S	28
5514.2/S	20	8923.2/S	22	8941.2/S	16	8956.5/S	18
5514.3/S	20	8923.2C	30	8941.3/S	16	8956.6/S	18
5514.5/S	20	8923.2N	30	8941.5/S	16	8957.0/B	42
5514.6/S	20	8923.2S	30	8941.6/S	16	8957.0/E	42
5700.2/S	13	8923.3/S	22	8942.2/S	16	8957.0/G	42
5701.2/S	13	8923.3C	30	8942.3/S	16	8957.2/S	18
5718.2/S	15	8923.3N	30	8942.5/S	16	8957.3/S	18
5718.3/S	15	8923.3S	30	8942.6/S	16	8957.5/S	18
5719.2/S	15	8923.5/S	22	8943.2/S	16	8957.6/S	18
5719.3/S	15	8923.6/S	22	8943.3/S	16	8959.2/S	18
5720.2/S	7	8924.2/S	22	8943.5/S	16	8959.3/S	18
5721.2/S	7	8924.2C	30	8943.6/S	16	8959.5/S	18
5722.2/S	7	8924.2N	30	8944.2/S	16	8959.6/S	18
5723.2/S	7	8924.2S	30	8944.5/S	16	8963.2/S	18
5724.2/S	7	8924.4/S	22	8945.2/S	18	8963.2C	28
5725.2/S	7	8924.4C	30	8945.5/S	18	8963.2N	28
5726.2/S	7	8924.4N	30	8946.2/S	16	8963.2S	28
5727.2/S	7	8924.4S	30	8946.5/S	16	8963.5/S	18
5728.2/S	7	8924.5/S	22	8948.2/S	16	8971.2	11
5729.2/S	7	8924.6/S	22	8948.5/S	16	8971.3	11
5740.2/S	8	8925.2/S	22	8949.2C	28	8971.4	11
5741.2/S	8	8925.3/S	22	8949.2N	28	8972.2/S	18
5742.2/S	8	8925.5/S	22	8949.2S	28	8972.2C	28
5743.2/S	8	8925.6/S	22	8949.3/S	18	8972.2N	28
5744.2/S	8	8926.2/S	22	8949.3C	28	8972.2S	28
5745.2/S	9	8926.2C	30	8949.3N	28	8972.5/S	18
5746.2/S	9	8926.2N	30	8949.3S	28	8995.2/S	18
5747.2/S	9	8926.2S	30	8949.6/S	18	8995.5/S	18
5748.2/S	9	8926.3/S	22	8951.2/S	18	8999.2/S	18
5749.2/S	9	8926.3C	30	8951.2C	28	8999.5/S	18
5800.2/S	24	8926.3N	30	8951.2N	28	EPDP1	46
5800.3/S	26	8926.3S	30	8951.2S	28	EPDP1/G	46
5801.2/S	24	8926.5/S	22	8951.3/S	18	EPDP2	47
5801.3/S	26	8926.6/S	22	8951.3C	28	EPDP2/G	47
5802.2/S	24	8927.2/S	22	8951.3N	28	EPDR1	46
5802.3/S	26	8927.2C	30	8951.3S	28	EPDR1/G	46
5803.2/S	24	8927.2N	30	8951.5/S	18	EPDR2	47
5803.3/S	26	8927.2S	30	8951.6/S	18	EPDR2/G	47
5804.2/S	24	8927.3/S	22	8953.2/S	18	EPS	46
5804.3/S	26	8927.3C	30	8953.3/S	18	EPS	47
5805.2/S	24	8927.3N	30	8953.5/S	18	GD35	83
5805.3/S	26	8927.3S	30	8953.6/S	18	GD50	83
5806.2/S	24	8927.5/S	22	8954.0/B	42	GUC11	65
5806.3/S	26	8927.6/S	22	8954.0/E	42	GZ14U	70
8835.2/S	12	8928.2/S	22	8954.0/G	42	GZ2	85
8836.2/S	12	8928.3/S	22	8954.2/S	18	GZM 80	110
8837.2/S	12	8928.5/S	22	8954.3/S	18	GZM 92	110
8838.2/S	12	8928.6/S	22	8954.5/S	18	GZM2	55
8839.2/S	12	8929.2/S	16	8954.6/S	18	GZM2	111
8840.2/S	12	8929.3/S	16	8955.0/B	42	GZM3	56
8905.2/S	24	8929.5/S	16	8955.0/E	42	GZM3	111
8905.3/S	26	8929.6/S	16	8955.0/G	42	GZM4	56
8906.2/S	24	8931.2/S	16	8955.2/S	18	GZM4	111
8906.3/S	26	8931.3/S	16	8955.2C	28	GZM80	81
8907.2/S	24	8931.5/S	16	8955.2N	28	GZM92	82

**BOLD** - Regular stocked items.

# INDEX

Part No.	Pg.	Part No.	Pg.	Part No.	Pg.	Part No.	Pg.
GZMB2	57	PI84-012DC-00LV	104	<b>PIR6W-1PS-24VAC/DC-C</b>	97	PIR6WB-1PS-60VDC-C	101
GZMB4	57	PI84-024DC-00LD	104	<b>PIR6W-1PS-24VAC/DC-O</b>	97	PIR6WB-1PS-60VDC-O	101
GZMB90	83	PI84-024DC-00LV	104	<b>PIR6W-1PS-24VAC/DC-R</b>	96	PIR6WB-1PS-60VDC-R	100
GZP11	89	PI84-110DC-00LD	104	<b>PIR6W-1PS-24VAC/DC-R01</b>	96	PIR6WB-1PS-60VDC-R01	100
GZP8	89	PI84-110DC-00LV	104	<b>PIR6W-1PS-24VAC/DC-T</b>	97	PIR6WB-1PS-60VDC-T	101
GZT 80	110	PI84-110DC-M43G	104	PIR6W-1PS-24VDC-C	97	PIR6WB-1PS-60VDC-C	101
GZT 92	110	PI84-110DC-M93G	104	PIR6W-1PS-24VDC-O	97	PIR6WB-1PS-60VDC-O	101
GZT2	55	PI84-120AC-00LV	104	<b>PIR6W-1PS-24VDC-R</b>	96	PIR6WB-1PS-60VDC-R	100
GZT2	111	<b>PI84-120AC-M93G</b>	104	PIR6W-1PS-24VDC-R01	96	PIR6WB-1PS-60VDC-R01	100
GZT3	55	PI84-120C-M41G	104	PIR6W-1PS-24VDC-T	97	PIR6WB-1PS-60VDC-T	101
GZT3	111	PI84-120C-M91G	104	PIR6W-1PS-36VDC-C	97	PZ11	70
GZT4	56	PI84-230AC-00LV	104	PIR6W-1PS-36VDC-O	97	PZ8	89
GZT4	111	PI84-230AC-M93G	104	PIR6W-1PS-36VDC-R	96	R15-1014-23-1012	88
GZT80	81	<b>PI84-24DC-M41G</b>	104	PIR6W-1PS-36VDC-R01	96	R15-1014-23-1012-D	88
GZT92	82	<b>PI84-24DC-M91G</b>	104	PIR6W-1PS-36VDC-T	97	R15-1014-23-1012-K	88
GZY2G	85	PI85-012DC-00LD	105	PIR6W-1PS-42VAC/DC-C	97	R15-1014-23-1012-L	88
M103	113	PI85-012DC-00LV	105	PIR6W-1PS-42VAC/DC-O	97	R15-1014-23-1024	88
M21N	113	PI85-024DC-00LD	105	PIR6W-1PS-42VAC/DC-R	96	R15-1014-23-1024-D	88
M21P	113	PI85-024DC-00LV	105	PIR6W-1PS-42VAC/DC-R01	96	R15-1014-23-1024-K	88
M31G*	113	PI85-110DC-00LD	105	PIR6W-1PS-42VAC/DC-T	97	<b>R15-1014-23-1024-L</b>	88
M31R	113	PI85-110DC-00LV	105	PIR6W-1PS-48VDC-C	97	R15-1014-23-1110	88
M32G	113	PI85-110DC-M43G	105	PIR6W-1PS-48VDC-O	97	R15-1014-23-1110-D	88
M32R	113	PI85-110DC-M93G	105	PIR6W-1PS-48VDC-R	96	R15-1014-23-1110-K	88
M33G	113	PI85-120AC-00LV	105	PIR6W-1PS-48VDC-R01	96	R15-1014-23-1110-L	88
M33R	113	<b>PI85-120AC-M93G</b>	105	PIR6W-1PS-48VDC-T	97	R15-1014-23-3024	88
M41G	113	PI85-120C-M41G	105	PIR6W-1PS-60VDC-C	97	R15-1014-23-3024-D	88
M42G	113	PI85-120C-M91G	105	PIR6W-1PS-60VDC-O	97	R15-1014-23-3024-K	88
M43G	113	PI85-230AC-00LV	105	PIR6W-1PS-60VDC-R	96	R15-1014-23-3024-L	88
M51	113	PI85-230AC-M93G	105	PIR6W-1PS-60VDC-R01	96	R15-1014-23-3120	88
M52	113	<b>PI85-24DC-M41G</b>	105	PIR6W-1PS-60VDC-T	97	R15-1014-23-3120-D	88
M53	113	<b>PI85-24DC-M91G</b>	105	PIR6W-1PS-6VDC-C	97	R15-1014-23-3120-K	88
M61G*	113	PIR2-012DC-00LD	106	PIR6W-1PS-6VDC-O	97	R15-1014-23-3120-L	88
M61R	113	PIR2-012DC-00LV	106	PIR6W-1PS-6VDC-R	96	R15-1014-23-3230	88
M62G	113	<b>PIR2-024DC-00LD</b>	106	PIR6W-1PS-6VDC-R01	96	R15-1014-23-3230-D	88
M62R	113	<b>PIR2-024DC-00LV</b>	106	PIR6W-1PS-6VDC-T	97	R15-1014-23-3230-K	88
M63G*	113	PIR2-110DC-00LD	106	PIR6WB-1PS-115VAC/DC-C	101	R15-1014-23-3230-L	88
M63R	113	PIR2-110DC-00LV	106	PIR6WB-1PS-115VAC/DC-O	101	R15-1014-23-6120	88
M71	113	<b>PIR2-120AC-00LV</b>	106	<b>PIR6WB-1PS-115VAC/DC-R</b>	100	R15-1014-23-6120-D	88
M72	113	PIR2-230AC-00LV	106	PIR6WB-1PS-115VAC/DC-R01	100	R15-1014-23-6120-K	88
M73	113	PIR2M-012DC-20	109	PIR6WB-1PS-115VAC/DC-T	101	<b>R15-1014-23-6120-L</b>	88
M91G	113	PIR2M-024DC-20	109	PIR6WB-1PS-12VDC-C	101	R15-1014-23-6230	88
M91R	113	PIR2M-110DC-20	109	PIR6WB-1PS-12VDC-O	101	R15-1014-23-6230-D	88
M92G	113	PIR2M-115AC-20	109	PIR6WB-1PS-12VDC-R	100	R15-1014-23-6230-K	88
M92R	113	PIR2M-230AC-20	109	PIR6WB-1PS-12VDC-R01	100	R15-1014-23-6230-L	88
M93G	113	PIR3-012DC-00LD	107	PIR6WB-1PS-12VDC-T	101	<b>R15-2012-23-1012</b>	88
M93R	113	PIR3-012DC-00LV	107	PIR6WB-1PS-230VAC/DC-C	101	R15-2012-23-1012-WT	88
MT2	46	PIR3-024DC-00LD	107	PIR6WB-1PS-230VAC/DC-O	101	R15-2012-23-1012-WTL	88
MT2	47	PIR3-024DC-00LV	107	PIR6WB-1PS-230VAC/DC-R	100	<b>R15-2012-23-1024</b>	88
MTGF1	46	PIR3-110DC-00LD	107	PIR6WB-1PS-230VAC/DC-R01	100	R15-2012-23-1024-WT	88
MTGF1/G	46	PIR3-110DC-00LV	107	<b>PIR6WB-1PS-24VAC/DC-C</b>	101	<b>R15-2012-23-1024-WTL</b>	88
MTGF2	47	PIR3-120AC-00LV	107	<b>PIR6WB-1PS-24VAC/DC-O</b>	101	R15-2012-23-1110	88
MTGF2/G	47	PIR3-230AC-00LV	107	<b>PIR6WB-1PS-24VAC/DC-R</b>	100	R15-2012-23-1110-WT	88
MTGTK1	46	PIR4-012DC-00LD	108	<b>PIR6WB-1PS-24VAC/DC-R01</b>	100	R15-2012-23-1110-WTL	88
MTGTK1/1M	46	PIR4-012DC-00LV	108	<b>PIR6WB-1PS-24VAC/DC-T</b>	101	<b>R15-2012-23-5024</b>	88
MTGTK1/1M/G	46	<b>PIR4-024DC-00LD</b>	108	PIR6WB-1PS-24VDC-C	101	R15-2012-23-5024-WT	88
MTGTK1/G	46	<b>PIR4-024DC-00LV</b>	108	PIR6WB-1PS-24VDC-O	101	R15-2012-23-5024-WTL	88
MTGTK2	47	PIR4-110DC-00LD	108	<b>PIR6WB-1PS-24VDC-R</b>	100	<b>R15-2012-23-5120</b>	88
MTGTK2/1M	47	PIR4-110DC-00LV	108	PIR6WB-1PS-24VDC-R01	100	R15-2012-23-5120-WT	88
MTGTK2/1M/G	47	<b>PIR4-120AC-00LV</b>	108	PIR6WB-1PS-24VDC-T	101	<b>R15-2012-23-5120-WTL</b>	88
MTGTK2/G	47	PIR4-230AC-00LV	108	PIR6WB-1PS-36VDC-C	101	<b>R15-2012-23-5230</b>	88
<b>PI6-1P-115VAC/DC</b>	91	PIR6W-1PS-115VAC/DC-C	97	PIR6WB-1PS-36VDC-O	101	R15-2012-23-5230-WT	88
PI6-1P-12VDC	91	PIR6W-1PS-115VAC/DC-O	97	PIR6WB-1PS-36VDC-R	100	R15-2012-23-5230-WTL	88
PI6-1P-230VAC/DC	91	<b>PIR6W-1PS-115VAC/DC-R</b>	96	PIR6WB-1PS-36VDC-R01	100	<b>R15-2013-23-1012</b>	88
<b>PI6-1P-24VAC/DC</b>	91	PIR6W-1PS-115VAC/DC-R01	96	PIR6WB-1PS-36VDC-T	101	R15-2013-23-1012-WT	88
PI6-1P-36VDC	91	PIR6W-1PS-115VAC/DC-T	97	PIR6WB-1PS-42VAC/DC-C	101	R15-2013-23-1012-WTL	88
PI6-1P-42VAC/DC	91	PIR6W-1PS-12VDC-C	97	PIR6WB-1PS-42VAC/DC-O	101	<b>R15-2013-23-1024</b>	88
PI6-1T-230VAC/DC	92	PIR6W-1PS-12VDC-O	97	PIR6WB-1PS-42VAC/DC-R	100	R15-2013-23-1024-WT	88
PI6-1T-24VAC/DC	92	PIR6W-1PS-12VDC-R	96	PIR6WB-1PS-42VAC/DC-R01	100	<b>R15-2013-23-1024-WTL</b>	88
<b>PI6-1T-5...32VDC</b>	92	PIR6W-1PS-12VDC-R01	96	PIR6WB-1PS-42VAC/DC-T	101	R15-2013-23-1110	88
PI6-OC-230VAC/DC	93	PIR6W-1PS-12VDC-T	97	PIR6WB-1PS-48VDC-C	101	R15-2013-23-1110-WT	88
PI6-OC-24VAC/DC	93	PIR6W-1PS-230VAC/DC-C	97	PIR6WB-1PS-48VDC-O	101	R15-2013-23-1110-WTL	88
<b>PI6-OC-5...32VDC</b>	93	PIR6W-1PS-230VAC/DC-O	97	PIR6WB-1PS-48VDC-R	100	<b>R15-2013-23-5024</b>	88
PI84-012DC-00LD	104	PIR6W-1PS-230VAC/DC-R	96	PIR6WB-1PS-48VDC-R01	100	R15-2013-23-5024-WT	88
		PIR6W-1PS-230VAC/DC-R01	96	PIR6WB-1PS-48VDC-T	101	R15-2013-23-5024-WTL	88

**BOLD** - Regular stocked items.

Part No.	Pg.	Part No.	Pg.	Part No.	Pg.	Part No.	Pg.
<b>R15-2013-23-5120</b>	68	RM50-3021-85-1018	75	RUC-2012-26-5230	62	RUC-2052-26-1110-KL	64
R15-2013-23-5120-WT	68	RM50-3021-85-1024	75	RUC-2012-26-5230-K	62	RUC-2052-26-1110-L	64
<b>R15-2013-23-5120-WTL</b>	68	RM50-3021-85-1048	75	<b>RUC-2012-26-5230-KL</b>	62	RUC-2052-26-5120	64
<b>R15-2013-23-5230</b>	68	<b>RM699BV-3011-85-1005</b>	88	RUC-2012-26-5230-L	62	RUC-2052-26-5120-K	64
R15-2013-23-5230-WT	68	<b>RM699BV-3011-85-1012</b>	88	<b>RUC-2013-26-1012</b>	63	RUC-2052-26-5120-KL	64
R15-2013-23-5230-WTL	68	<b>RM699BV-3011-85-1024</b>	88	RUC-2013-26-1012-K	63	RUC-2052-26-5120-L	64
R2M-2012-23-1012	62	<b>RM699BV-3011-85-1048</b>	88	RUC-2013-26-1012-KL	63	RUC-2052-26-5230	64
<b>R2M-2012-23-1024</b>	62	<b>RM699BV-3011-85-1060</b>	88	RUC-2013-26-1012-L	63	RUC-2052-26-5230-K	64
R2M-2012-23-1110	62	RM699BV-3211-85-1005	88	<b>RUC-2013-26-1024</b>	63	RUC-2052-26-5230-KL	64
<b>R2M-2012-23-5120</b>	62	RM699BV-3211-85-1012	88	RUC-2013-26-1024-K	63	RUC-2052-26-5230-L	64
R2M-2012-23-5230	62	RM699BV-3211-85-1024	88	<b>RUC-2013-26-1024-KL</b>	63	RUC-2053-26-1012	64
R2N-2012-23-1012-WT	54	RM699BV-3211-85-1048	88	RUC-2013-26-1024-L	63	RUC-2053-26-1012-K	64
<b>R2N-2012-23-1012-WTL</b>	54	RM699BV-3211-85-1060	88	RUC-2013-26-1110	63	RUC-2053-26-1012-KL	64
<b>R2N-2012-23-1024-WT</b>	54	<b>RM84-2012-35-1012</b>	80	RUC-2013-26-1110-K	63	RUC-2053-26-1012-L	64
<b>R2N-2012-23-1024-WTL</b>	54	<b>RM84-2012-35-1024</b>	80	RUC-2013-26-1110-KL	63	RUC-2053-26-1024	64
R2N-2012-23-1110-WT	54	RM84-2012-35-1110	80	RUC-2013-26-1110-L	63	RUC-2053-26-1024-K	64
R2N-2012-23-1110-WTL	54	<b>RM84-2012-35-5120</b>	80	<b>RUC-2013-26-5120</b>	63	RUC-2053-26-1024-KL	64
R2N-2012-23-5024-WT	54	<b>RM84-2012-35-5230</b>	80	RUC-2013-26-5120-K	63	RUC-2053-26-1024-L	64
<b>R2N-2012-23-5024-WTL</b>	54	<b>RM84-2022-35-1012</b>	80	<b>RUC-2013-26-5120-KL</b>	63	RUC-2053-26-1110	64
<b>R2N-2012-23-5120-WT</b>	54	<b>RM84-2022-35-1024</b>	80	RUC-2013-26-5120-L	63	RUC-2053-26-1110-K	64
<b>R2N-2012-23-5120-WTL</b>	54	RM84-2022-35-1110	80	<b>RUC-2013-26-5230</b>	63	RUC-2053-26-1110-KL	64
R2N-2012-23-5230-WT	54	<b>RM84-2022-35-5120</b>	80	RUC-2013-26-5230-K	63	RUC-2053-26-1110-L	64
<b>R2N-2012-23-5230-WTL</b>	54	<b>RM84-2022-35-5230</b>	80	RUC-2013-26-5230-KL	63	RUC-2053-26-5120	64
R3N-2013-23-1012-WT	54	<b>RM85-2011-35-1012</b>	80	RUC-2013-26-5230-L	63	RUC-2053-26-5120-K	64
<b>R3N-2013-23-1012-WTL</b>	54	<b>RM85-2011-35-1024</b>	80	RUC-2022-26-1012	63	RUC-2053-26-5120-KL	64
R3N-2013-23-1024-WT	54	RM85-2011-35-1110	80	RUC-2022-26-1012-K	63	RUC-2053-26-5120-L	64
<b>R3N-2013-23-1024-WTL</b>	54	<b>RM85-2011-35-5120</b>	80	RUC-2022-26-1012-KL	63	RUC-2053-26-5230	64
R3N-2013-23-1110-WT	54	<b>RM85-2011-35-5230</b>	80	RUC-2022-26-1012-L	63	RUC-2053-26-5230-K	64
R3N-2013-23-1110-WTL	54	<b>RM85-2021-35-1012</b>	80	RUC-2022-26-1024	63	RUC-2053-26-5230-KL	64
R3N-2013-23-5024-WT	54	<b>RM85-2021-35-1024</b>	80	RUC-2022-26-1024-K	63	RUC-2053-26-5230-L	64
<b>R3N-2013-23-5024-WTL</b>	54	RM85-2021-35-1110	80	RUC-2022-26-1024-KL	63	<b>RY2-2012-26-1012</b>	62
<b>R3N-2013-23-5120-WT</b>	54	<b>RM85-2021-35-5120</b>	80	RUC-2022-26-1110	63	RY2-2012-26-1012-D	62
<b>R3N-2013-23-5120-WTL</b>	54	<b>RM85-2021-35-5230</b>	80	RUC-2022-26-1110-K	63	RY2-2012-26-1012-L	62
R3N-2013-23-5230-WT	54	<b>RM87N-2011-35-1012</b>	80	RUC-2022-26-1110-KL	63	RY2-2012-26-1012-LD	62
<b>R3N-2013-23-5230-WTL</b>	54	<b>RM87N-2011-35-1024</b>	80	RUC-2022-26-1110-L	63	<b>RY2-2012-26-1024</b>	62
R4N-2014-23-1012-WT	54	RM87N-2011-35-1110	80	RUC-2022-26-5120	63	RY2-2012-26-1024-D	62
<b>R4N-2014-23-1012-WTL</b>	54	<b>RM87N-2011-35-5120</b>	80	RUC-2022-26-5120-K	63	<b>RY2-2012-26-1024-L</b>	62
<b>R4N-2014-23-1024-WT</b>	54	<b>RM87N-2011-35-5230</b>	80	RUC-2022-26-5120-KL	63	RY2-2012-26-1024-LD	62
<b>R4N-2014-23-1024-WTL</b>	54	<b>RM87N-2021-35-1012</b>	80	RUC-2022-26-5120-L	63	RY2-2012-26-1110	62
R4N-2014-23-1110-WT	54	<b>RM87N-2021-35-1024</b>	80	RUC-2022-26-5120-L	63	RY2-2012-26-1110-D	62
<b>R4N-2014-23-1110-WTL</b>	54	RM87N-2021-35-1110	80	RUC-2022-26-5230	63	RY2-2012-26-1110-L	62
R4N-2014-23-5024-WT	54	<b>RM87N-2021-35-5120</b>	80	RUC-2022-26-5230-K	63	RY2-2012-26-1110-LD	62
<b>R4N-2014-23-5024-WTL</b>	54	<b>RM87N-2021-35-5230</b>	80	RUC-2022-26-5230-KL	63	RY2-2012-26-5024	62
<b>R4N-2014-23-5120-WT</b>	54	<b>RSR30-D05-A1-24-020-1</b>	84	RUC-2022-26-5230-L	63	RY2-2012-26-5024-D	62
<b>R4N-2014-23-5120-WTL</b>	54	<b>RSR30-D05-D1-02-040-1</b>	86	RUC-2023-26-1012	63	<b>RY2-2012-26-5024-L</b>	62
R4N-2014-23-5230-WT	54	<b>RSR30-D05-D1-04-025-1</b>	85	RUC-2023-26-1012-K	63	RY2-2012-26-5024-LD	62
<b>R4N-2014-23-5230-WTL</b>	54	<b>RSR30-D05-D1-24-010-1</b>	87	RUC-2023-26-1012-KL	63	<b>RY2-2012-26-5120</b>	62
RM40-2011-85-1003	75	<b>RSR30-D12-A1-24-020-1</b>	84	RUC-2023-26-1012-L	63	RY2-2012-26-5120-D	62
RM40-2011-85-1005	75	<b>RSR30-D12-D1-02-040-1</b>	86	RUC-2023-26-1024	63	<b>RY2-2012-26-5120-L</b>	62
RM40-2011-85-1006	75	<b>RSR30-D12-D1-04-025-1</b>	85	RUC-2023-26-1024-K	63	RY2-2012-26-5120-LD	62
RM40-2011-85-1009	75	<b>RSR30-D12-D1-24-010-1</b>	87	RUC-2023-26-1024-KL	63	RY2-2012-26-5230	62
RM40-2011-85-1012	75	<b>RSR30-D24-A1-24-020-1</b>	84	RUC-2023-26-1024-L	63	RY2-2012-26-5230-D	62
RM40-2011-85-1024	75	<b>RSR30-D24-D1-02-040-1</b>	86	RUC-2023-26-1110	63	<b>RY2-2012-26-5230-L</b>	62
RM40-2011-85-1048	75	<b>RSR30-D24-D1-04-025-1</b>	85	RUC-2023-26-1110-K	63	RY2-2012-26-5230-LD	62
RM40-3021-85-1003	75	<b>RSR30-D24-D1-24-010-1</b>	87	RUC-2023-26-1110-KL	63		
RM40-3021-85-1005	75	<b>RSR30-D48-D1-02-040-1</b>	86	RUC-2023-26-1110-L	63		
RM40-3021-85-1006	75	<b>RSR30-D48-D1-04-025-1</b>	85	RUC-2023-26-5120	63		
RM40-3021-85-1009	75	<b>RSR30-D48-D1-24-010-1</b>	87	RUC-2023-26-5120-K	63		
RM40-3021-85-1012	75	<b>RUC-2012-26-1012</b>	62	RUC-2023-26-5120-KL	63		
RM40-3021-85-1024	75	RUC-2012-26-1012-K	62	RUC-2023-26-5120-L	63		
RM40-3021-85-1048	75	RUC-2012-26-1012-KL	62	RUC-2023-26-5230	63		
RM50-3011-85-1003	75	RUC-2012-26-1012-L	62	RUC-2023-26-5230-K	63		
RM50-3011-85-1005	75	<b>RUC-2012-26-1024</b>	62	RUC-2023-26-5230-KL	63		
RM50-3011-85-1006	75	RUC-2012-26-1024-K	62	RUC-2023-26-5230-L	63		
RM50-3011-85-1009	75	<b>RUC-2012-26-1024-KL</b>	62	RUC-2052-26-1012	64		
RM50-3011-85-1012	75	RUC-2012-26-1024-L	62	RUC-2052-26-1012-K	64		
RM50-3011-85-1018	75	RUC-2012-26-1110	62	RUC-2052-26-1012-KL	64		
RM50-3011-85-1024	75	RUC-2012-26-1110-K	62	RUC-2052-26-1012-L	64		
RM50-3011-85-1048	75	RUC-2012-26-1110-KL	62	RUC-2052-26-1024	64		
RM50-3021-85-1003	75	RUC-2012-26-1110-L	62	RUC-2052-26-1024-K	64		
RM50-3021-85-1005	75	<b>RUC-2012-26-5120</b>	62	RUC-2052-26-1024-KL	64		
RM50-3021-85-1006	75	RUC-2012-26-5120-K	62	RUC-2052-26-1024-L	64		
RM50-3021-85-1009	75	<b>RUC-2012-26-5120-KL</b>	62	RUC-2052-26-1110	64		
RM50-3021-85-1012	75	RUC-2012-26-5120-L	62	RUC-2052-26-1110-K	64		

**BOLD - Regular stocked items.**

# STANDARD TERMS AND CONDITIONS OF SALE

**TITLE** - Title to the products of ALTECH shall remain with ALTECH until payment is made in full by Customer. Such reservation of title is for the purpose of securing the purchase price and shall not relieve Customer of the duty to inspect the products upon receipt, to notify ALTECH of any deficiencies or defects, and to exercise due care in the use, installation, operation, and maintenance of the products when on the premise of the Customer or under the control of the Customer. Notwithstanding any reservation of title by ALTECH, risk of loss shall pass to customer at any time of shipment.

**SHIPMENT AND DELIVERY** - All orders for destination in the mainland United States (less Hawaii, Alaska and non-continental United States possessions) will be shipped F.O.B. Flemington, N.J. All destination, shipping and other charges shall be paid by the Customer in accordance with ALTECH's then current shipping and billing practices.

Delivery dates given in the acceptance of any order are approximate. ALTECH shall not be liable for delays in delivery or in performance due to causes beyond its reasonable control including acts of God, acts of Customer, acts of civil or military authority, fires, strikes or other labor disturbances, war, riot or delays in transportation. In the event of such delay, the date of delivery or performance shall be extended for a period equal to the time lost by reason of the delay.

**PRICE** - PRICES in any ALTECH publication are subject to change without prior notification. Catalog prices are based on prices published in the current price list. All written quotations are valid for thirty (30) days from the date of quotation. Customer shall pay all sales, use, excise or similar taxes whenever ALTECH must itself pay and/or collect such tax from Customer arising out of the sale.

**PAYMENT** - Customer agrees to make payment within thirty (30) days of date of the invoice from ALTECH. Customer agrees to pay a late payment charge of one and one-half percent (1.5% per month, or the maximum late payment charge permitted by applicable law, whichever is less, on any unpaid amount for each calendar month (or fraction thereof) that such payment is in default. Orders amounting to less than \$100.00 will be billed at \$100.00 plus freight. Full carton purchases are required. In the event of referral to an attorney for collection, reasonable attorney's fees for collection of the overdue amount shall be paid by Customer. In the event payment is not received within 30 days from the date of invoice, any discount shall be cancelled and the full list price will be due.

**LIMITED WARRANTY** - ALTECH warrants to Customer that the equipment purchases shall be free from defects in material and workmanship under normal use and service for a period of one year from shipment.

Written notice as an explanation of the circumstances of any claim that the equipment has proved defective in material or workmanship shall be given promptly by the Customer to ALTECH.

ALTECH will not be liable for any misuse, improper operations, improper installation, improper maintenance, alteration, modification, accident or unusual degradation of the equipment or parts due to an unsuitable installation environment.

No representation of other affirmation of facts, including but not limited to statements regarding capacity, suitability for use or performance of the equipment, shall be or be deemed to be a warranty or representation by ALTECH for any purpose, nor give rise to any liability or obligation of ALTECH whatsoever.

Customer's sole and exclusive remedy in the event of breach of warranty, as set forth herein, is expressly limited to (1) the correction of the defect by adjustment, repair, modification, or replacement, or (2) issuance of a credit or refund of the purchase price for the defective equipment at ALTECH's election and sole expense.

EXCEPT AS SPECIFICALLY PROVIDED IN THIS AGREEMENT, THERE ARE NO OTHER WARRANTIES EXPRESSED OR IMPLIED INCLUDING BUT NOT LIMITED TO ANY IMPLIED WARRANTIES OR MERCHANTABILITY OR FITNESS FOR A PARTICULAR PURPOSE.

THIS WARRANTY EXTENDS ONLY TO THE CUSTOMER FROM ALTECH OR ITS AUTHORIZED DISTRIBUTOR.

**LIMITATION OF LIABILITY** - IN NO EVENT, SHALL ALTECH BE LIABLE FOR LOSS OF PROFITS, INDIRECT, SPECIAL, CONSEQUENTIAL OR OTHER SIMILAR DAMAGES ARISING OUT OF ANY BREACH OF THIS AGREEMENT OR OBLIGATIONS UNDER THE AGREEMENT.

ALTECH SHALL NOT BE LIABLE FOR ANY DAMAGES CAUSED BY DELAY IN SHIPMENT, INSTALLATION OR FURNISHING OF EQUIPMENT OR SERVICES UNDER THIS AGREEMENT.

No action arising out of any claimed breach of this Agreement may be brought by either party more than two (2) years after the cause of action has accrued.

**PATENT INDEMNITY** - ALTECH shall defend or settle any suit or proceeding brought against Customer based on a claim that any equipment made to ALTECH design and furnished hereunder constitutes an infringement of any existing United States patent, provided (ALTECH) is notified promptly in writing and is given complete authorization and information required for the defense, and ALTECH shall pay all damages and costs awarded against Customer, but shall not be responsible for any costs, expense or compromise incurred or made by Customer without ALTECH's prior written consent. If any equipment is in ALTECH's opinion likely to or does become the subject of a claim for patent infringement, ALTECH may at its option and expense procure for Customer the right to continue using the device, modify it to become non-infringing, but in the event ALTECH is not reasonably able to modify, substitute, or otherwise procure for Customer the right to continue using it, ALTECH will remove such equipment and refund to Customer the amount paid in excess of a reasonable rental for past use.

ALTECH shall not be liable for any infringement or claim based upon use of the equipment in combination with other equipment not supplied by ALTECH or with modifications made by Customer.

The foregoing states the entire liability of ALTECH to Customer arising from patent infringement.

**SELLER'S REMEDIES** - Should Customer fail to make any payment within ten (10) days of its due date, or fail to perform any other of the Customer's obligation hereunder upon thirty (30) days written notice, or should Customer be or become insolvent or be a party to any bankruptcy receivership proceeding prior to full payment of all amounts payable hereunder, ALTECH may: (a) with or without demand or notice to customer declare the entire amount unpaid immediately due and payable; (b) enter upon the premises where the equipment may be found and remove it (Customer shall assemble the equipment and make it available to ALTECH at a place reasonably convenient to both parties and shall permit and assist ALTECH in effecting the retaking and removal of the equipment); and (c) sell any or all the equipment as permitted under applicable law, applying the proceeds of the sale to payment of the expenses of retaking, repairing and selling the equipment, reasonable attorney fees and to the satisfaction of all indebtedness then due and unpaid under this Agreement. Any surplus shall be paid to Customer and any deficiency shall be paid to ALTECH by Customer.

The remedies provided herein shall be cumulative and in addition to all other remedies provided by law or equity or under the Uniform Commercial Code.

**GOVERNING LAW** - This agreement will be governed by the Laws of the State of New Jersey.

**GENERAL** - This Agreement shall only become effective and binding when either (a) it has been accepted and executed by an authorized representative of ALTECH, or (b) the equipment has been shipped to Customer, with or without acceptance in writing hereon. Notice of acceptance is hereby waived by Customer. Customer hereby acknowledges receipt of a true and complete copy hereof.

No addition to or modification of any of the Terms and Conditions of Sale as they appear herein shall be binding upon ALTECH unless signed in writing by duly authorized representative of ALTECH in Flemington, N.J.

Typographical and clerical errors in quotations, orders and acknowledgments are subject to correction.

This Agreement is not assignable without the prior written consent of ALTECH. Any attempt to assign any of the rights, duties or obligations of this Agreement without such consent is void.

If any provision or provisions of this Agreement shall be held to be invalid, illegal or unenforceable, the validity, legality and enforceability, of the remaining provisions shall not in any way be affected or impaired thereby.

ALTECH is not responsible for failure to fulfill its obligation under this Agreement due to causes beyond its control, or except as agreed herein.

THE CUSTOMER ACKNOWLEDGES THAT HE HAS READ THE AGREEMENT, UNDERSTANDS IT, AND AGREES TO BE BOUND BY ITS TERMS AND CONDITIONS. FURTHERMORE, THE CUSTOMER AGREES THAT IT IS THE COMPLETE AND EXCLUSIVE STATEMENT OF THE AGREEMENT BETWEEN THE PARTIES, WHICH SUPERSEDES ALL PROPOSALS OR PRIOR AGREEMENTS, ORAL OR WRITTEN, EXPRESSED OR IMPLIED, AND ALL OTHER COMMUNICATIONS BETWEEN THE PARTIES RELATING TO THE SUBJECT MATTER OF THIS AGREEMENT.

## Circuit Protection Devices



Altech the market leader in UL508 Manual Motor Controllers/ Miniature Circuit Breakers now introduces UL489 Miniature Circuit Breakers and UL1077 Supplementary Protectors. The UL489 versions are DIN rail mounted, 17.5mm wide, thermal magnetic, 240V, 480Y/277V AC, 50/60Hz, 125 and 250 VDC models, with short circuit interrupt capacity of 10kA, a positive trip indicator, and are line/load reversible. The UL1077 versions are DIN rail mounted, 17.5mm wide, thermal magnetic, 480Y/277V AC, 50/60Hz, a short circuit withstand capacity 10kA, have a positive trip indicator.

**Altech Corp.®**  
35 Royal Rd., Flemington, NJ 08822  
908-806-9400  
FAX 908-806-9490  
[www.altechcorp.com](http://www.altechcorp.com)

## Metallic Push Buttons and Selector Switches

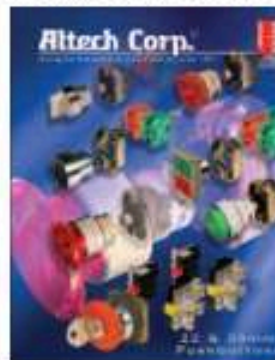

Altech 22 and 30 mm Push Buttons offer ideal cost-effective solutions for control circuits utilizing both direct and remote management applications. Ease of assembly has been engineered into the design; the only tool necessary for installation is a screwdriver.

- LED Indicating Devices
- Pilot Lights
- Push Button Stations
- Push Button Enclosures
- UL Recognized
- Custom Push Button Assemblies
- All Very Competitively Priced

**Altech Corp.®**  
35 Royal Rd., Flemington, NJ 08822  
908-806-9400  
FAX 908-806-9490  
[www.altechcorp.com](http://www.altechcorp.com)

## Contactors and More!

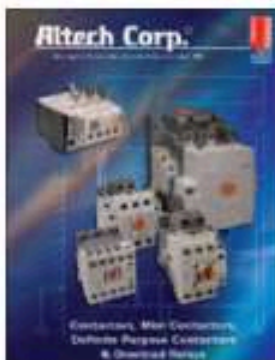

Altech's now carries contactors, mini contactors, definite purpose contactors & overload relays. The contactors come in 3 and 4 pole configurations at 9A to 800A. Available in Single Phase (115 - 230V) and Three Phase (200 - 575V) AC and DC models. A large variety of coil voltages are supported and the accessories are auxiliary contacts and overload relays. The mini contactors come in screw clamp, fast-on, cage clamp and solder pin types.

**Altech Corp.®**  
35 Royal Rd., Flemington, NJ 08822  
908-806-9400  
[www.altechcorp.com](http://www.altechcorp.com)

## Terminal Blocks



Altech offers a NEW Terminal Block catalog with the most competitively priced blocks in the industry. We feature screw and spring clamp models for DIN rail and panel mount applications. This advanced line of wire termination products will increase your design options and help to get the job done more efficiently. Our line of blocks include feed-through (single, double or triple level), distribution, ground, fuse, disconnect, thermocouple, surge suppressor and indicator. A wide variety of accessories, tools and ferrules are available.

**Altech Corp.®**  
35 Royal Rd., Flemington, NJ 08822  
908-806-9400  
FAX 908-806-9490  
[www.altechcorp.com](http://www.altechcorp.com)

## Industrial Enclosures



Altech's expanded line of TK Industrial Enclosures, with metric knockouts, is here. Now our entire line of industrial enclosures is in metric. Metric knockouts align with international standards making selection easier and more universal. Plus the PG standard is still available. All of Altech's enclosures are internationally accepted and stand up to the harshest environments. They protect against dust, water and corrosion while enhancing the value of your product. Rated up to IP66 (NEMA type 4x), Altech enclosures are available in a wide range of sizes.

**Altech Corp.®**  
35 Royal Rd., Flemington, NJ 08822  
908-806-9400  
[www.altechcorp.com](http://www.altechcorp.com)

## DIN Rail Power Supplies



Altech DIN RAIL mountable power supplies have Universal AC input. They are suitable for industrial and automation applications.

- UL508 Listed
- Installed on DIN rail TS35/ 7.5 or 15
- Available from 20-960W
- Protection: Short circuit / Overload / Over-voltage / Over temperature
- Cooling by free air convection
- Worldwide approvals
- 3 year warranty

**Altech Corp.®**  
35 Royal Rd., Flemington, NJ 08822  
908-806-9400  
FAX 908-806-9490  
[www.altechcorp.com](http://www.altechcorp.com)

## Altech Corp.®

Quality  
Endorsed  
Company



ISO 9001  
CERTIFICATE

Altech Search



Home

Back Order

Directories

Information

News

Contact

Buy Direct Login

Altech Alerts



### WEB TOOLS

- Product Catalogs
- Request for Quote
- Sample Request
- Catalog Request

### PRODUCT MENU

- Circuit Protection / Control >
- Connectors >
- Enclosures >
- European Spare Parts >
- Foot Switches
- Sensor Modules >
- Power Supplies
- Push Buttons & Pilot Lights >
- Relays >
- Terminal Blocks >
- Wire & Cable Management >
- Home

### New Products and Promotions

## Serving the Automation & Control Industry Since 1984

### Circuit Protection



Circuit Protection Devices



Rubber and Power Distribution



Connectors, Overload Relays, Manual Motor Starters



Motor Disconnect Switches



European Fuses

### Connectors



Industrial Rectangular Connectors



Pin & Sleeve Drivers



Receptacles



Foot Switches



Inductive Proximity Sensors

### Enclosures



Industrial Enclosures



DIN Enclosures

### Modules & Relays



Interface Modules



Safety Relays



Signal Relays

### Power Supplies



Power Supplies

### Push Buttons



22 & 30 mm Push Buttons

### DIN Rail



DIN Rail

### Wire & Cable Management



Liquid Tight Strain Relief/Clamp-on Tubes



Wire Duct

### Terminal Blocks



DIN Rail Terminal Blocks



Panel Mount Terminal Blocks



Printed Circuit Board Terminal Blocks



Earrings



Distribution Blocks

### Miscellaneous



Terminals



Custom Assembly



Marking & Engraving Systems



Power Terminals/Conductors



European Spare Parts

Altech Corporation  
35 Royal Road  
Flemington, NJ 08822-6000  
P 908.806.9400 • F 908.806.9490  
www.altechcorp.com



Altech Corp.® 410-112013-5M  
Printed November 2013