

OVERVIEW

SCREW TERMINAL BLOCKS

INTRODUCTION

SCREW CLAMP CONNECTION TECHNOLOGY



- Maximum wiring efficiency and reliability
- Supplied with open clamps ready to accept wires
- No wire preparation necessary (with/ without ferrule)
- Vibration resistant/ Gas-tight connection
- For very larger wire sizes (up to 250 kcmil)
- Designed for most stringent requirements
- Simple connection with standard flat head screwdriver



60947-7-1

MATERIAL SPECIFICATIONS

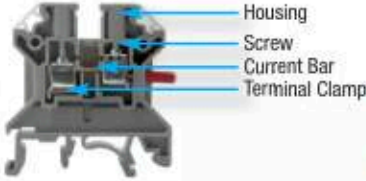

Current Carrying Metal *Corrosion free material*

- Clamp: zinc chromate passivated steel
- Screw: zinc chromate passivated steel
- Current Bar: nickel plated copper alloy / tin plated copper

Terminal Block Housing

- Polyamide PA66 Housing
- Self-extinguishing
- High mechanical strength

Polyamide 66 Specifications

- Upper Temperature Limit: 105°C
- Lower Temperature Limit: -50°C
- Flammability UL94: V2/ V0
- Volume Resistivity: $10^{12} \Omega \text{ cm}$
- Surface Resistivity: $10^{10} \Omega$

INSTALLATION GUIDELINES

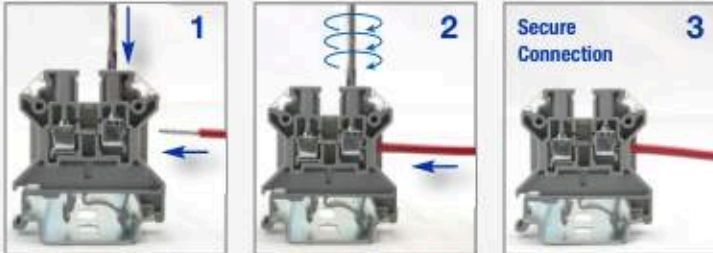

- 1 Insert Wire into open clamp
- 2 Tighten screw to specified torque
- 3 Remove Screwdriver, screw terminal is closed with locking feature for a reliable/ safe connection

SCREW CLAMP ACCESSORIES AND FEATURES

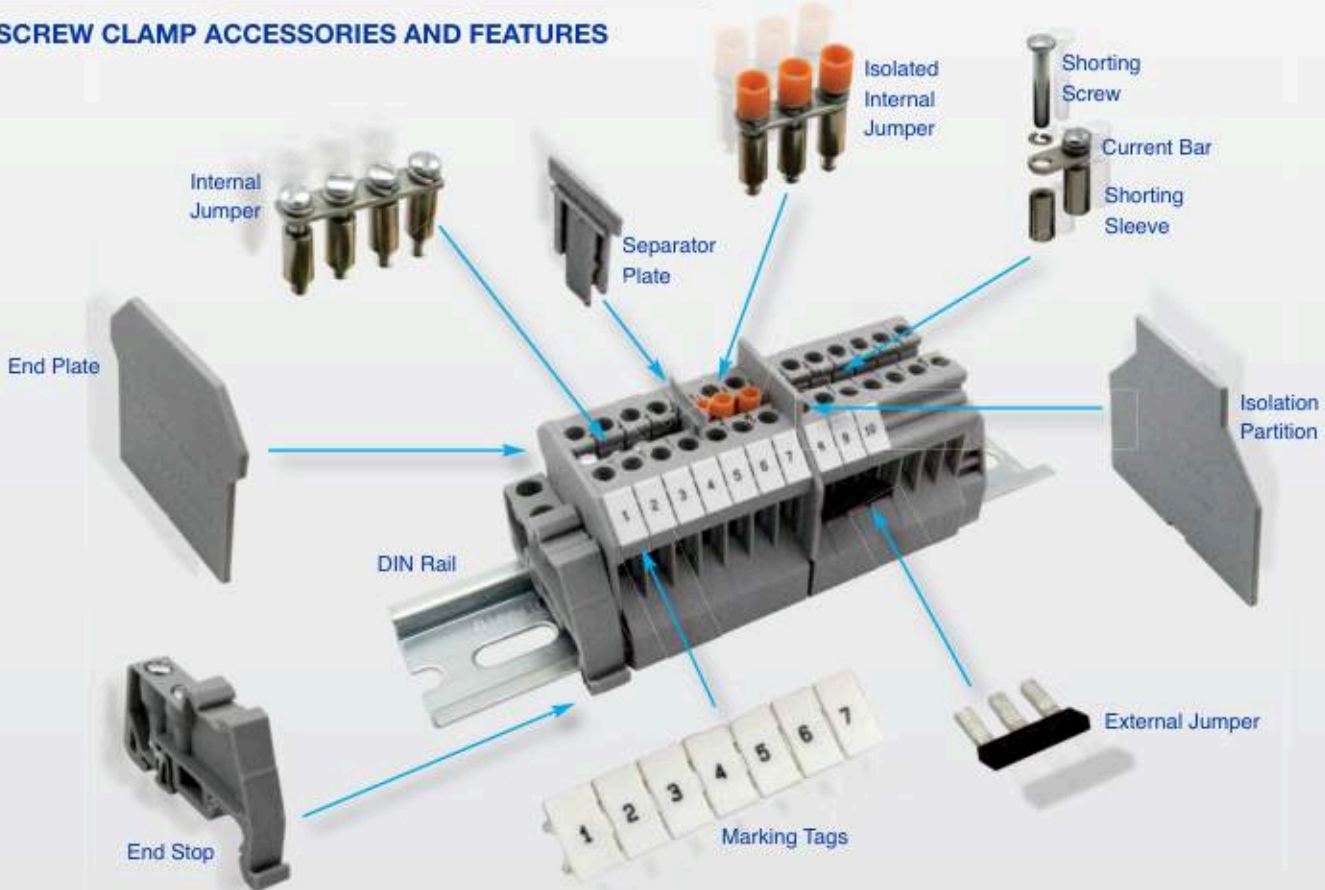

Feed Through Terminal Blocks

- Up to 240A
- Multi-Connection Terminals
- Double Level Terminal
- Triple Level Terminals
- Ground Blocks
- Wide range of accessories
- All standard colors



Feed Through
page 6-8



Multi-Connection
page 9



Double Level
page 10-12



Triple Level
page 14-15



Ground / Earth
page 16-17

Fuse Terminal Blocks

- 1/4" x 1" Fuse Terminal Blocks
- 5x20mm/ 5x25mm Fuse Terminal Blocks
- Double level versions
- Component Carrier for flexible requirements
- 10x38, CC, J-Type Fuse Holder



5x20mm / 5x25mm
CF4U / CF4SP
page 18-19



Double Lever
DDFL4U
page 20-21



1/4"x1"
CAFL4U
page 22



Component Carrier
CCC4U
page 23



Fuse Holder
page 24-25

Disconnect & Test Terminal Blocks

- Slider Style
- Blade/ Knife Style
- Lever Style
- Accessories and matching Feed Through terminals



Slider Style
CDS6U
page 26-27



Blade Style
CKT4U
page 28



Blade Style
CKT4SP
page 29



Slider Style
CDDTU
page 30



Lever Style
CSDL4U
page 31

Power Distribution Terminal Blocks

- Various I/O configurations
- Up to 150A
- Compact Hybrid Distribution Block



CDB Series
page 32-33



CMD8 Series
page 34



Hybrid CXDB Series
page 35



Distribution/Grounding
page 36

Special Application Terminal Blocks

- Spring Loaded Terminals for high vibration applications
- 1000V High Voltage Terminals
- Thermocouple Terminals
- Tab Connection Terminals
- Electronic Components Terminals



1000V High Voltage
CHV Series
page 37



Thermocouple
CTT2.5U Series
page 38



Tab Connection
CTC Series
page 39



Spring Loaded
USC Series
page 36-37



Electronic
Components
page 42-47

Accessories

- Internal Jumpers (Uninsulated, Insulated)
- Endplates
- Partition/ Separator Plates
- Protective Covers
- End Stops



Jumpers
page 48



Endplates, Separators, End Stops, Covers, etc.
page 49

HIGHLIGHTS

FEATURES

- Aitech CTS Series of Universal Screw Terminal Blocks featuring global standards
- Universal mounting foot for easy snap onto common DIN rail profiles
- Screw-type jumper system
- Current Ratings up to 240A

APPLICATIONS

- Ex & IECEx approvals for use in potentially explosive areas
- Control, Automation applications
- Power Distribution

CTS2.5U-N



CTS4U-N



CTS6U



Dimensions & Weight

	CTS2.5U-N	CTS4U-N	CTS6U
Width	5 mm	6 mm	8 mm
Length	43 mm	43 mm	43 mm
Height w/ DIN Rail	35 x 7.5 mm 35 x 15 mm	46.2 mm 53.7 mm	47.8 mm 55.5 mm
Weight per piece	6.2 g	7.6 g	13.5 g

Technical Data/Ratings

Approvals	CTS2.5U-N		CTS4U-N		CTS6U	
	UL US E220514	SP US 60947-7-1	UL US E220514	SP US 60947-7-1	UL US E220514	SP US 60947-7-1
Wire Size (solid / stranded)	22-12 AWG	0.2-2.5 mm ²	22-10 AWG	0.2-4 mm ²	22-8 AWG	0.5-6 mm ²
Voltage Rating	600 V	1000V AC/DC	600 V	1000V AC/DC	600 V	1000V AC/DC
Current Rating	25 A	24 A	35 A	32 A	50 A	41 A
Torque	7 lb-in	0.4 Nm	7 lb-in	0.5 Nm	14 lb-in	0.8 Nm
Insulation Material	Polyamide 66		Polyamide 66		Polyamide 66	

Installation Instructions

	CTS2.5U-N	CTS4U-N	CTS6U
Wire Stripping Length	8 mm	8 mm	9 mm
Screwdriver	Flat Head 0.5 x 3.0 mm	Flat Head 0.6 x 3.5 mm	Flat Head 0.8 x 4.0 mm

Terminal Blocks

	Cat. No.	Std. Pk.	Cat. No.	Std. Pk.	Cat. No.	Std. Pk.
Grey (standard)	CTS2.5U-N	100	CTS4U-N	100	CTS6U	100
Red R	CTS2.5U-N/R	100	CTS4U-N/R	100	CTS6U/R	100
Blue BU	CTS2.5U-N/BU	100	CTS4U-N/BU	100	CTS6U/BU	100
Black BL	CTS2.5U-N/BL	100	CTS4U-N/BL	100	CTS6U/BL	100
Orange O	CTS2.5U-N/O	100	CTS4U-N/O	100	CTS6U/O	100
Green G	CTS2.5U-N/G	100	CTS4U-N/G	100	CTS6U/G	100
Yellow Y	CTS2.5U-N/Y	100	CTS4U-N/Y	100	CTS6U/Y	100
White W	CTS2.5U-N/W	100	CTS4U-N/W	100	CTS6U/W	100

Accessories

	Cat. No.	Std. Pk.	Cat. No.	Std. Pk.	Cat. No.	Std. Pk.	
End Plate	EP2.5/4UN	50	EP2.5/4UN	50	EP6/10U	50	
Partition Plate	PP2.5/4UN	50	PP2.5/4UN	50	PP6/10U	50	
Separator Plate	SP2.5/4UN	100	SP2.5/4UN	100	SP6/10U	100	
DIN Rail	2511120 CA701-15/S 2511160	20 20 10	2511120 CA701-15/S 2511160	20 20 10	2511120 CA701-15/S 2511160	20 20 10	
End Stop	CA702 CA802 CA202	50 50 25	CA702 CA802 CA202	50 50 25	CA702 CA802 CA202	50 50 25	
Internal Jumper	2 pole 3 pole 4 pole 10 pole 100 pole	CA721/2 CA721/3 CA721/4 CA721/10 CA721/100	100 100 100 10 10	CA722/2 CA722/3 CA722/4 CA722/10 CA722/100	100 100 50 10 10	CA723/2 CA723/3 CA723/4 CA723/10 -	100 50 50 10 -
Insulated Internal Jumper	2 pole 3 pole 4 pole 10 pole 100 pole	CA741/2 CA741/3 CA741/4 CA741/10 CA741/100	100 100 100 10 10	CA742/2 CA742/3 CA742/4 CA742/10 CA742/100	100 100 100 10 10	CA743/2 CA743/3 CA743/4 CA743/10 -	100 50 50 10 -
External Jumper	2 pole 3 pole 4 pole 10 pole	CA717/2 CA717/3 CA717/4 CA717/10	100 100 100 20	CA714/2 CA714/3 CA714/4 CA714/10	100 100 100 20	CA710/2 CA710/3 CA710/4 CA710/10	100 50 50 20
Test Socket	CA707/TS/01	100	CA707/TS/01	100	CA707/TS/05	100	
Marking Tag	MT5	1 Pk. (100 tags)	MT6	1 Pk. (100 tags)	MT8	1 Pk. (100 tags)	



Mounting Handle

Mounting handle is used for mounting 10 terminal blocks on a DIN rail, thus saving considerable time. Specially designed pins in the mounting handle grip the terminal blocks when pressed against entry.

Cat. No. Terminal Block Std. Pk.

MH2.5	CTS2.5U-N	1
MH4	CTS4U-N	1



CTS10U



CTS16U



CTS25UN



CTS35UN



Dimensions & Weight

Width	10 mm	12 mm	12 mm	16 mm
Length	43 mm	43 mm	49 mm	50.5 mm
Height w/ DIN Rail	35 x 7.5 mm 35 x 15 mm	47.8 mm 55.5 mm	47.8 mm 55.5 mm	57.2 mm 64.7 mm
Weight per piece	16.5 g	25.5 g	35.5 g	50.5 g

Technical Data/Ratings

Approvals										
Wire Size (solid / stranded)	16-6 AWG	22-6 AWG	0.5-10 mm ²	20-4 AWG	22-6 AWG	0.2-16 mm ²	14-2 AWG	4-25 mm ²	12-1/0 AWG	4-35 mm ²
Voltage Rating	600 V	600 V	1000V AC/DC	600 V	600 V	1000V AC/DC	600 V	1000V AC/DC	600 V	1000V AC/DC
Current Rating	65 A	65 A	57 A	85 A	70 A	76 A	105 A	101 A	150 A	125 A
Torque	14 lb-in	14 lb-in	1.2 Nm	14 lb-in	14 lb-in	1.2 Nm	30 lb-in	2.0 Nm	50 lb-in	2.5 Nm
Insulation Material	Polyamide 66			Polyamide 66			Polyamide 66		Polyamide 66	

Installation Instructions

Wire Stripping Length	11 mm	12 mm	14 mm	15 mm
Screwdriver	Flat Head 0.8 x 4.0 mm	Flat Head 1.0 x 5.5 mm	Flat Head 1.0 x 5.5 mm	Flat Head 1.0 x 5.5 mm

Terminal Blocks

Grey (standard) Red R Blue BU Black BL Orange O Green G Yellow Y White W	Cat. No.	Std. Pk.	Cat. No.	Std. Pk.	Cat. No.	Std. Pk.	Cat. No.	Std. Pk.
	CTS10U	100	CTS16U	50	CTS25UN	50	CTS35UN	50
	CTS10U/R	100	CTS16U/R	50	CTS25UN/R	50	CTS35UN/R	50
	CTS10U/BU	100	CTS16U/BU	50	CTS25UN/BU	50	CTS35UN/BU	50
	CTS10U/BL	100	CTS16U/BL	50	CTS25UN/BL	50	CTS35UN/BL	50
	CTS10U/O	100	CTS16U/O	50	CTS25UN/O	50	CTS35UN/O	50
	CTS10U/G	100	CTS16U/G	50	CTS25UN/G	50	CTS35UN/G	50
CTS10U/Y	100	CTS16U/Y	50	CTS25UN/Y	50	CTS35UN/Y	50	
CTS10U/W	100	CTS16U/W	50	CTS25UN/W	50	CTS35UN/W	50	

Accessories

End Plate		Cat. No.	Std. Pk.	Cat. No.	Std. Pk.	Cat. No.	Std. Pk.	Cat. No.	Std. Pk.
Partition Plate		EP6/10U	50	-	-	-	-	PP25UN	50
Separator Plate		PP6/10U	50	-	-	PP25UN	50	PP35UN	50
DIN Rail		SP6/10U	100	SP6/10U	100	-	-	-	-
End Stop		2511120	20	2511120	20	2511120	20	2511120	20
Internal Jumper	2 pole	CA701-15/S	20	CA701-15/S	20	CA701-15/S	20	CA701-15/S	20
	3 pole	2511160	10	2511160	10	2511160	10	2511160	10
	4 pole	CA724/2	100	CA751/2	50	CA725/2	50	CA771/2	50
	10 pole	CA724/3	50	CA751/3	50	CA725/3	20	CA771/3	20
	100 pole	CA724/4	50	CA751/4	50	CA725/4	20	CA771/4	20
Insulated Internal Jumper	10 pole	CA724/10	10	CA751/10	10	CA725/10	10	CA771/10	10
	100 pole	-	-	CA751/100	10	CA725/100	10	-	-
	2 pole	CA744/2	100	CA761/2	100	CA745/2	50	CA781/2	50
	3 pole	CA744/3	50	CA761/3	50	CA745/3	20	CA781/3	20
	4 pole	CA744/4	50	CA761/4	50	CA745/4	20	CA781/4	20
External Jumper	10 pole	CA744/10	10	CA761/10	10	CA745/10	10	CA781/10	10
	100 pole	-	-	CA761/100	10	CA745/100	10	-	-
	2 pole	CA718/2	100	-	-	-	-	-	-
	3 pole	CA718/3	50	-	-	-	-	-	-
Test Socket	4 pole	CA718/4	50	-	-	-	-	-	-
	10 pole	CA718/10	20	-	-	-	-	-	-
	2 pole	CA707/TS/05	100	CA707/TS/05	100	CA707/TS/06	100	CA707/TS/06	100
	4 pole	-	-	-	-	-	-	-	-
Marking Tag	10 pole	MT10	1 Pk. (100 tags)	MT12	1 Pk. (100 tags)	MT12	1 Pk. (100 tags)	MT16	1 Pk. (100 tags)

HIGHLIGHTS

FEATURES

- DIN Rail and Panel mountable
- Voltage Rating 1000V
- Current Rating up to 240A
- Hex Screw version for easier tightening (NA)
- Auxiliary block for easy plug in

APPLICATIONS

- Power Distribution
- Solar Applications
- **AUX6** auxiliary for indicator light or contactor

CTS50/70N



CTS50/70NA



CTS95/120N



Dimensions & Weight

	CTS50/70N	CTS50/70NA	CTS95/120N
Width	20.5 mm	20.5 mm	27.0 mm
Length	77.3 mm	77.3 mm	84.5 mm
Height w/ DIN Rail	35 x 7.5 mm 35 x 15 mm	71.1 mm 78.1 mm	83.0 mm 90.5 mm
Weight per piece	93.8 g	95.0 g	177.2 g

Technical Data/Ratings

Approvals	CE	UL	UL	UL	UL	UL	UL
Wire Size (solid / stranded)	8-2/0 AWG	10-70 mm ²	8-2/0 AWG	10-70 mm ²	2-250 KCMIL	25-120 mm ²	
Voltage Rating	1000 V	1000 V AC/DC	1000 V	1000 V AC/DC	1000 V	1000 V AC/DC	
Current Rating	175 A	192 A	175 A	192 A	240 A	269 A	
Torque	38 lb-in	3.0 Nm	38 lb-in	3.0 Nm	90 lb-in	6.0 Nm	
Insulation Material	Polyamide 66		Polyamide 66		Polyamide 66		

Installation Instructions

Wire Stripping Length	22 mm	22 mm	24 mm
Screwdriver	Flat Head 1.0x7.5 mm	Allen Wrench 5 mm	Allen Wrench 6 mm

Terminal Blocks

	Cat. No.	Std. Pk.	Cat. No.	Std. Pk.	Cat. No.	Std. Pk.
Grey (standard)	CTS50/70N	20	CTS50/70NA	20	CTS95/120N	10
Red R	CTS50/70N/R	20	CTS50/70NA/R	20	CTS95/120N/R	10
Blue BU	CTS50/70N/BU	20	CTS50/70NA/BU	20	CTS95/120N/BU	10
Black BL	CTS50/70N/BL	20	CTS50/70NA/BL	20	CTS95/120N/BL	10
Orange O	CTS50/70N/O	20	CTS50/70NA/O	20	CTS95/120N/O	10
Green G	CTS50/70N/G	20	CTS50/70NA/G	20	CTS95/120N/G	10
Yellow Y	CTS50/70N/Y	20	CTS50/70NA/Y	20	CTS95/120N/Y	10
White W	CTS50/70N/W	20	CTS50/70NA/W	20	CTS95/120N/W	10

Accessories

	Cat. No.	Std. Pk.	Cat. No.	Std. Pk.	Cat. No.	Std. Pk.
DIN Rail	2511120	20	2511120	20	2511120	20
	CA701-15/S	20	CA701-15/S	20	CA701-15/S	20
	2511160	10	2511160	10	2511160	10
End Stop	CA702	50	CA702	50	CA702	50
	CA802	50	CA802	50	CA802	50
	CA202	25	CA202	25	CA202	25
Shorting Link System	CA628/2	10	CA628/2	10	CA629/2	10
	CA628/3	10	CA628/3	10	CA629/3	10
Marking Tag	MT16	1 Pk. (100 tags)	MT16	1 Pk. (100 tags)	MT16	1 Pk. (100 tags)

Cat. No AUX6

Auxiliary Terminal Block

Used for:
CTS50/70N
CTS50/70NA
CTS95/120N

In certain power circuits, there is a need to take an extra connection for an Auxiliary circuit like an indicating light or contactor. The AUX6 terminal easily plugs into the terminal and provides this extra connection point.



Ratings

IEC60947-7-1
Voltage/Current: 1000 V / 41 A
Torque: 0.8 Nm

IEC 60079-7
Voltage/Current: 630 V / 36 A
Torque: 0.8 Nm

UL-1059
Voltage/Current: 600 V / 50 A
Torque: 14 lb-in

CSA22.2-158
Voltage/Current: 600 V / 50 A
Torque: 14 lb-in

Wire Range: 22-8 AWG
Width x Length x Height: 8 x 53.6 x 29.4 mm
Std. Pk.: 10
Marking Tag: MT8

CMC1-2



CMC2-2

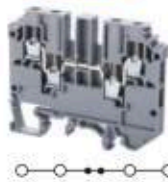

CMCG4

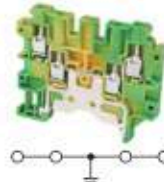

Dimensions & Weight

	6 mm	6 mm	6 mm
Width			
Length	46.5 mm	65.0 mm	65.0 mm
Height w DIN Rail	35 x 7.5 mm 35 x 15 mm	49.5 mm 56.5 mm	53.7 mm 60.9 mm
Weight per piece	11.0 g	16.0 g	21.6 g

Technical Data/Ratings

Approvals						
Wire Size (solid / stranded)	22-10 AWG	0.2-4 mm ²	22-10 AWG	0.2-4 mm ²	24-10 AWG	0.2-4 mm ²
Voltage Rating	600 V	630 V AC/DC	600 V	630 V AC/DC	600 V	1000 V AC/DC
Current Rating	35 A	32 A	35 A	32 A	-	-
Torque	7 lb-in	0.5 Nm	7 lb-in	0.5 Nm	4.5 lb-in	0.5 Nm
Insulation Material	Polyamide 66		Polyamide 66		Polyamide 66	

Installation Instructions

Wire Stripping Length	9 mm	9 mm	9 mm
Screwdriver	Flat Head 0.6 x 3.5 mm	Flat Head 0.6 x 3.5 mm	Flat Head 0.6 x 3.5 mm

Terminal Blocks

	Cat. No.	Std. Pk.	Cat. No.	Std. Pk.	Cat. No.	Std. Pk.
Grey (standard)	CMC1-2	100	CMC2-2	50	CMCG4	50
Red R	CMC1-2/R	100	CMC2-2/R	50	Yellow/Green	
Blue BU	CMC1-2/BU	100	CMC2-2/BU	50		
Black BL	CMC1-2/BL	100	CMC2-2/BL	50		
Orange O	CMC1-2/O	100	CMC2-2/O	50		
Green G	CMC1-2/G	100	CMC2-2/G	50		
Yellow Y	CMC1-2/Y	100	CMC2-2/Y	50		
White W	CMC1-2/W	100	CMC2-2/W	50		

Accessories

	Cat. No.	Std. Pk.	Cat. No.	Std. Pk.	Cat. No.	Std. Pk.
End Plate	EPCMC1-2	50	EPCMC2-2	50	EPCMC2-2	50
DIN Rail	2511120	20	2511120	20	2511120	20
	CA701-15/S	20	CA701-15/S	20	CA701-15/S	20
	2511160	10	2511160	10	2511160	10
End Stop	CA702	50	CA702	50	CA702	50
	CA802	50	CA802	50	CA802	50
	CA202	25	CA202	25	CA202	25
Internal Jumper	2 pole CA722/2	100	2 pole CA722/2	100	-	-
	3 pole CA722/3	100	3 pole CA722/3	100	-	-
	4 pole CA722/4	50	4 pole CA722/4	50	-	-
	10 pole CA722/10	10	10 pole CA722/10	10	-	-
	100 pole CA722/100	10	100 pole CA722/100	10	-	-
Insulated Internal Jumper	2 pole CA742/2	100	2 pole CA742/2	100	-	-
	3 pole CA742/3	100	3 pole CA742/3	100	-	-
	4 pole CA742/4	100	4 pole CA742/4	100	-	-
	10 pole CA742/10	10	10 pole CA742/10	10	-	-
	100 pole CA742/100	10	100 pole CA742/100	10	-	-
External Jumper	2 pole CA713/2	100	2 pole CA713/2	100	-	-
	3 pole CA713/3	100	3 pole CA713/3	100	-	-
	4 pole CA713/4	100	4 pole CA713/4	100	-	-
	10 pole CA713/10	20	10 pole CA713/10	20	-	-
Test Socket	CA707/TS/01		CA707/TS/01		-	-
Marking Tag	MT6	1 Pk. (100 tags)	MT6	1 Pk. (100 tags)	MT6	1 Pk. (100 tags)

HIGHLIGHTS

FEATURES

- 3 to 4 connections
- Up to 2 connection points on each side
- 2 jumper channels on **CMC2-2** for individual potential distribution
- **CMCG4** same profile as regular feed-through version

APPLICATIONS

- Connecting different type of wires with different wire sizes into a single terminal block
- Simple distribution applications

HIGHLIGHTS

FEATURES

- Accommodates larger **MT6** marking tags on both levels
- Independent and internally shorted version
- **CDL4UN** offers jumper channel on both levels
- Same profile Ground versions
- Grounding Level on **CDLG4** is identified by green/yellow imprint

APPLICATIONS

- High density writing applications

CDL4UN

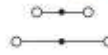

CDL4UN(I.S)

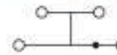

Dimensions & Weight

	CDL4UN	CDL4UN(I.S)
Width	6 mm	6 mm
Length	57.0 mm	57.0 mm
Height w DIN Rail	35 x 7.5 mm 35 x 15 mm	35 x 7.5 mm 35 x 15 mm
Weight per piece	13.8 g	15.6 g

Technical Data/Ratings

Approvals	CDL4UN		CDL4UN(I.S)	
	UL US E220514	CS 60947-7-1	UL US E220514	CS 60947-7-1
Wire Size (solid / stranded)	22-10 AWG	0.2-4 mm ²	22-10 AWG	0.2-4 mm ²
Voltage Rating	600 V	800 V AC/DC	600 V	800 V AC/DC
Current Rating	35 A	32 A	35 A	32 A
Torque	7 lb-in	0.5Nm	7 lb-in	0.5Nm
Insulation Material	Polyamide 66		Polyamide 66	

Installation Instructions

Wire Stripping Length	9 mm	9 mm
Screwdriver	Flat Head 0.6 x 3.5 mm	Flat Head 0.6 x 3.5 mm

Terminal Blocks

	Cat. No.	Std. Pk.	Cat. No.	Std. Pk.
Grey (standard)	CDL4UN	100	CDL4UN(I.S)	100
Red R	CDL4UN/R	100	CDL4UN(I.S)/R	100
Blue BU	CDL4UN/BU	100	CDL4UN(I.S)/BU	100
Black BL	CDL4UN/BL	100	CDL4UN(I.S)/BL	100
Orange O	CDL4UN/O	100	CDL4UN(I.S)/O	100
Green G	CDL4UN/G	100	CDL4UN(I.S)/G	100
Yellow Y	CDL4UN/Y	100	CDL4UN(I.S)/Y	100
White W	CDL4UN/W	100	CDL4UN(I.S)/W	100

Accessories

	Cat. No.	Std. Pk.	Cat. No.	Std. Pk.
End Plate	EPCDL4UN	50	EPCDL4UN	50
Separator Plate	SPCDL4U	100	SPCDL4U	100
DIN Rail	2511120 CA701-15/S 2511160	20 20 10	2511120 CA701-15/S 2511160	20 20 10
End Stop	CA702 CA802 CA202	50 50 25	CA702 CA802 CA202	50 50 25
Internal Jumper	2 pole CA722/2 3 pole CA722/3 4 pole CA722/4 10 pole CA722/10 100 pole CA722/100	100 100 100 10 10	2 pole CA722/2 3 pole CA722/3 4 pole CA722/4 10 pole CA722/10 100 pole CA722/100	100 100 100 10 10
Insulated Internal Jumper	2 pole CA742/2 3 pole CA742/3 4 pole CA742/4 10 pole CA742/10 100 pole CA742/100	100 100 100 10 10	2 pole CA742/2 3 pole CA742/3 4 pole CA742/4 10 pole CA742/10 100 pole CA742/100	100 100 100 10 10
External Jumper	2 pole CA714/2 3 pole CA714/3 4 pole CA714/4 10 pole CA714/10	100 50 50 20	2 pole CA714/2 3 pole CA714/3 4 pole CA714/4 10 pole CA714/10	100 50 50 20
Test Socket	CA707/TS/01	100	CA707/TS/01	100
Marking Tag	MT6	1 Pk. (100 tags)	MT6	1 Pk. (100 tags)

FEED THROUGH DOUBLE LEVEL

CDLG4(I.S)



CDLG4



CDLG2.5

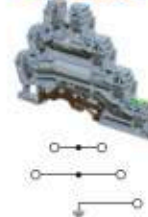

Dimensions & Weight

Width	6 mm	6 mm	6 mm
Length	57.0 mm	57.0 mm	71.0 mm
Height w DIN Rail	35 x 7.5 mm 35 x 15 mm	59.5 mm 67.2 mm	59.5 mm 67.2 mm
Weight per piece	22.2 g	20.6 g	20.2 g

Technical Data/Ratings

Approvals						
Wire Size (solid / stranded)	24-10 AWG	0.2-4 mm ²	24-10 AWG	0.2-4 mm ²	24-12 AWG	0.2-2.5 mm ²
Voltage Rating	150 V	500 V AC/DC	150 V	500 V AC/DC	300 V	500 V
Current Rating	-	-	32 A (upper level)	32 A	24 A	24 A
Torque	4.5 lb-in	0.5 Nm	4.5 lb-in	0.5 Nm	4.5 lb-in	0.4 Nm
Insulation Material	Polyamide 66		Polyamide 66		Polyamide 66	

Installation Instructions

Wire Stripping Length	8 mm	8 mm	9 mm
Screwdriver	Flat Head 0.6 x 3.5 mm	Flat Head 0.6 x 3.5 mm	Flat Head 0.5 x 3.0 mm

Terminal Blocks

	Cat. No.	Std. Pk.	Cat. No.	Std. Pk.	Cat. No.	Std. Pk.
Yellow/Green	CDLG4(I.S)	100	CDLG4	100	CDLG2.5	100

Accessories

	Cat. No.	Std. Pk.	Cat. No.	Std. Pk.	Cat. No.	Std. Pk.	
End Plate	EPCDL4UN	50	EPCDL4UN	50	EPCDLG2.5	50	
Separator Plate	SPCDL4U	100	SPCDL4U	100	SPCDLG2.5	100	
DIN Rail	2511120 CA701-15/S 2511160	20 20 10	2511120 CA701-15/S 2511160	20 20 10	2511120 CA701-15/S 2511160	20 20 10	
End Stop	CA702 CA802 CA202	50 50 25	CA702 CA802 CA202	50 50 25	CA702 CA802 CA202	50 50 25	
Internal Jumper	2 pole 3 pole 4 pole 10 pole 100 pole	CA722/2 CA722/3 CA722/4 CA722/10 CA722/100	100 100 50 10 10	CA722/2 CA722/3 CA722/4 CA722/10 CA722/100	100 100 50 10 10	CA627/2 CA627/3 CA627/4 CA627/10 -	100 100 100 10 -
Insulated Internal Jumper	2 pole 3 pole 4 pole 10 pole 100 pole	CA742/2 CA742/3 CA742/4 CA742/10 CA742/100	100 100 100 10 10	CA742/2 CA742/3 CA742/4 CA742/10 CA742/100	100 100 100 10 10	- - - - -	- - - - -
External Jumper	2 pole 3 pole 4 pole 10 pole	CA714/2 CA714/3 CA714/4 CA714/10	100 50 50 20	CA714/2 CA714/3 CA714/4 CA714/10	100 50 50 20	CA715/2 CA715/3 CA715/4 CA715/10	100 100 100 20
Test Socket	CA707/TS/01	100	CA707/TS/01	100	CA707/TS/01	100	
Marking Tag	MT6	1 Pk. (100 tags)	MT6	1 Pk. (100 tags)	MT2G	1 Pk. (100 tags)	

DOUBLE LEVEL

SCREW TERMINAL BLOCKS

HIGHLIGHTS

FEATURES

- Top Level is offset by half terminal width from lower level
- Offset allows better access to both levels even when fully wired
- Different Endplates for front and back side guarantee flush mounting to neighboring terminal blocks or end stops (EPODL4U and EP1ODL4U)

APPLICATIONS

- High density wiring applications

FEED THROUGH OFFSET DOUBLE LEVEL

ODL4U



Dimensions & Weight

Width	6 mm
Length	68 mm
Height w/ DIN Rail	35 x 7.5 mm 35 x 15 mm
Weight per piece	14.5 g

Technical Data/Ratings

Approvals		
Wire Size (solid / stranded)	22-10 AWG	0.2-4 mm ²
Voltage Rating	600 V	800 VAC/DC
Current Rating	35 A	32 A
Torque	7 lb-in	0.5 Nm
Insulation Material	Polyamide 66	

Installation Instructions

Wire Stripping Length	9 mm
Screwdriver	Flat Head 0.6 x 3.5 mm

Terminal Blocks

Color	Code	Cat. No.	Std. Pk.
Grey (standard)		ODL4U	100
Red	R	ODL4U/R	100
Blue	BU	ODL4U/BU	100
Black	BL	ODL4U/BL	100
Orange	O	ODL4U/O	100
Green	G	ODL4U/G	100
Yellow	Y	ODL4U/Y	100
White	W	ODL4U/W	100

Accessories

Accessory	Quantity	Cat. No.	Std. Pk.
End Plate		EPODL4U (Front)	50
		EP1ODL4U (Back)	50
Separator Plate		SPCDL4U	100
DIN Rail		2511120	20
		CA701-15/S	20
		2511160	10
End Stop		CA702	50
		CA802	50
		CA202	25
Internal Jumper	2 pole	CA727/2	100
	3 pole	CA727/3	100
	4 pole	CA727/4	100
	10 pole	CA727/10	10
	100 pole	CA727/100	10
Insulated Internal Jumper	2 pole	CA747/2	100
	3 pole	CA747/3	100
	4 pole	CA747/4	100
	10 pole	CA747/10	10
	100 pole	CA747/100	10
External Jumper	2 pole	CA714/2	100
	3 pole	CA714/3	100
	4 pole	CA714/4	100
	10 pole	CA714/10	20
Test Socket		CA707/TS/01	
Marking Tag		MT6	1 Pk. (100 tags)

ODL4U
(without End Plates)



ODL4U
(with End Plates)

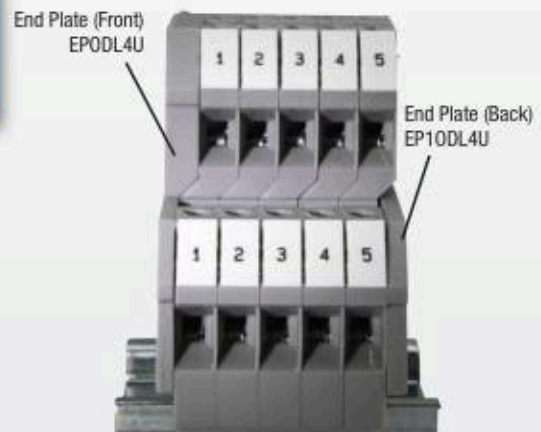

ODL2.5



ODL2.5(I.S)



ODLG2.5



ODLG2.5(I.S)



Dimensions & Weight

Width	5 mm	5 mm	5 mm	5 mm
Length	62.0 mm	62.0 mm	62.0 mm	62.0 mm
Height w DIN Rail	35 x 7.5 mm 35 x 15 mm	63.0 mm 70.5 mm	63.0 mm 70.5 mm	63.0 mm 70.5 mm
Weight per piece	13.0 g	14.2 g	15.3 g	17.0 g

Technical Data/Ratings

Approvals	UL IEC 60947-7-1		UL IEC 60947-7-1		UL IEC 60947-7-1		UL IEC 60947-7-1	
Wire Size (solid / stranded)	24-12 AWG	0.2-2.5 mm ²	24-12 AWG	0.2-2.5 mm ²	24-12 AWG	0.2-2.5 mm ²	24-12 AWG	0.2-2.5 mm ²
Voltage Rating	300 V	800 V AC/DC	300 V	800 V AC/DC	300 V	800 V AC/DC	300 V	800 V AC/DC
Current Rating	25 A	24 A	25 A	24 A	25 A	24 A	24 A	24 A
Torque	4.5 lb-in	0.4 Nm	4.5 lb-in	0.4 Nm	4.5 lb-in	0.4 Nm	4.5 lb-in	0.4 Nm
Insulation Material	Polyamide 66		Polyamide 66		Polyamide 66		Polyamide 66	

Installation Instructions

Wire Stripping Length	8 mm	8 mm	8 mm	8 mm
Screwdriver	Flat Head 0.6 x 3.5 mm	Flat Head 0.6 x 3.5 mm	Flat Head 0.6 x 3.5 mm	Flat Head 0.6 x 3.5 mm

Terminal Blocks

	Cat. No.	Std. Pk.	Cat. No.	Std. Pk.	Cat. No.	Std. Pk.	Cat. No.	Std. Pk.
Grey Stackable Clip-on	ODL2.5	50	ODL2.5(I.S)	50	ODLG2.5	50	ODLG2.5(I.S)	50
	ODL2.5A	50	ODL2.5A(I.S)	50	ODLG2.5A	50	ODLG2.5A(I.S)	50

Accessories

	Cat. No.	Std. Pk.	Cat. No.	Std. Pk.	Cat. No.	Std. Pk.	Cat. No.	Std. Pk.
End Plate	EP0DL2.5	50	EP0DL2.5	50	EP0DL2.5	50	EP0DL2.5	50
Front Side	EP10DL2.5	50	EP10DL2.5	50	EP10DL2.5	50	EP10DL2.5	50
Back Side								
DIN Rail	2511120	20	2511120	20	2511120	20	2511120	20
	CA701-15/S	20	CA701-15/S	20	CA701-15/S	20	CA701-15/S	20
End Stop	CA702	50	CA702	50	CA702	50	CA702	50
	CA802	50	CA802	50	CA802	50	CA802	50
	CA202	25	CA202	25	CA202	25	CA202	25
Shorting Link/ Jumpers	2 pole	JX2.5/2	100	JX2.5/2	100	JX2.5/2	100	JX2.5/2
	3 pole	JX2.5/3	50	JX2.5/3	50	JX2.5/3	50	JX2.5/3
	4 pole	JX2.5/4	50	JX2.5/4	50	JX2.5/4	50	JX2.5/4
	5 pole	JX2.5/5	50	JX2.5/5	50	JX2.5/5	50	JX2.5/5
	6 pole	JX2.5/6	10	JX2.5/6	10	JX2.5/6	10	JX2.5/6
	7 pole	JX2.5/7	10	JX2.5/7	10	JX2.5/7	10	JX2.5/7
	8 pole	JX2.5/8	10	JX2.5/8	10	JX2.5/8	10	JX2.5/8
	10 pole	JX2.5/10	10	JX2.5/10	10	JX2.5/10	10	JX2.5/10
Marking Tag	MT5	1 Pk. (100 tags)	MT5	1 Pk. (100 tags)	MT5	1 Pk. (100 tags)	MT5	1 Pk. (100 tags)

TRIPLE LEVEL

SCREW TERMINAL BLOCKS

FEED THROUGH TRIPLE LEVEL

HIGHLIGHTS

FEATURES

- 3 Feed through levels
- Marking Tag space on all 3 levels
- Independent Levels and internally shorted version **CTL2.5U(I.S)**
- LED versions to show switching indication in various voltages - **CTL2.5U(L)/XX**
- 3 Level terminal with additional grounding level **CTLG2.5**

APPLICATIONS

- Control Systems with sensor applications
- Actuator applications
- Motor applications
- Applications with high wire density

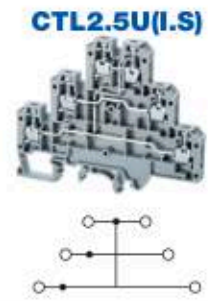
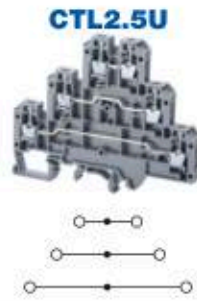

Dimensions & Weight

	CTL2.5U	CTL2.5U-H	CTL2.5U(I.S)
Width	6 mm	6 mm	6 mm
Length	84.0 mm	61.0 mm	84.0 mm
Height w DIN Rail	35 x 7.5 mm 35 x 15 mm	68.0 mm 75.6 mm	68.0 mm 75.6 mm
Weight per piece	20.0 g	21.0 g	21.0 g

Technical Data/Ratings

Approvals						
Wire Size (solid / stranded)	22-12 AWG	0.2-2.5 mm ²	22-12 AWG	0.2-2.5 mm ²	22-12 AWG	0.2-2.5 mm ²
Voltage Rating	300 V	500 V AC/DC	300 V	500 V AC/DC	150 V	500 V AC/DC
Current Rating	25 A	24 A	25 A	24 A	25 A	24 A
Torque	4.5 lb-in	0.4 Nm	4.5 lb-in	0.4 Nm	4.5 lb-in	0.4 Nm
Insulation Material	Polyamide 66		Polyamide 66		Polyamide 66	

Installation Instructions

Wire Stripping Length	9 mm	9 mm	9 mm
Screwdriver	Flat Head 0.5 x 3.0 mm	Flat Head 0.5 x 3.0 mm	Flat Head 0.5 x 3.0 mm

Terminal Blocks

	Cat. No.	Std. Pk.	Cat. No.	Std. Pk.	Cat. No.	Std. Pk.
Grey (standard)	CTL2.5U	50	CTL2.5U-H	50	CTL2.5U(I.S)	50
Red R	CTL2.5U/R	50	CTL2.5U-H/R	50	CTL2.5U(I.S)/R	50
Blue BU	CTL2.5U/BU	50	CTL2.5U-H/BU	50	CTL2.5U(I.S)/BU	50
Black BL	CTL2.5U/BL	50	CTL2.5U-H/BL	50	CTL2.5U(I.S)/BL	50
Orange O	CTL2.5U/O	50	CTL2.5U-H/O	50	CTL2.5U(I.S)/O	50
Green G	CTL2.5U/G	50	CTL2.5U-H/G	50	CTL2.5U(I.S)/G	50
Yellow Y	CTL2.5U/Y	50	CTL2.5U-H/Y	50	CTL2.5U(I.S)/Y	50
White W	CTL2.5U/W	50	CTL2.5U-H/W	50	CTL2.5U(I.S)/W	50

Accessories

	Cat. No.	Std. Pk.	Cat. No.	Std. Pk.	Cat. No.	Std. Pk.
End Plate	EPCTL2.5U	50	EPCTL2.5U-H	50	EPCTL2.5U	50
DIN Rail	2511120 CA701-15/S 2511160	20 20 10	2511120 CA701-15/S 2511160	20 20 10	2511120 CA701-15/S 2511160	20 20 10
End Stop	CA702 CA802 CA202	50 50 25	CA702 CA802 CA202	50 50 25	CA702 CA802 CA202	50 50 25
Internal Jumper	2 pole CA722/2 3 pole CA722/3 4 pole CA722/4 10 pole CA722/10 100 pole CA722/100	100 100 100 10 10	2 pole CA722/2 3 pole CA722/3 4 pole CA722/4 10 pole CA722/10 100 pole CA722/100	100 100 100 10 10	2 pole CA722/2 3 pole CA722/3 4 pole CA722/4 10 pole CA722/10 100 pole CA722/100	100 100 100 10 10
External Jumper	2 pole CA715/2 3 pole CA715/3 4 pole CA715/4 10 pole CA715/10	100 100 100 20	2 pole CA715/2 3 pole CA715/3 4 pole CA715/4 10 pole CA715/10	100 100 100 20	2 pole CA715/2 3 pole CA715/3 4 pole CA715/4 10 pole CA715/10	100 100 100 20
Test Socket	CA707/TS/01	100	CA707/TS/01	100	CA707/TS/01	100
Marking Tag	MT2	1 Pk. (100 tags)	MT2	1 Pk. (100 tags)	MT2	1 Pk. (100 tags)

CTL2.5U-H(L)/XX



CTL2.5U(L)/XX

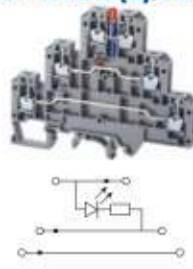

CTL2.5UH(I.S)D2



CTLG2.5



Dimensions & Weight

Width	6 mm		6 mm		6 mm		6 mm	
Length	61.0 mm		84.0 mm		61.0 mm		87.5 mm	
Height w/ DIN Rail	35 x 7.5 mm 35 x 15 mm	68.0 mm 75.6 mm	68.0 mm 75.6 mm	68.0 mm 75.6 mm	68.0 mm 75.6 mm	66.0 mm 74.0 mm	66.0 mm 74.0 mm	27.4 g
Weight per piece	21.0 g		21.0 g		15.1 g		27.4 g	

Technical Data/Ratings

Approvals								
Wire Size (solid / stranded)	22-12 AWG	0.2-2.5 mm ²	22-12 AWG	0.2-2.5 mm ²	22-12 AWG	0.2-2.5 mm ²	24-12 AWG	0.2-2.5 mm ²
Voltage Rating	300 V	500 V AC/DC	300 V	500 V AC/DC	150 V	500 V AC/DC	300 V	440 V
Current Rating	25 A	24 A	25 A	24 A	25 A	24 A	24 A	24 A
Torque	4.5 lb-in	0.4 Nm	4.5 lb-in	0.4 Nm	4.5 lb-in	0.4 Nm	4.5 lb-in	0.4 Nm
Insulation Material	Polyamide 66		Polyamide 66		Polyamide 66		Polyamide 66	

Installation Instructions

Wire Stripping Length	9 mm		9 mm		9 mm		9 mm	
Screwdriver	Flat Head 0.5 x 3.0 mm		Flat Head 0.5 x 3.0 mm		Flat Head 0.5 x 3.0 mm		Flat Head 0.6 x 3.5 mm	

Terminal Blocks

	Cat. No.	Std. Pk.	Cat. No.	Std. Pk.	Cat. No.	Std. Pk.	Cat. No.	Std. Pk.
Grey					CTL2.5UH(I.S)D2	50	CTLG2.5	100
LED Voltage 12 V	CTL2.5U-H(L)/12	50	CTL2.5U(L)/12	50			Yellow/Green	
LED Voltage 24 V	CTL2.5U-H(L)/24	50	CTL2.5U(L)/24	50				
LED Voltage 48 V	CTL2.5U-H(L)/48	50	CTL2.5U(L)/48	50				
LED Voltage 110 V	CTL2.5U-H(L)/110	50	CTL2.5U(L)/110	50				
LED Voltage 220 V	CTL2.5U-H(L)/220	50	CTL2.5U(L)/220	50				

Accessories

	Cat. No.	Std. Pk.	Cat. No.	Std. Pk.	Cat. No.	Std. Pk.	Cat. No.	Std. Pk.
End Plate	EPCTL2.5U-H	50	EPCTL2.5U	50	EPCTL2.5U-H	50	EPCTLG2.5	50
DIN Rail	2511120 CA701-15/S 2511160	20 20 10	2511120 CA701-15/S 2511160	20 20 10	2511120 CA701-15/S 2511160	20 20 10	2511120 CA701-15/S 2511160	20 20 10
End Stop	CA702 CA802 CA202	50 50 25	CA702 CA802 CA202	50 50 25	CA702 CA802 CA202	50 50 25	CA702 CA802 CA202	50 50 25
Internal Jumper	2 pole 3 pole 4 pole 10 pole 100 pole	CA722/2 CA722/3 CA722/4 CA722/10 CA722/100	100 100 100 10 10	CA722/2 CA722/3 CA722/4 CA722/10 CA722/100	100 100 100 10 10	CA722/2 CA722/3 CA722/4 CA722/10 CA722/100	CA627/2 CA627/3 CA627/4 CA627/10 -	100 100 100 10 -
External Jumper	2 pole 3 pole 4 pole 10 pole	CA715/2 CA715/3 CA715/4 CA715/10	100 100 100 20	CA715/2 CA715/3 CA715/4 CA715/10	100 100 100 20	CA715/2 CA715/3 CA715/4 CA715/10	CA715/2 CA715/3 CA715/4 CA715/10	100 100 100 20
Test Socket	CA707/TS/01	100	CA707/TS/01	100	CA707/TS/01	100	CA707/TS/01	100
Marking Tag	MT2	1 Pk. (100 tags)	MT2	1 Pk. (100 tags)	MT2	1 Pk. (100 tags)	MT2G	1 Pk. (100 tags)

HIGHLIGHTS

FEATURES

- Yellow/Green color code as per industry standard
- Clamp mechanically on Rail by tightening middle screw
- Rail serves as grounding busbar to feed ground potential to all other grounding terminals
- **CGT4N, CGT6N, CGT10N and CGT16N** have same profile as respective feed through blocks
- **CGT4U, CGT10U, and CGT35U** mount on both 35mm and 32mm DIN-Rail

APPLICATIONS

- Grounding Applications

CGT4U



CGT4N



CGT6N



Dimensions & Weight

	CGT4U	CGT4N	CGT6N
Width	6 mm	6 mm	8 mm
Length	43 mm	54.2 mm	54.5 mm
Height w DIN Rail	35 x 7.5 mm 35 x 15 mm	49.5 mm 56.7 mm	48.2 mm 55.8 mm
Weight per piece	21.5 g	22.0 g	27.0 g

Technical Data/Ratings

Approvals						
Wire Size (solid / stranded)	22-10 AWG / 0.2-4 mm ²		22-10 AWG / 0.2-4 mm ²		22-8 AWG / 0.2-6 mm ²	
Voltage Rating	600V / 800 VAC/DC		600V / 1000 VAC/DC		600V / 1000 VAC/DC	
Current Rating	-		-		-	
Torque	7.0 lb-in / 0.5 Nm		7 lb-in / 0.5 Nm		14 lb-in / 1.6 Nm	
Insulation Material	Polyamide 66		Polyamide 66		Polyamide 66	

Installation Instructions

	CGT4U	CGT4N	CGT6N
Wire Stripping Length	8 mm	8 mm	9 mm
Screwdriver	Flat Head 0.6 x 3.5 mm	Flat Head 0.6 x 3.5 mm	Flat Head 0.8 x 4.0 mm

Terminal Blocks

	Cat. No.	Std. Pk.	Cat. No.	Std. Pk.	Cat. No.	Std. Pk.
Yellow/Green	CGT4U	50	CGT4N	50	CGT6N	50

Accessories

	Cat. No.	Std. Pk.	Cat. No.	Std. Pk.	Cat. No.	Std. Pk.
End Plate	EPCGT4U/Y	50	-	-	-	-
DIN Rail	2511120	20	2511120	20	2511120	20
	CA701-15/S	20	CA701-15/S	20	CA701-15/S	20
	2511160	10	2511160	10	2511160	10
Marking Tag	MT6	1 Pk. (100 tags)	MT6	1 Pk. (100 tags)	MT8	1 Pk. (100 tags)



Assembly example for single phase 3 wire circuits.

FUSE BLOCKS

SCREW TERMINAL BLOCKS

FUSE BLOCKS, 5 x 20 and 5 x 25 mm

HIGHLIGHTS

FEATURES

- CF4U Series accepts 5x20mm/ 5x25mm fuse types
- Completely enclosed, no endplates
- CF4U(L) version with LED for blown fuse indication
- Large marking area
- No polarity required
- Blocks can be used for AC & DC Voltages

APPLICATIONS

- Control systems with fuse protection



Dimensions & Weight

	CF4U	CF4U(L)/6-60V	CF4U(L)/110-240V
Width	8 mm	8 mm	8 mm
Length	57.0 mm	57.0 mm	57.0 mm
Height w DIN Rail	35 x 7.5 mm 35 x 15 mm	50.3 mm 57.6 mm	50.3 mm 57.6 mm
Weight per piece	14.8 g	15.4 g	15.4 g

Technical Data/Ratings

Approvals	CF4U		CF4U(L)/6-60V		CF4U(L)/110-240V	
	CE	UL E220514	UL E220514	UL E220514	UL E220514	UL E220514
Wire Size (solid / stranded)	22-10 AWG	0.2-4 mm ²	22-10 AWG	0.2-4 mm ²	22-10 AWG	0.2-4 mm ²
Voltage Rating	600 V	800 V AC/DC	600 V	800 V AC/DC	600 V	800 V AC/DC
Current Rating	10 A	6.3 A	10 A	6.3 A	10 A	6.3 A
Torque	7 lb-in	0.5 Nm	7 lb-in	0.5 Nm	7 lb-in	0.5 Nm
Insulation Material	Polyamide 66					

Fuse Specifications

	CF4U	CF4U(L)/6-60V	CF4U(L)/110-240V
Fuse Type	5x20 mm / 5 x 25 mm	5x20 mm / 5 x 25 mm	5x20 mm / 5 x 25 mm
LED Indicator Voltage	-	6-60V AC/DC	110-240V AC/DC

Installation Instructions

	CF4U	CF4U(L)/6-60V	CF4U(L)/110-240V
Wire Stripping Length	9.5 mm	9.5 mm	9.5 mm
Screwdriver	Flat Head 0.6 x 3.5 mm	Flat Head 0.6 x 3.5 mm	Flat Head 0.6 x 3.5 mm

Terminal Blocks

	Cat. No.	Std. Pk.	Cat. No.	Std. Pk.	Cat. No.	Std. Pk.
Grey (standard)	CF4U	50	CF4U(L)/6-60V	50	CF4U(L)/110-240V	50
Blue BU	CF4U/BU	50	CF4U(L)/6-60V/BU	50	CF4U(L)/110-240V/BU	50
Black BL	CF4U/BL	50	CF4U(L)/6-60V/BL	50	CF4U(L)/110-240V/BL	50

Accessories

	Cat. No.	Std. Pk.	Cat. No.	Std. Pk.	Cat. No.	Std. Pk.
DIN Rail	2511120	20	2511120	20	2511120	20
	CA701-15/S	20	CA701-15/S	20	CA701-15/S	20
	2511160	10	2511160	10	2511160	10
External Jumper	CA711/2	100	CA711/2	100	CA711/2	100
	CA711/3	50	CA711/3	50	CA711/3	50
	CA711/4	50	CA711/4	50	CA711/4	50
	CA711/10	20	CA711/10	20	CA711/10	20
	CA711/10	20	CA711/10	20	CA711/10	20
Marking Tag	MT8	1 Pk. (100 tags)	MT8	1 Pk. (100 tags)	MT8	1 Pk. (100 tags)
	MT6	1 Pk. (100 tags)	MT6	1 Pk. (100 tags)	MT6	1 Pk. (100 tags)

Fuses 5 x 20 mm



Current Rating	Slow Blow Cat. No	Fast Blow Cat. No
0.1A	0.1M5x20T	0.1M5x20F
0.2A	0.2M5x20T	0.2M5x20F
0.5A	0.5M5x20T	0.5M5x20F
1.0A	1.0M5x20T	1.0M5x20F
2.0A	2.0M5x20T	2.0M5x20F
4.0A	4.0M5x20T	4.0M5x20F
5.0A	5.0M5x20T	5.0M5x20F
6.3A	6.3M5x20T	6.3M5x20F
8.0A	8.0M5x20T	8.0M5x20F
10.0A	10.0M5x20T	10.0M5x20F

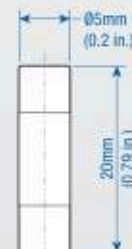

FUSE BLOCKS, 5 x 20 and 5 x 25 mm

CF4SP

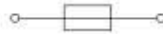

CF4SP(L)/6-60V

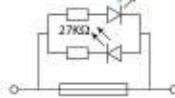

CF4SP(L)/110-240V

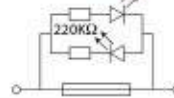

Dimensions & Weight

Width	6 mm	6 mm	6 mm
Length	58.5 mm	58.5 mm	58.5 mm
Height w/ DIN Rail	35 x 7.5 mm 35 x 15 mm	70.0 mm 77.5 mm	70.0 mm 77.5 mm
Weight per piece	16.9 g	17.4 g	17.4 g

Technical Data/Ratings

Approvals						
Wire Size (solid / stranded)	24-10 AWG	0.2-4 mm ²	24-10 AWG	0.2-4 mm ²	24-10 AWG	0.2-4 mm ²
Voltage Rating	600 V	1000 V AC/DC	600 V	1000 V AC/DC	600 V	1000 V AC/DC
Current Rating	10 A	10 A	10 A	10 A	10 A	10 A
Torque	4.5 lb-in	0.5 Nm	4.5 lb-in	0.5 Nm	4.5 lb-in	0.5 Nm
Insulation Material	Polyamide 66		Polyamide 66		Polyamide 66	

Fuse Specifications

Fuse Type	5x20 mm / 5 x 25 mm	5x20 mm / 5 x 25 mm	5x20 mm / 5 x 25 mm
LED Indicator Voltage	-	6-60V AC/DC	110-240V AC/DC

Installation Instructions

Wire Stripping Length	8 mm	8 mm	8 mm
Screwdriver	Flat Head 0.6 x 3.5 mm	Flat Head 0.6 x 3.5 mm	Flat Head 0.6 x 3.5 mm

Terminal Blocks

	Cat. No.	Std. Pk.	Cat. No.	Std. Pk.	Cat. No.	Std. Pk.
Grey (standard)	CF4SP	50	CF4SP(L)/6-60V	50	CF4SP(L)/110-240V	50
Blue BU	CF4SP/BU	50	CF4SP(L)/6-60V/BU	50	CF4SP(L)/110-240V/BU50	
Black BL	CF4SP/BL	50	CF4SP(L)/6-60V/BL	50	CF4SP(L)/110-240V/BL50	

Accessories

	Cat. No.	Std. Pk.	Cat. No.	Std. Pk.	Cat. No.	Std. Pk.
DIN Rail 	2511120	20	2511120	20	2511120	20
	CA701-15/S	20	CA701-15/S	20	CA701-15/S	20
	2511160	10	2511160	10	2511160	10
Internal Jumper 	2 pole CA722/2	100	2 pole CA722/2	100	2 pole CA722/2	100
	3 pole CA722/3	100	3 pole CA722/3	100	3 pole CA722/3	100
	4 pole CA722/4	100	4 pole CA722/4	100	4 pole CA722/4	100
	10 pole CA722/10	10	10 pole CA722/10	10	10 pole CA722/10	10
	100 pole CA722/100	10	100 pole CA722/100	10	100 pole CA722/100	10
Insulated Internal Jumper 	2 pole CA742/2	100	2 pole CA742/2	100	2 pole CA742/2	100
	3 pole CA742/3	100	3 pole CA742/3	100	3 pole CA742/3	100
	4 pole CA742/4	100	4 pole CA742/4	100	4 pole CA742/4	100
	10 pole CA742/10	10	10 pole CA742/10	10	10 pole CA742/10	10
	100 pole CA742/100	10	100 pole CA742/100	10	100 pole CA742/100	10
External Jumper 	2 pole CA714/2	100	2 pole CA714/2	100	2 pole CA714/2	100
	3 pole CA714/3	100	3 pole CA714/3	100	3 pole CA714/3	100
	4 pole CA714/4	100	4 pole CA714/4	100	4 pole CA714/4	100
	10 pole CA714/10	20	10 pole CA714/10	20	10 pole CA714/10	20
	Marking Tag On Terminal On Fuse Carrier 	MT6 MT6	1 Pk. (100 tags) 1 Pk. (100 tags)	MT6 MT6	1 Pk. (100 tags) 1 Pk. (100 tags)	MT6 MT6

HIGHLIGHTS

FEATURES

- CF4SP Series accepts 5x20mm fuse types
- 6mm wide, compact design
- Internal shorting channel
- Completely enclosed, no endplates
- CF4SP(L) version with LED for blown fuse indication
- No polarity required

APPLICATIONS

- Control systems with fuse protection
- Control Circuits with alternating configuration with (CF4SPFT, CKT4SP, etc...)

CF4SPFT



Feed Through Terminal
Same Profile as CF4SP

Technical Data/Ratings

Approvals		
Wire Size (solid / stranded)	24-10 AWG	0.2-4 mm ²
Voltage Rating	600 V	1000 V
Current Rating	30 A	32 A
Torque	4.5 lb-in	0.5 Nm
Insulation Material	Polyamide 66	

FUSE BLOCKS

SCREW TERMINAL BLOCKS

DOUBLE LEVEL FUSE BLOCKS, 5 x 20 / 5 x 25 mm

HIGHLIGHTS

FEATURES

- Top Level fuse link for 5x20mm/ 5x25mm fuse types
- Bottom Level Feed through terminal
- **DDFL4U(E)** version with LED for blown fuse indication in various voltages
- Blocks can be used in AC & DC applications

APPLICATIONS

- Tight space fuse applications
- No need for additional Feed through terminal



Dimensions & Weight

	DDFL4U	DDFL4U(E)/XX
Width	8 mm	8 mm
Length	88 mm	88 mm
Height w DIN Rail 35 x 7.5 mm 35 x 15 mm	67.4 mm 74.3 mm	67.4 mm 74.3 mm
Weight per piece	28.0 g	27.0 g

Technical Data/Ratings

Approvals				
Wire Size (solid / stranded)	22-10 AWG	0.2-4 mm ²	22-10 AWG	0.2-4 mm ²
Voltage Rating	600 V	800 V AC/DC	600 V	800 V AC/DC
Current Rating (top)	6.3 A	6.3 A	6.3 A	6.3 A
Current Rating (bottom)	35 A	32 A	35 A	32 A
Torque	7 lb-in	0.5 Nm	7 lb-in	0.5 Nm
Insulation Material	Polyamide 66		Polyamide 66	

Fuse Specifications

	DDFL4U	DDFL4U(E)/XX
Fuse Type	5x20 mm / 5 x 25 mm	5x20 mm / 5 x 25 mm
LED Indicator Voltage	-	24V, 48V, 110V, 220V, 440V

Installation Instructions

	DDFL4U	DDFL4U(E)/XX
Wire Stripping Length	9.5 mm	9.5 mm
Screwdriver	Flat Head 0.6 x 3.5 mm	Flat Head 0.6 x 3.5 mm

Terminal Blocks

	Cat. No.	Std. Pk.	Cat. No.	Std. Pk.
Grey	DDFL4U	20	DDFL4U(E)/24	20
LED Voltage 24V AC/DC			DDFL4U(E)/48	20
LED Voltage 48V AC/DC			DDFL4U(E)/110	20
LED Voltage 110V AC/DC			DDFL4U(E)/220	20
LED Voltage 220V AC/DC			DDFL4U(E)/440	20
LED Voltage 440V AC				

Accessories

	Cat. No.	Std. Pk.	Cat. No.	Std. Pk.
End Plate	EPDDL4U	50	EPDDL4U	50
DIN Rail	2511120	20	2511120	20
	CA701-15/S	20	CA701-15/S	20
	2511160	10	2511160	10
End Stop	CA702	50	CA702	50
	CA802	50	CA802	50
	CA202	25	CA202	25
Internal Jumper	2 pole 3 pole 4 pole 10 pole	CA729/2 CA729/3 CA729/4 CA729/10	100 50 50 10	CA729/2 CA729/3 CA729/4 CA729/10
Insulated Internal Jumper	2 pole 3 pole 4 pole 10 pole	CA749/2 CA749/3 CA749/4 CA749/10	100 50 50 10	CA749/2 CA749/3 CA749/4 CA749/10
External Jumper	2 pole 3 pole 4 pole 10 pole	CA711/2 CA711/3 CA711/4 CA711/10	100 50 50 20	CA711/2 CA711/3 CA711/4 CA711/10
Marking Tag	on terminal on lever	MT8 MT2	1 Pk. (100 tags) 1 Pk. (100 tags)	MT8 MT2
				1 Pk. (100 tags) 1 Pk. (100 tags)

DOUBLE LEVEL FUSE BLOCKS, 5 x 20 / 5 x 25 mm
WITH 2 CONNECTION POINTS

DDFL4ULR

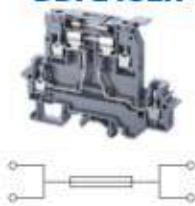

DDFL4U(E)LR/XX

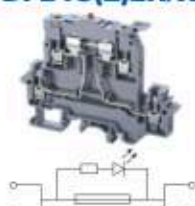

Dimensions & Weight

Width	8 mm	8 mm
Length	88 mm	88 mm
Height w DIN Rail	35 x 7.5 mm 35 x 15 mm	67.4 mm 74.3 mm
Weight per piece	24.5 g	27.0 g

Technical Data/Ratings

Approvals				
Wire Size (solid / stranded)	22-10 AWG	0.2-4 mm ²	22-10 AWG	0.2-4 mm ²
Voltage Rating	600 V	800 V AC/DC	600 V	800 V AC/DC
Current Rating (top)	6.3 A	6.3 A	6.3 A	6.3 A
Torque	7 lb-in	0.5 Nm	7 lb-in	0.5 Nm
Insulation Material	Polyamide 66		Polyamide 66	

Fuse Specifications

Fuse Type	5x20 mm / 5 x 25 mm	5x20 mm / 5 x 25 mm
LED Indicator Voltage	-	24V, 48V, 110V, 220V, 440V

Installation Instructions

Wire Stripping Length	9.5 mm	9.5 mm
Screwdriver	Flat Head 0.6 x 3.5 mm	Flat Head 0.6 x 3.5 mm

Terminal Blocks

	Cat. No.	Std. Pk.	Cat. No.	Std. Pk.
Grey LED Voltage 24V AC/DC LED Voltage 48V AC/DC LED Voltage 110V AC/DC LED Voltage 220V AC/DC LED Voltage 440V AC	DDFL4ULR	20	DDFL4U(E)LR/24	20
			DDFL4U(E)LR/48	20
			DDFL4U(E)LR/110	20
			DDFL4U(E)LR/220	20
			DDFL4U(E)LR/440	20

Accessories

	Cat. No.	Std. Pk.	Cat. No.	Std. Pk.
End Plate	EPD0FL4U	50	EPD0FL4U	50
DIN Rail	2511120	20	2511120	20
	CA701-15/S	20	CA701-15/S	20
	2511160	10	2511160	10
End Stop	CA702	50	CA702	50
	CA802	50	CA802	50
	CA202	25	CA202	25
Internal Jumper	2 pole CA729/2	100	2 pole CA729/2	100
	3 pole CA729/3	50	3 pole CA729/3	50
	4 pole CA729/4	50	4 pole CA729/4	50
	10 pole CA729/10	10	10 pole CA729/10	10
Insulated Internal Jumper	2 pole CA749/2	100	2 pole CA749/2	100
	3 pole CA749/3	50	3 pole CA749/3	50
	4 pole CA749/4	50	4 pole CA749/4	50
	10 pole CA749/10	10	10 pole CA749/10	10
External Jumper	2 pole CA711/2	100	2 pole CA711/2	100
	3 pole CA711/3	50	3 pole CA711/3	50
	4 pole CA711/4	50	4 pole CA711/4	50
	10 pole CA711/10	20	10 pole CA711/10	20
Marking Tag on terminal on lever	MT8	1 Pk. (100 tags)	MT8	1 Pk. (100 tags)
	MT2	1 Pk. (100 tags)	MT2	1 Pk. (100 tags)

HIGHLIGHTS

FEATURES

- Modified version of **DDFL4U** with 2 equipotential
- **DDFL4U(E)** version with LED for blown fuse indication in various voltages
- Blocks can be used in AC & DC applications

APPLICATIONS

- Control Circuits with multi wire fuse application

FUSE BLOCKS

SCREW TERMINAL BLOCKS

FUSE BLOCKS, 1/4" x 1" and 1/4" x 1 1/4" in.

HIGHLIGHTS

FEATURES

- **CAFL4U** Series accepts 1/4" x 1-1/4" (6.3x32mm) fuse types
- **CAFL4U(L)** versions with LED for blown fuse indication (24V, 48V, 110V, 220V)
- **CAFL4U(N)** version with Neon bulb for blown fuse indication
- Large marking area
- Blocks can be used in AC & DC applications

APPLICATIONS

- Control systems with 1/4" x 1-1/4" fuse protection



Dimensions & Weight

	CAFL4U	CAFL4U(L)/XX	CAFL4U(N)
Width	9 mm	9 mm	9 mm
Length	72 mm	72 mm	72 mm
Height w/ DIN Rail	35 x 7.5 mm 35 x 15 mm	55.3 mm 63.0 mm	55.3 mm 63.0 mm
Weight per piece	20.5 g	20.5 g	20.5 g

Technical Data/Ratings

Approvals	CE		UL US E220514		C SP US 60947-7-3		IEC 60947-7-3	
Wire Size (solid / stranded)	22-10 AWG		0.2-4 mm ²		22-10 AWG		0.2-4 mm ²	
Voltage Rating	600 V		1000 V		600 V		1000 V	
Current Rating	16 A		6.3 A		16 A		6.3 A	
Torque	7 lb-in		0.5 Nm		7 lb-in		0.5 Nm	
Insulation Material	Polyamide 66							

Installation Instructions

Wire Stripping Length	CAFL4U	CAFL4U(L)/XX	CAFL4U(N)
	9.5 mm	9.5 mm	9.5 mm
Screwdriver	Flat Head 0.6 x 3.5 mm		

Fuse Specifications

Fuse Type	CAFL4U	CAFL4U(L)/XX	CAFL4U(N)
	1/4" x 1" (6.3 x 32 mm)	1/4" x 1" (6.3 x 32 mm)	1/4" x 1" (6.3 x 32 mm)
LED/Neon Indicator Voltage	-	24V, 48V, 110V, 220V	110V - 240V

Terminal Blocks

	Cat. No.	Std. Pk.	Cat. No.	Std. Pk.	Cat. No.	Std. Pk.
Grey (standard)	CAFL4U	25	-	-	-	-
Blue BU	CAFL4U/BU	25	-	-	-	-
Black BL	CAFL4U/BL	25	-	-	-	-
LED Voltage 24V AC/DC	-	-	CAFL4U(L)/24	25	-	-
LED Voltage 48V AC/DC	-	-	CAFL4U(L)/48	25	-	-
LED Voltage 110V AC/DC	-	-	CAFL4U(L)/110	25	-	-
LED Voltage 220V AC/DC	-	-	CAFL4U(L)/220	25	-	-
Neon Bulb 110-300V AC/DC	-	-	-	-	CAFL4U(N)	25

Accessories

	Cat. No.	Std. Pk.	Cat. No.	Std. Pk.	Cat. No.	Std. Pk.
End Plate	EPCAF4U	50	EPCAF4U	50	EPCAF4U	50
DIN Rail	2511120	20	2511120	20	2511120	20
	CA701-15/S	20	CA701-15/S	20	CA701-15/S	20
	2511160	10	2511160	10	2511160	10
End Stop	CA702	50	CA702	50	CA702	50
	CA802	50	CA802	50	CA802	50
	CA202	25	CA202	25	CA202	25
External Jumper	CA716/2	50	CA716/2	50	CA716/2	50
2 pole	CA716/3	50	CA716/3	50	CA716/3	50
3 pole	CA716/4	50	CA716/4	50	CA716/4	50
4 pole	CA716/10	20	CA716/10	20	CA716/10	20
10 pole	MT9	1 Pk. (100 tags)	MT9	1 Pk. (100 tags)	MT9	1 Pk. (100 tags)
Marking Tag						

Fuses
1/4" x 1-1/4"
(6.3 x 32mm)



Current Rating	Slow Blow Cat. No	Fast Blow Cat. No	Current Rating	Slow Blow Cat. No	Fast Blow Cat. No
0.1A	0.1M6.3x32T	0.1M6x32F	4.0A	4.0M6.3x32T	4.0M6x32F
0.2A	0.2M6.3x32T	0.2M6x32F	5.0A	5.0M6.3x32T	5.0M6x32F
0.5A	0.5M6.3x32T	0.5M6x32F	6.3A	6.3M6.3x32T	6.3M6x32F
1.0A	1.0M6.3x32T	1.0M6x32F	8.0A	8.0M6.3x32T	8.0M6x32F
2.0A	2.0M6.3x32T	2.0M6x32F	10.0A	10.0M6.3x32T	10.0M6x32F





Dimensions

Width	6 mm	6 mm	6 mm	6 mm
Length	58.5 mm	28 mm	28 mm	28 mm
Height w/ DIN Rail	35 x 7.5 mm 35 x 15 mm	46 mm 53.5 mm	35 mm	35 mm
Weight per piece	10.2 g	3.8 g	3.8 g	4.2 g

Technical Data/Ratings

Approvals							
Wire Size (solid stranded)	0.2-6 mm ² 0.2-4 mm ²	24-10 AWG 0.2-4 mm ²	0.2-4 mm ²	24-10 AWG 0.2-4 mm ²	0.2-4 mm ²	24-10 AWG 0.2-4 mm ²	0.2-4 mm ²
Voltage Rating	1000 V AC/DC	600 V 1000V AC/DC	1000V AC/DC	600 V 1000V AC/DC	1000V AC/DC	600 V 1000V AC/DC	1000V AC/DC
Current Rating	*	1 A 1 A	1 A	10 A 10 A	10 A	10 A 10 A	10 A 10 A
Insulation Material	Polyamide 66	Polyamide 66	Polyamide 66	Polyamide 66	Polyamide 66	Polyamide 66	Polyamide 66

Carrier Specifications

Component Type	Component carrier base	Plug module with diode Diode Type IN4007	Plug module for 5x20 mm fuse	Plug module for 5x20 mm fuse with LED indicator
LED Indicator Voltage	-	-	-	6-60V AC/DC 110-240V AC/DC

Installation Instructions

Wire Stripping Length	8 mm	10 mm	10 mm	10 mm
Screwdriver	Flat Head 0.6 x 3.5 mm	Flat Head 0.6 x 3.5 mm	Flat Head 0.6 x 3.5 mm	Flat Head 0.6 x 3.5 mm

Terminal Blocks

	Cat. No.	Std. Pk.	Cat. No.	Std. Pk.	Cat. No.	Std. Pk.	Cat. No.	Std. Pk.
Grey (standard)	CCC4U	50	CPF	50	CPFL6-60V	50	CPFL110-240V	50

Accessories

	Cat. No.	Std. Pk.	Cat. No.	Std. Pk.	Cat. No.	Std. Pk.	Cat. No.	Std. Pk.
DIN Rail	2511120 CA701-15/S	20 10	-	-	-	-	-	-
End Stop	CA702 CA802 CA103	50 50 50	-	-	-	-	-	-
Internal Jumpers	2 pole 3 pole 4 pole 10 pole 100 pole	CA722/2 CA722/3 CA722/4 CA722/10 CA722/100	100 100 100 10 10	-	-	-	-	-
Marking Tag	MT6	1 Pk. (100 tags)	MT6	1 Pk. (100 tags)	MT6	1 Pk. (100 tags)	MT6	1 Pk. (100 tags)

* Current Rating is based on plug used.

10x38 Midget Fuse Holders



UL
E212627

Pole Configuration	Without Indication	With LED Indication	Fuse Size	Max Voltage & Current		Drawing No.
				IEC	UL	
PCF 10 & PCF 10 LED						
1-pole	002550001	002550011	10x38	690V AC / 32A	600V AC/DC / 30A	1
1-pole+N	002550002	002550012	10x38	690V AC / 32A	600V AC/DC / 30A	1
2-pole	002550003	002550013	10x38	690V AC / 32A	600V AC/DC / 30A	1
3-pole	002550004	002550014	10x38	690V AC / 32A	600V AC/DC / 30A	1
3-pole+N	002550005	002550015	10x38	690V AC / 32A	600V AC/DC / 30A	1
EFD 10 & EFD 10 LED						
▶ 1-pole	002540001	002540011	10x38	690V AC/DC / 32A	600V AC/DC / 30A	2
▶ 1-pole+N	002540002	002540012	10x38	690V AC/DC / 32A	600V AC/DC / 30A	2
▶ 2-pole	002540003	002540013	10x38	690V AC/DC / 32A	600V AC/DC / 30A	2
▶ 3-pole	002540004	002540014	10x38	690V AC/DC / 32A	600V AC/DC / 30A	2
▶ 3-pole+N	002540005	002540015	10x38	690V AC/DC / 32A	600V AC/DC / 30A	2

CC Type and J Type Fuse Holders



UL
E212627

Pole Configuration	Without Indication	With LED Indication	Fuse Size	SCR	UL Rating		Drawing No.
					Voltage/Amp.		
PCF CC & PCF CC LED							
1-pole	002550101	002550111	CC Type	200 kA	600V AC/DC / 30A		1
2-pole	002550103	002550113	CC Type	200 kA	600V AC/DC / 30A		1
3-pole	002550104	002550114	CC Type	200 kA	600V AC/DC / 30A		1
EFD CC & EFD CC LED							
▶ 1-pole	002540101	002540111	CC Type	200 kA	600V AC / 30A		2
▶ 2-pole	002540103	002540113	CC Type	200 kA	600V AC / 30A		2
▶ 3-pole	002540104	002540114	CC Type	200 kA	600V AC / 30A		2
EFD J30 DC & EFD J30 10 DC LED							
▶ 1-pole	002570101	002570111	J-TYPE	200 kA	600V AC/DC / 30A		3
▶ 2-pole	002570103	002570113	J-TYPE	200 kA	600V AC/DC / 30A		3
▶ 3-pole	002570104	002570114	J-TYPE	200 kA	600V AC/DC / 30A		3

PV Type Fuse Holders



UL
E356295

Pole Configuration	Without Indication	With LED Indication	Fuse Size	Max Voltage & Current		Drawing No.
				IEC	UL	
PCF 10 DC & PCF 10 DC LED						
1-pole	002550201	002550211	10x38	1000V DC / 25A	1000V DC / 25A	1
2-pole	002550203	002550213	10x38	1000V DC / 25A	1000V DC / 25A	1
EFH 10 DC & EFH 10 DC LED						
▶ 1-pole	002540201	002540211	10x38	1000V DC / 25A	1000V DC / 25A	2
▶ 2-pole	002540203	002540213	10x38	1000V DC / 25A	1000V DC / 25A	2
EFH 14 DC & EFH 14 DC LED						
▶ 1-pole	002560201	002560211	14x51	1000V DC / 50A	1000V DC / 50A	3
▶ 2-pole	002560203	002560213	14x51	1000V DC / 50A	1000V DC / 50A	3

IEC Type Fuse Holders



UL
E212627

Pole Configuration	Without Indication	With LED Indication	Fuse Size	Max Voltage & Current		Drawing No.
				IEC	UL	
EFD 14 & EFD 14 LED						
▶ 1-pole	002560001	002560011	14x51	690V AC / 50A	600V AC/DC / 50A	3
▶ 1-pole+N	002560002	002560012	14x51	690V AC / 50A	600V AC/DC / 50A	3
▶ 2-pole	002560003	002560013	14x51	690V AC / 50A	600V AC/DC / 50A	3
▶ 3-pole	002560004	002560014	14x51	690V AC / 50A	600V AC/DC / 50A	3
▶ 3-pole+N	002560005	002560015	14x51	690V AC / 50A	600V AC/DC / 50A	3
EFD 22 & EFD 22 LED						
▶ 1-pole	002570001	002570011	22x58	690V AC / 100A	600V AC/DC / 100A	4
▶ 1-pole+N	002570002	002570012	22x58	690V AC / 100A	600V AC/DC / 100A	4
▶ 2-pole	002570003	002570013	22x58	690V AC / 100A	600V AC/DC / 100A	4
▶ 3-pole	002570004	002570014	22x58	690V AC / 100A	600V AC/DC / 100A	4
▶ 3-pole+N	002570005	002570015	22x58	690V AC / 100A	600V AC/DC / 100A	4

FUSE HOLDERS, 10 x 38 mm and CC Type

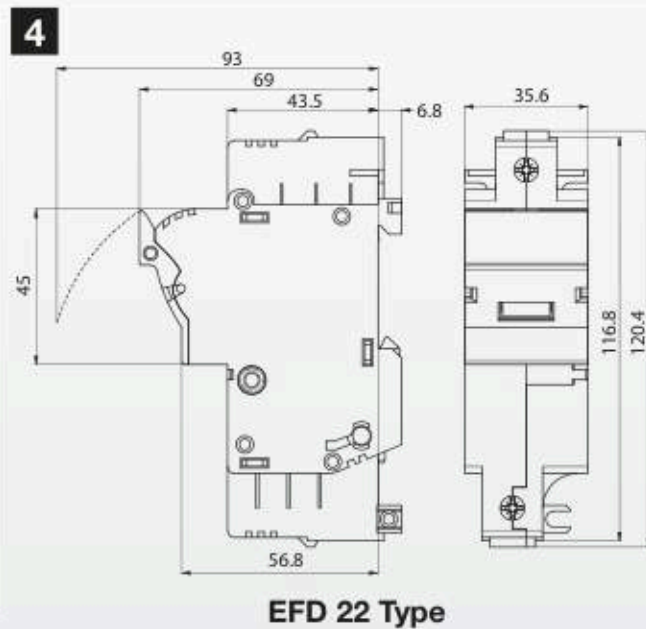
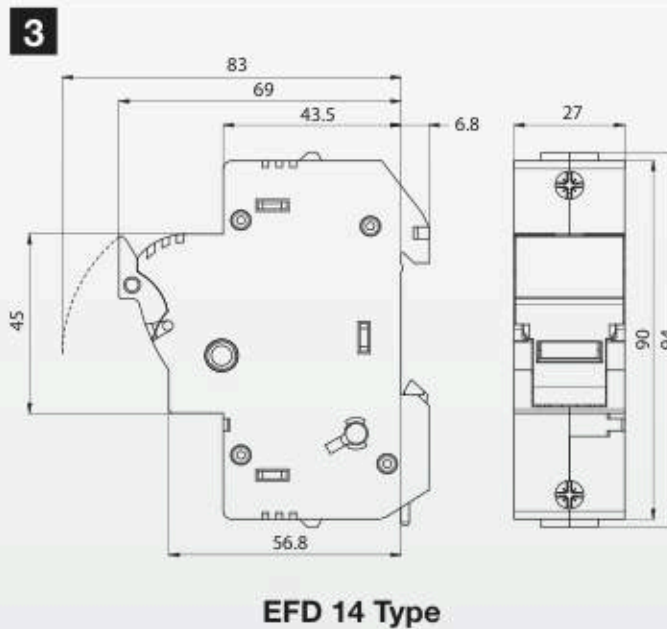
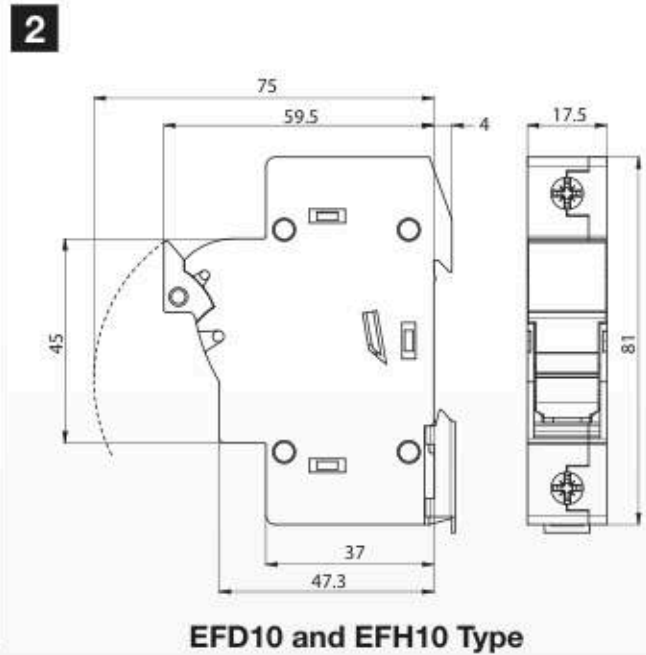
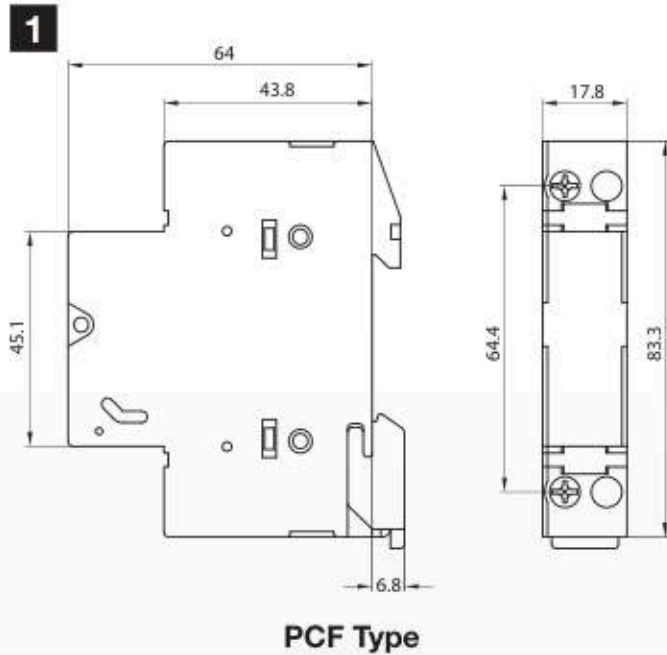

NOTE: All dimensions are shown in millimeters. To convert to inches multiply by 0.03937

Accessories for The Modular Type PCF, EFD and EFH

Modular fuse holders have a unique user configurable feature. By using the modular snap kit (parts sold individually) a customer can configure any pole configuration by inserting the connecting element (3 per pole) into the slot in the side of the fuse holder and then pushing them together and inserting the connecting shaft into the handle.

NOTE: 1 kit suffices for the assembly of 50 sets.



2 Pole Connection Kits

Model No.	Usable with
002540948	EFD 8, EFD 10, EFH 10, PCF 8, PCF 10, EFD CC, PCF CC
002560948	EFD 14, EFH 14
002570948	EFD 22, EFD J30

3 Pole Connection Kits

Model No.	Usable with
002540949	EFD 8, EFD 10, PCF 8, PCF 10, EFD CC, PCF CC
002560949	EFD 14
002570949	EFD 22, EFD J30

Auxiliary Switches

Model No.	Usable with	Type
002559001	PCF 10	1NO/1NC
002569001	EFD 14	1NO/1NC
002579001	EFD 22	1NO/1NC

For Auxiliary switches to operate, a fuse with striker pin must be used.



DISCONNECT & TEST

SCREW TERMINAL BLOCKS

DISCONNECT AND TEST TERMINAL BLOCKS

HIGHLIGHTS

FEATURES

- Slider Style Disconnect Terminals
- **CDS6U** - Standard Slider Disconnect
- **CDS6U/TS** - Slider Disconnect with integrated testing points
- **CDS6U/FT** - Same profile Feed-Through
- Separate Testing points allow insertion of standard test probes
- Disconnect is achieved by operating sliding link with screw driver
- **SLS2, SLS4** slide shorting link system
- **QJ8/2** - Shorting Plug

APPLICATIONS

- (see following page)
- Disconnect & Test Applications
 - Measuring / Control Circuits
 - Utility Instruments and Transformer Applications
 - Meter Replacement
 - External Current Measurement
 - Switch Boards

CDS6U



Slider Disconnect Terminal

CDS6U/TS



Slider Disconnect Terminal Including Test Sockets

CDS6U/FT



Feed Through Terminal with CDS6U profile

Dimensions & Weight

	CDS6U	CDS6U/TS	CDS6U/FT
Width	8 mm	8 mm	6 mm
Length	82 mm	82 mm	82 mm
Height w DIN Rail	35 x 7.5 mm 35 x 15 mm	51.0 mm 59.2 mm	51.0 mm 59.2 mm
Weight per piece	33.8 g	33.8 g	21.2 g

Technical Data/Ratings

Approvals						
Wire Size (solid / stranded)	22-8 AWG	0.2-6 mm ²	22-8 AWG	0.2-6 mm ²	22-8 AWG	0.2-6 mm ²
Voltage Rating	600 V	800 V	600 V	800 V	600 V	800 V
Current Rating	45 A	41 A	45 A	41 A	45 A	41 A
Torque	14 lb-in	0.8 Nm	14 lb-in	0.8 Nm	14 lb-in	0.8 Nm
Insulation Material	Polyamide 66		Polyamide 66		Polyamide 66	

Installation Instructions

Wire Stripping Length	10 mm	10 mm	10 mm
Screwdriver	Flat Head 0.8 x 4 mm	Flat Head 0.8 x 4 mm	Flat Head 0.8 x 4 mm

Terminal Blocks

	Cat. No.	Std. Pk.	Cat. No.	Std. Pk.	Cat. No.	Std. Pk.
Grey (standard)	CDS6U	50	CDS6U/TS	50	CDS6U/FT	50
Red R	CDS6U/R	50	CDS6U/TS/R	50	CDS6U/FT/R	50
Blue BU	CDS6U/BU	50	CDS6U/TS/BU	50	CDS6U/FT/BU	50
Black BL	CDS6U/BL	50	CDS6U/TS/BL	50	CDS6U/FT/BL	50
Orange O	CDS6U/O	50	CDS6U/TS/O	50	CDS6U/FT/O	50
Green G	CDS6U/G	50	CDS6U/TS/G	50	CDS6U/FT/G	50
Yellow Y	CDS6U/Y	50	CDS6U/TS/Y	50	CDS6U/FT/Y	50
White W	CDS6U/W	50	CDS6U/TS/W	50	CDS6U/FT/W	50

Accessories

	Cat. No.	Std. Pk.	Cat. No.	Std. Pk.	Cat. No.	Std. Pk.	
End Plate	EPCDS6U	50	EPCDS6U	50	EPCDS6U	50	
DIN Rail	2511120 CA701-15/S 2511160	20 20 10	2511120 CA701-15/S 2511160	20 20 10	2511120 CA701-15/S 2511160	20 20 10	
End Stop	CA702 CA802 CA202	50 50 25	CA702 CA802 CA202	50 50 25	CA702 CA802 CA202	50 50 25	
Internal Jumper	2 pole 3 pole 4 pole 10 pole	CA723/2 CA723/3 CA723/4 CA723/10	100 50 50 10	CA723/2 CA723/3 CA723/4 CA723/10	100 50 50 10	CA723/2 CA723/3 CA723/4 CA723/10	100 50 50 10
Slide Shorting Link	2 pole 3 pole 4 pole	SLS2 SLS3 SLS4	50 25 25	SLS2 SLS3 SLS4	50 25 25	- - -	- - -
Insulated Test Socket	grey red yellow blue black	TPSL TPSLR TPSLY TPSLBU TPSLBK	100 100 100 100 100	- - - - -	- - - - -	- - - - -	
Lock Out Cap	LCCDS	50	LCCDS	50	-	-	
Shorting Plug	QJ8/2	25	QJ8/2	25	-	-	
Marking Tag	MT6	1 Pk. (100 tags)	MT6	1 Pk. (100 tags)	MT8	1 Pk. (100 tags)	

Example for CDS6U Test & Disconnect Terminal Block

Single Phase Current Transformer Test Circuit

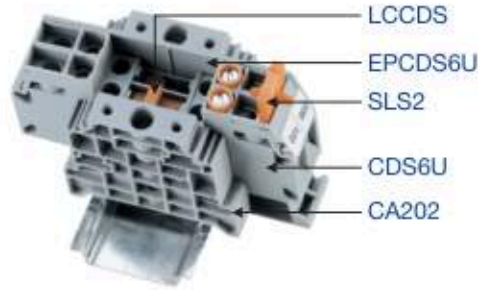

Operating status

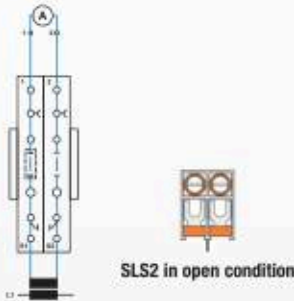

Comparison measurement for L1

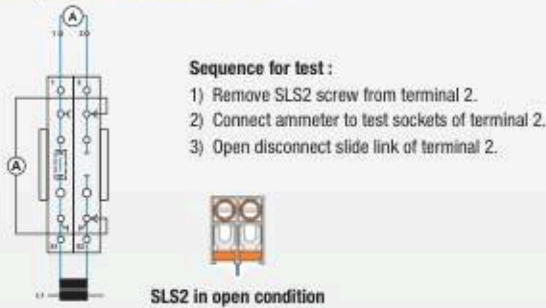

Meter test for L1 through external power supply

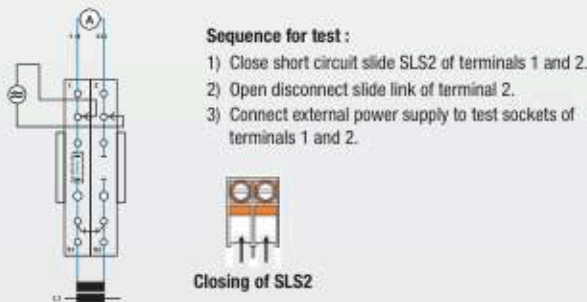

Meter replacement

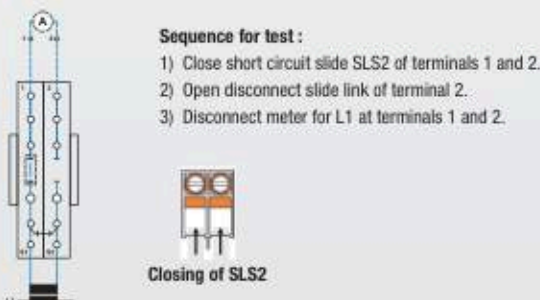

3 Phase current Transformer Test Set

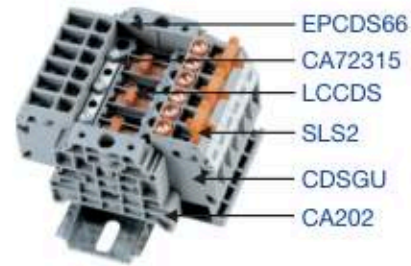

Operating status

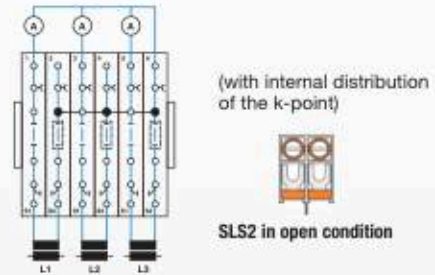

Comparison measurement for L1

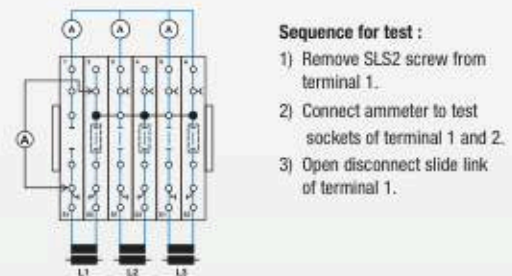

Meter test for L1 through external power supply

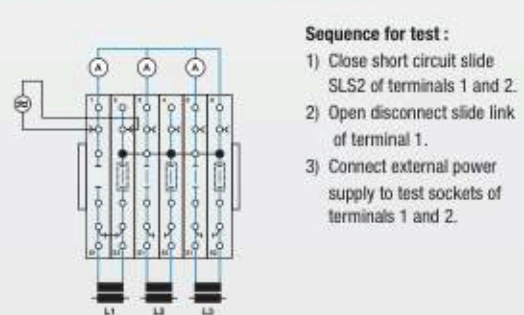

Meter Replacement for L1

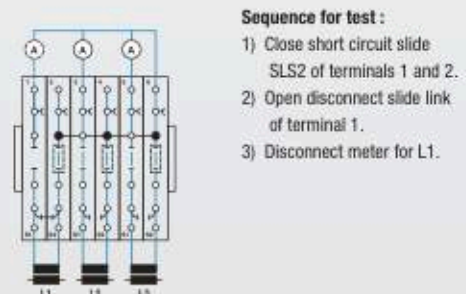

DISCONNECT & TEST

SCREW TERMINAL BLOCKS

BLADE/KNIFE STYLE DISCONNECT TERMINAL BLOCKS

HIGHLIGHTS

FEATURES

- Knife / Blade Style Disconnect Terminals
- **CKT4U** - Standard Knife Disconnect
- **CKT4U/4** - 4 Connection Knife Disconnect
- Specially designed socket headed screws act as fast monitoring points

APPLICATIONS

- Disconnect & Test Applications

CKT4U



CKT4U/4



Dimensions & Weight

	Knife Style Disconnect 2 Connections	Knife Style Disconnect 4 Connections
Width	6 mm	6 mm
Length	46.3 mm	65.0 mm
Height w DIN Rail	48.3 mm 35 x 7.5 mm 56.0 mm 35 x 15 mm	54.3 mm 62.0 mm
Weight per piece	10.5 g	16.6 g

Technical Data/Ratings

Approvals					
Wire Size (solid / stranded)	22-10 AWG	22-10 AWG	0.2-4 mm ²	22-10 AWG	0.2-4 mm ²
Voltage Rating	600 V	600 V	800 V	600 V	800 V
Current Rating	35 A	16 A	28 A	20 A	17.5 A
Torque	7 lb-in	7 lb-in	0.5 Nm	7 lb-in	0.5 Nm
Insulation Material	Polyamide 66			Polyamide 66	

Installation Instructions

Wire Stripping Length	8 mm	8 mm
Screwdriver	Flat Head 0.6 x 3.5 mm	Flat Head 0.6 x 3.5 mm

Terminal Blocks

	Cat. No.	Std. Pk.	Cat. No.	Std. Pk.
Grey (standard)	CKT4U	50	CKT4U/4	50
Red R	CKT4U/R	50	CKT4U/4/R	50
Blue BU	CKT4U/BU	50	CKT4U/4/BU	50
Black BL	CKT4U/BL	50	CKT4U/4/BL	50
Orange O	CKT4U/O	50	CKT4U/4/O	50
Green G	CKT4U/G	50	CKT4U/4/G	50
Yellow Y	CKT4U/Y	50	CKT4U/4/Y	50
White W	CKT4U/W	50	CKT4U/4/W	50

Accessories

	Cat. No.	Std. Pk.	Cat. No.	Std. Pk.
End Plate	EPCXT4U	50	EPCXT4U/4	50
DIN Rail	2511120 CA701-15/S 2511160	20 20 10	2511120 CA701-15/S 2511160	20 20 10
End Stop	CA702 CA802 CA202	50 50 25	CA702 CA802 CA202	50 50 25
External Jumper	2 pole CA714/2 3 pole CA714/3 4 pole CA714/4 10 pole CA714/10	100 100 100 20	CA714/2* CA714/3* CA714/4* CA714/10*	100 100 100 20
Marking Tag	MT6	1 Pk. (100 tags)	MT6	1 Pk. (100 tags)

* Insulated External shorting links can be used only in the upper level clamping unit of the Terminal Block.

CKT4SP



CF4SPFT



CF4SP

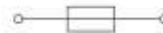

HIGHLIGHTS

FEATURES

- Knife Style Disconnect Terminal
- **CF4SPFT** same profile Feed Through Terminal
- **CF4SP** same profile as Fuse Terminal, 5 x 20 mm Fuse Types

APPLICATIONS

- Control Systems with Fuse Protection
- Fused Control Circuits with alternating configurations (CF4SP, CF4SPFT, CGT4SP)
- Switch Boards

Dimensions & Weight

	Knife Style Disconnect Same profile as CF4SP Fuse Block	Feed-Through Terminal Same profile as CF4SP Fuse Block	Fuse Block 5x20 mm Fuse Type
Width	6 mm	6 mm	8 mm
Length	58.5 mm	58.5 mm	57.0 mm
Height w/ DIN Rail	35 x 7.5 mm 35 x 15 mm	46.0 mm 53.5 mm	50.3 mm 57.6 mm
Weight per piece	27.2 g	g	16.9 g

Technical Data/Ratings

Approvals						
Wire Size (solid / stranded)	24-10 AWG	0.2-4 mm ²	24-10 AWG	0.2-4 mm ²	24-10 AWG	0.2-4 mm ²
Voltage Rating	600 V	1000 V	600 V	1000 V	600 V	1000 V AC/DC
Current Rating	30 A	28 A	30 A	32 A	10 A	10 A
Torque	4.5 lb-in	0.5 Nm	4.5 lb-in	0.5 Nm	4.5 lb-in	0.5 Nm
Insulation Material	Polyamide 66		Polyamide 66		Polyamide 66	

Installation Instructions

Wire Stripping Length	8 mm	8 mm	8 mm
Screwdriver	Flat Head 0.6 x 3.5 mm	Flat Head 0.6 x 3.5 mm	Flat Head 0.6 x 3.5 mm

Terminal Blocks

	Cat. No.	Std. Pk.	Cat. No.	Std. Pk.	Cat. No.	Std. Pk.
Grey (standard)	CKT4SP	50	CF4SPFT	50	CF4SP	50
Red R	CKT4SP/R	50	CF4SPFT/R	50	CF4SP/BU	50
Blue BU	CKT4SP/BU	50	CF4SPFT/BU	50	CF4SP/BL	50
Black BL	CKT4SP/BL	50	CF4SPFT/BL	50		
Orange O	CKT4SP/O	50	CF4SPFT/O	50		
Green G	CKT4SP/G	50	CF4SPFT/G	50		
Yellow Y	CKT4SP/Y	50	CF4SPFT/Y	50		
White W	CKT4SP/W	50	CF4SPFT/W	50		

Accessories

	Cat. No.	Std. Pk.	Cat. No.	Std. Pk.	Cat. No.	Std. Pk.
DIN Rail 	2511120	20	2511120	20	2511120	20
	CA701-15/S	20	CA701-15/S	20	CA701-15/S	20
	2511160	10	2511160	10	2511160	10
End Stop 	CA702	50	CA702	50	-	-
	CA802	50	CA802	50	-	-
	CA202	25	CA202	25	-	-
Internal Jumper 	2 pole CA722/2	100	2 pole CA722/2	100	2 pole CA722/2	100
	3 pole CA722/3	100	3 pole CA722/3	100	3 pole CA722/3	100
	4 pole CA722/4	100	4 pole CA722/4	100	4 pole CA722/4	100
	10 pole CA722/10	10	10 pole CA722/10	10	10 pole CA722/10	10
	100 pole CA722/100	10	100 pole CA722/100	10	100 pole CA722/100	10
	Insulated Internal Jumper 	2 pole CA742/2	100	2 pole CA742/2	100	2 pole CA742/2
3 pole CA742/3	100	3 pole CA742/3	100	3 pole CA742/3	100	
4 pole CA742/4	100	4 pole CA742/4	100	4 pole CA742/4	100	
10 pole CA742/10	10	10 pole CA742/10	10	10 pole CA742/10	10	
100 pole CA742/100	10	100 pole CA742/100	10	100 pole CA742/100	10	
External Jumper 	2 pole CA714/2	100	2 pole CA714/2	100	2 pole CA714/2	100
	3 pole CA714/3	100	3 pole CA714/3	100	3 pole CA714/3	100
	4 pole CA714/4	100	4 pole CA714/4	100	4 pole CA714/4	100
	10 pole CA714/10	20	10 pole CA714/10	20	10 pole CA714/10	20
	Marking Tag 	MT6	1 Pk. (100 tags)	MT6	1 Pk. (100 tags)	MT6

DISCONNECT & TEST

SCREW TERMINAL BLOCKS

SLIDER STYLE DISCONNECT TERMINAL BLOCKS

HIGHLIGHTS

FEATURES

- Slider Style Disconnect Terminals
- **CDTTU** - Standard Slider Disconnect
- **CDTTU-SH** - Double Disconnect Terminal
- **CDTTUFT** - Same profile Feed-Through
- Specially designed socket headed screws act as fast monitoring points
- Disconnect is achieved by operating sliding link with screw driver

APPLICATIONS

- Disconnect & Test Applications

CDTTU



CDTTU-SH

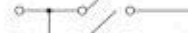

CDTTUFT



Dimensions & Weight

Width	
Length	
Height w DIN Rail	35 x 7.5 mm 35 x 15 mm
Weight per piece	

Slider Disconnect Terminal	8 mm
	63 mm
	58.7 mm 65.7 mm
	28.5 g

Slider Double Disconnect Terminal	16 mm
	63 mm
	58.7 mm 65.7 mm
	59.2 g

Feed Through Terminal Slider Disconnect Profile	8 mm
	63 mm
	58.7 mm 65.7 mm
	27.1 g

Technical Data/Ratings

Approvals	CE, RoHS, LowVols Register
Wire Size (solid / stranded)	16-8 AWG, 1.5-10 mm ²
Voltage Rating	600 V, 800 V
Current Rating	41 A, 57 A
Torque	14 lb-in, 1.2 Nm
Insulation Material	Polyamide 66

Approvals	UL E220514, SP US, IEC 60947-7-1
Wire Size (solid / stranded)	16-8 AWG, 1.5-10 mm ²
Voltage Rating	600 V, 800 V
Current Rating	41 A, 57 A
Torque	14 lb-in, 1.2 Nm
Insulation Material	Polyamide 66

Approvals	UL E220514, SP US, IEC 60947-7-1
Wire Size (solid / stranded)	16-8 AWG, 1.5-10 mm ²
Voltage Rating	300 V, 300 V, 160 V
Current Rating	25 A, 25 A, 10 A
Torque	14 lb-in, 14 lb-in, 1.2 Nm
Insulation Material	Polyamide 66

Approvals	UL E220514, SP US, IEC 60947-7-1
Wire Size (solid / stranded)	16-8 AWG, 1.5-10 mm ²
Voltage Rating	600 V, 800 V
Current Rating	41 A, 57 A
Torque	14 lb-in, 1.2 Nm
Insulation Material	Polyamide 66

Installation Instructions

Wire Stripping Length	12 mm
Screwdriver	Flat Head 1.0 x 5.5 mm

Wire Stripping Length	12 mm
Screwdriver	Flat Head 1.0 x 5.5 mm

Wire Stripping Length	12 mm
Screwdriver	Flat Head 1.0 x 5.5 mm

Wire Stripping Length	12 mm
Screwdriver	Flat Head 1.0 x 5.5 mm

Terminal Blocks

Grey (standard)	
Red	R
Blue	BU
Black	BL
Orange	O
Green	G
Yellow	Y
White	W

Cat. No.	Std. Pk.
CDTTU	50
CDTTU/R	50
CDTTU/BU	50
CDTTU/BL	50
CDTTU/O	50
CDTTU/G	50
CDTTU/Y	50
CDTTU/W	50

Cat. No.	Std. Pk.
CDTTU-SH	20
CDTTU-SH/R	20
CDTTU-SH/BU	20
CDTTU-SH/BL	20
CDTTU-SH/O	20
CDTTU-SH/G	20
CDTTU-SH/Y	20
CDTTU-SH/W	20

Cat. No.	Std. Pk.
CDTTUFT	50
CDTTUFT/R	50
CDTTUFT/BU	50
CDTTUFT/BL	50
CDTTUFT/O	50
CDTTUFT/G	50
CDTTUFT/Y	50
CDTTUFT/W	50

Accessories

End Plate	EPCDTTU	50	
DIN Rail	2511120	20	
	CA701-15/S	20	
	2511160	10	
End Stop	CA702	50	
	CA802	50	
	CA202	25	
Shorting Plug	2 pole	QJ8/2	25
External Jumper	2 pole	CA710/2	100
	3 pole	CA710/3	50
	4 pole	CA710/4	50
	10 pole	CA710/10	20
	Shorting Plug	QJ8/2	25
Marking Tag	MT8	1 Pk. (100 tags)	

End Plate	EPCDTTU	50	
DIN Rail	2511120	20	
	CA701-15/S	20	
	2511160	10	
End Stop	CA702	50	
	CA802	50	
	CA202	25	
Shorting Plug	2 pole	QJ8/2	25
External Jumper	2 pole	CA710/2	100
	3 pole	CA710/3	50
	4 pole	CA710/4	50
	10 pole	CA710/10	20
	Shorting Plug	QJ8/2	25
Marking Tag	MT8	1 Pk. (100 tags)	

End Plate	EPCDTTU	50	
DIN Rail	2511120	20	
	CA701-15/S	20	
	2511160	10	
End Stop	CA702	50	
	CA802	50	
	CA202	25	
Shorting Plug	2 pole	QJ8/2	25
External Jumper	2 pole	CA710/2	100
	3 pole	CA710/3	50
	4 pole	CA710/4	50
	10 pole	CA710/10	20
	Shorting Plug	QJ8/2	25
Marking Tag	MT8	1 Pk. (100 tags)	

End Plate	EPCDTTU	50	
DIN Rail	2511120	20	
	CA701-15/S	20	
	2511160	10	
End Stop	CA702	50	
	CA802	50	
	CA202	25	
Shorting Plug	2 pole	QJ8/2	25
External Jumper	2 pole	CA710/2	100
	3 pole	CA710/3	50
	4 pole	CA710/4	50
	10 pole	CA710/10	20
	Shorting Plug	QJ8/2	25
Marking Tag	MT8	1 Pk. (100 tags)	

LEVER STYLE DISCONNECT TERMINAL BLOCKS

CSDL4U



DDDL4U



Dimensions & Weight

	Lever Style Disconnect	Lever Style Disconnect Bottom Level Feed Through
Width	8 mm	8 mm
Length	58 mm	88 mm
Height w/ DIN Rail	35 x 7.5 mm 35 x 15 mm	67.4 mm 74.3 mm
Weight per piece	15.0 g	27.0 g

Technical Data/Ratings

Approvals						
Wire Size (solid / stranded)	22-10 AWG	0.2-4 mm ²	22-10 AWG	22-10 AWG	0.2-4 mm ²	0.2-4 mm ²
Voltage Rating	600 V	1000 V	600 V	600 V	800 V	800 V
Current Rating	Top Bottom	14 A -	10 A -	6.3 A 35 A	14 A 32 A	10 A 32 A
Torque	7 lb-in	0.5 Nm	7 lb-in	7 lb-in	0.5 Nm	0.5 Nm
Insulation Material	Polyamide 66		Polyamide 66			

Installation Instructions

Wire Stripping Length	9.5 mm	9.5 mm
Screwdriver	Flat Head 0.6 x 3.5 mm	Flat Head 0.6 x 3.5 mm

Terminal Blocks

	Cat. No.	Std. Pk.	Cat. No.	Std. Pk.
Grey (standard)	CSDL4U	100	DDDL4U	20
Red R	CSDL4U/R	100	DDDL4U/R	20
Blue BU	CSDL4U/BU	100	DDDL4U/BU	20
Black BL	CSDL4U/BL	100	DDDL4U/BL	20
Orange O	CSDL4U/O	100	DDDL4U/O	20
Green G	CSDL4U/G	100	DDDL4U/G	20
Yellow Y	CSDL4U/Y	100	DDDL4U/Y	20
White W	CSDL4U/W	100	DDDL4U/W	20

Accessories

	Cat. No.	Std. Pk.	Cat. No.	Std. Pk.	
End Plate	EPCSFL4U	50	EPDDL4U	50	
Isolation Partition	PPCSFL4U	50	-	-	
DIN Rail	2511120 CA701-15/S 2511160	20 20 10	2511120 CA701-15/S 2511160	20 20 10	
End Stop	CA702 CA802 CA202	50 50 50	CA702 CA802 CA202	50 50 50	
Internal Jumper	2 pole 3 pole 4 pole 10 pole	- - - -	CA729/2 CA729/3 CA729/4 CA729/10	100 50 50 10	
Insulated Jumper	2 pole 3 pole 4 pole 10 pole	- - - -	CA749/2 CA749/3 CA749/4 CA749/10	100 50 50 10	
External Jumper	2 pole 3 pole 4 pole 10 pole	CA711/2 CA711/3 CA711/4 CA711/10	100 50 50 20	CA711/2 CA711/3 CA711/4 CA711/10	100 50 50 2
Marking Tag	MT8 MT2	1 Pk. (100 tags) 1 Pk. (100 tags)	MT8 MT2	1 Pk. (100 tags) 1 Pk. (100 tags)	

HIGHLIGHTS

FEATURES

- Lever Style Disconnect Terminals
- **CSDL4U** - Standard Lever Disconnect
- **DDDL4U** - Lever Disconnect with Lower Level Feed-Through
- Same profile as **CAFL4U**

APPLICATIONS

- Disconnect Applications

CDB4/X(1)



HIGHLIGHTS

FEATURES

- Distribution blocks with various output configurations
- Stud/Bolt to secure incoming wire
- Internally connected terminals
- Side/center feed versions
- up to 150A
- Protective shield for incoming wire

APPLICATIONS

- Simplified distribution systems
- Phase distribution application

INSTALLATION NOTES

- Sum of outgoing wires not to exceed incoming current
- Higher output currents should be connected close to the input

Dimensions & Weight

Width	6 Outputs	52.0 mm
	8 Outputs	58.0 mm
	10 Outputs	64.0 mm
	12 Outputs	70.0 mm
	14 Outputs	76.0 mm
	22 Outputs	100.0 mm
Length	24 Outputs	106.0 mm
		43 mm
Height w DIN Rail	35 x 7.5 mm	46.2 mm
	35 x 15 mm	53.7 mm

50A Distribution Terminal Block Side Feed	
	52.0 mm
	58.0 mm
	64.0 mm
	70.0 mm
	76.0 mm
	100.0 mm
	106.0 mm
	43 mm
	46.2 mm
	53.7 mm

General Specifications

Approvals	
Voltage Rating	600 V / 800 V AC/DC
Insulation Material	Polyamide 66

INPUT

Technical Data/Ratings

Wire Size (solid / stranded)	10-8 AWG	6-16 mm ²
Current Rating	50 A	64 A
Torque	26 lb-in	2.0 Nm

Installation Instructions

Wire Stripping Length	8 mm
Screwdriver	Hex Nut Driver M8

OUTPUT

Technical Data/Ratings

Wire Size (solid / stranded)	22-10 AWG	0.2-4 mm ²
Current Rating	35 A	64 A*
Torque	7 lb-in	0.5 Nm

Installation Instructions

Wire Stripping Length	8 mm
Screwdriver	Flat Head 0.6 x 3.5 mm

Terminal Blocks

	Cat. No.	Std. Pk.
Grey (standard)		
6 Outputs	CDB4/2(1)	10
8 Outputs	CDB4/3(1)	10
10 Outputs	CDB4/4(1)	10
12 Outputs	CDB4/5(1)	5
14 Outputs	CDB4/6(1)	5
22 Outputs	CDB4/10(1)	5
24 Outputs	CDB4/11(1)	5

Accessories

	Cat. No.	Std. Pk.
DIN Rail	2511120	20
	CA701-15/S	20
	2511160	10
End Stop	CA702	50
	CA802	50
Marking Tag	MT6	1 Pk. (100 tags)

* Total output current of system

Phase Distribution Application with CDB Terminals

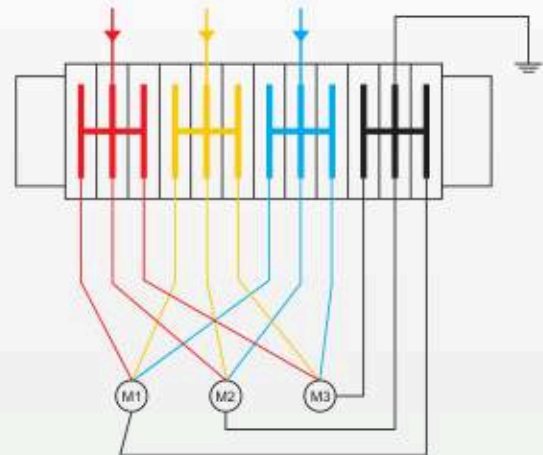

CENTER FEED DISTRIBUTION TERMINAL BLOCKS

DISTRIBUTION SCREW TERMINAL BLOCKS



Dimensions & Weight

	50A Distribution Terminal Block Center Feed	100A Distribution Terminal Block Center Feed	130A Distribution Terminal Block Center Feed	150A Distribution Terminal Block Center Feed
Width	4 Outputs	44.0 mm	48.0 mm	-
	8 Outputs	56.0 mm	64.0 mm	-
	12 Outputs	68.0 mm	80.0 mm	72.0 mm
	16 Outputs	80.0 mm	96.0 mm	92.0 mm
	20 Outputs	96.0 mm	-	112.0 mm
	24 Outputs	108.0 mm	-	-
Length	43 mm	48 mm	48 mm	49 mm
Height w DIN Rail	35 x 7.5 mm	46.2 mm	47.8 mm	57.2 mm
	35 x 15 mm	53.7 mm	55.5 mm	64.7 mm

General Specifications

Approvals								
Voltage Rating	600 V	800 V AC/DC	600 V	800 V AC/DC	600 V	800 V AC/DC	600 V	800 V AC/DC
Insulation Material	Polyamide 66		Polyamide 66		Polyamide 66		Polyamide 66	

INPUT

Technical Data/Ratings

Wire Size (solid / stranded)	10-8 AWG	6-16 mm ²	10-2 AWG	6-25 mm ²	8-1/0 AWG	10-35 mm ²	6-2/0 AWG	10-50 mm ²
Current Rating	50 A	64 A	100 A	82 A	130 A	114 A	150 A	150 A
Torque	26 lb-in	2.0 Nm	35 lb-in	3.0 Nm	53 lb-in	6.0 Nm	53 lb-in	6.0 Nm

Installation Instructions

Wire Stripping Length	8 mm	9 mm	11 mm	14 mm
Screwdriver	Hex Nut Driver M8	Hex Nut Driver M10	Hex Nut Driver M13	Hex Nut Driver M15

OUTPUT

Technical Data/Ratings

Wire Size (solid / stranded)	22-10 AWG	0.2-4 mm ²	22-8 AWG	1.5-6 mm ²	22-6 AWG	1.5-10 mm ²	12-2 AWG	6-25 mm ²
Current Rating (per output)	35 A	32 A	50 A	41 A	65 A	57 A	75 A	75 A
Torque	7 lb-in	0.5 Nm	14 lb-in	0.8 Nm	14 lb-in	1.2 Nm	22 lb-in	2.0 Nm

Installation Instructions

Wire Stripping Length	8 mm	9 mm	11 mm	14 mm
Screwdriver	Flat Head 0.6 x 3.5 mm	Flat Head 0.8 x 4 mm	Flat Head 0.8 x 4 mm	Flat Head 1.0 x 5.5 mm

Terminal Blocks

	Cat. No.	Std. Pk.	Cat. No.	Std. Pk.	Cat. No.	Std. Pk.	Cat. No.	Std. Pk.
Grey (standard)	4 Outputs	CDB4/1	10	CDB6/1	10	-	CDB25/1	10
	8 Outputs	CDB4/2	10	CDB6/2	10	CDB10/2	CDB25/2	10
	12 Outputs	CDB4/3	10	CDB6/3	10	CDB10/3	CDB25/3	10
	16 Outputs	CDB4/4	10	CDB6/4	5	CDB10/4	CDB25/4	5
	20 Outputs	CDB4/5	5	-	-	-	-	-
	24 Outputs	CDB4/6	5	-	-	-	-	-

Accessories

	Cat. No.	Std. Pk.	Cat. No.	Std. Pk.	Cat. No.	Std. Pk.	Cat. No.	Std. Pk.
DIN Rail 	2511120	20	2511120	20	2511120	20	2511120	20
	CA701-15/S	20	CA701-15/S	20	CA701-15/S	20	CA701-15/S	20
	2511160	10	2511160	10	2511160	10	2511160	10
End Stop 	CA702	50	CA702	50	CA702	50	CA702	50
	CA802	50	CA802	50	CA802	50	CA802	50
Marking Tag 	MT6	1 Pk. (100 tags)	MT8	1 Pk. (100 tags)	MT10	1 Pk. (100 tags)	MT12	1 Pk. (100 tags)

CMDB4/X



CMDB6/X



CMDB10/X



CMDB25/X



Dimensions

	35 A Distribution Terminal Block	50 A Distribution Terminal Block	65 A Distribution Terminal Block	85 A Distribution Terminal Block	
Width	2 pole 3 pole 4 pole 10 pole	13.5 mm 19.5 mm 25.5 mm 61.5 mm	17.5 mm 25.5 mm 33.5 mm 81.5 mm	21.5 mm 31.5 mm 41.5 mm 101.5 mm	26.0 mm 38.0 mm 50.0 mm 62.0 mm
Length	43 mm	48 mm	48 mm	49 mm	
Height w DIN Rail	35 x 7.5 mm 35 x 15 mm	46.2 mm 53.7 mm	47.8 mm 55.5 mm	47.8 mm 55.5 mm	57.2 mm 64.7 mm

Technical Data/Ratings

Approvals								
Wire Size (solid / stranded)	22-10 AWG	0.2-4 mm ²	22-8 AWG	1.5-6 mm ²	22-6 AWG	1.5-10 mm ²	12-4 AWG	6.0-25 mm ²
Voltage Rating	600 V	1000V AC/DC	600 V	1000V AC/DC	600 V	1000V AC/DC	600 V	800V AC/DC
Current Rating	35 A	32 A	50 A	41 A	65 A	57 A	85 A	101 A
Torque	7 lb-in	0.5 Nm	14 lb-in	0.8 Nm	14 lb-in	1.2 Nm	22 lb-in	2.0 Nm
Insulation Material	Polyamide 66		Polyamide 66		Polyamide 66		Polyamide 66	

Installation Instructions

Wire Stripping Length	8 mm	9 mm	11 mm	14 mm
Screwdriver	Flat Head 0.6 x 3.5 mm	Flat Head 0.8 x 4 mm	Flat Head 0.8 x 4 mm	Flat Head 1.0 x 5.5 mm

Terminal Blocks

4 Outputs

	Cat. No.	Std. Pk.	Cat. No.	Std. Pk.	Cat. No.	Std. Pk.	Cat. No.	Std. Pk.
Grey (standard)	CMDB4/2	10	CMDB6/2	10	CMDB10/2	10	CMDB25/2	10
Red R	CMDB4/2/R	10	CMDB6/2/R	10	CMDB10/2/R	10	CMDB25/2/R	10
Blue BU	CMDB4/2/BU	10	CMDB6/2/BU	10	CMDB10/2/BU	10	CMDB25/2/BU	10
Black BL	CMDB4/2/BL	10	CMDB6/2/BL	10	CMDB10/2/BL	10	CMDB25/2/BL	10

6 Outputs

	Cat. No.	Std. Pk.	Cat. No.	Std. Pk.	Cat. No.	Std. Pk.	Cat. No.	Std. Pk.
Grey (standard)	CMDB4/3	10	CMDB6/3	10	CMDB10/3	10	CMDB25/3	10
Red R	CMDB4/3/R	10	CMDB6/3/R	10	CMDB10/3/R	10	CMDB25/3/R	10
Blue BU	CMDB4/3/BU	10	CMDB6/3/BU	10	CMDB10/3/BU	10	CMDB25/3/BU	10
Black BL	CMDB4/3/BL	10	CMDB6/3/BL	10	CMDB10/3/BL	10	CMDB25/3/BL	10

8 Outputs

	Cat. No.	Std. Pk.	Cat. No.	Std. Pk.	Cat. No.	Std. Pk.	Cat. No.	Std. Pk.
Grey (standard)	CMDB4/4	10	CMDB6/4	10	CMDB10/4	10	CMDB25/4	10
Red R	CMDB4/4/R	10	CMDB6/4/R	10	CMDB10/4/R	10	CMDB25/4/R	10
Blue BU	CMDB4/4/BU	10	CMDB6/4/BU	10	CMDB10/4/BU	10	CMDB25/4/BU	10
Black BL	CMDB4/4/BL	10	CMDB6/4/BL	10	CMDB10/4/BL	10	CMDB25/4/BL	10

20 Outputs

	Cat. No.	Std. Pk.	Cat. No.	Std. Pk.	Cat. No.	Std. Pk.	Cat. No.	Std. Pk.
Grey (standard)	CMDB4/10	10	CMDB6/10	10	CMDB10/10	5	CMDB25/10	10
Red R	CMDB4/10/R	10	CMDB6/10/R	10	CMDB10/10/R	5	CMDB25/10/R	10
Blue BU	CMDB4/10/BU	10	CMDB6/10/BU	10	CMDB10/10/BU	5	CMDB25/10/BU	10
Black BL	CMDB4/10/BL	10	CMDB6/10/BL	10	CMDB10/10/BL	5	CMDB25/10/BL	10

Accessories

	Cat. No.	Std. Pk.	Cat. No.	Std. Pk.	Cat. No.	Std. Pk.	Cat. No.	Std. Pk.
DIN Rail	2511120	20	2511120	20	2511120	20	2511120	20
	CA701-15/S	20	CA701-15/S	20	CA701-15/S	20	CA701-15/S	20
	2511160	10	2511160	10	2511160	10	2511160	10
End Stop	CA702	50	CA702	50	CA702	50	CA702	50
	CA802	50	CA802	50	CA802	50	CA802	50
Marking Tag	MT6	1 Pk. (100 tags)	MT8	1 Pk. (100 tags)	MT10	1 Pk. (100 tags)	MT12	1 Pk. (100 tags)

CXDB35/10

CXDB35/10A



1 Flat Head Screw Input
4 Spring Clamp Outputs

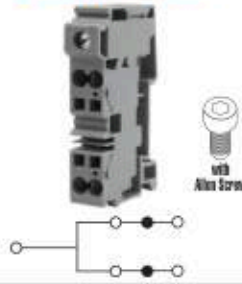

1 Hex Screw Input
4 Spring Clamp Outputs

Dimensions & Weight

Width	16 mm	16 mm
Length	81.6 mm	81.6 mm
Height w/ DIN Rail	35 x 7.5 mm 35 x 15 mm	46.8 mm 54.3 mm
Weight per piece	53.2 g	53.2 g

General Specifications

Approvals		
Voltage Rating	600 V 1000V AC/DC	600 V 1000V AC/DC
Insulation Material	Polyamide 66	

INPUT

Technical Data/Ratings

Wire Size (solid / stranded)	14-2 AWG	1.5-35 mm ²	14-2 AWG	1.5-35 mm ²
Current Rating	115 A	125 A	115 A	125 A
Torque	25 lb-in	2.5 Nm	25 lb-in	2.5 Nm

Installation Instructions

Wire Stripping Length	17 mm	17 mm
Screwdriver	Flat Head 1.0 x 5.5 mm	Hex Screw M5

OUTPUT

Technical Data/Ratings

Wire Size (solid / stranded)	24-8 AWG	0.2-10 mm ²	24-8 AWG	0.2-10 mm ²
Current Rating	41 A	41 A	41 A	41 A

Installation Instructions

Wire Stripping Length	15 mm	15 mm
Screwdriver	Flat Head 0.8 x 4 mm	Flat Head 0.8 x 4 mm

Terminal Blocks

	Cat. No.	Std. Pk.	Cat. No.	Std. Pk.
Grey	CXDB35/10	20	CXDB35/10A	20

Accessories

	Cat. No.	Std. Pk.	Cat. No.	Std. Pk.
DIN Rail	2511120 CA701-15/S	20 20	2511120 CA701-15/S	20 20
End Clamp	CA702 CA802 CA103	50 50 50	CA702 CA802 CA103	50 50 50
Jumpers	JX6/2 JX6/3 JX6/4 JX6/10	100 50 50 10	JX6/2 JX6/3 JX6/4 JX6/10	100 50 50 10
Marking Tag	MT16	1 Pk. (100 tags)	MT16	1 Pk. (100 tags)

HIGHLIGHTS

FEATURES

- Hybrid Distribution Terminal Block
- Screw input (115A)
- 4 spring clamp outputs (4 x41A)
- Modular system
- Standard slot & hex screw versions
- Expandable with standard CX Series jumpers and terminal blocks
- Easy Installation

APPLICATIONS

- Miniature Circuit Breaker (MCB) distribution
- Limited space distribution

Output Expansion

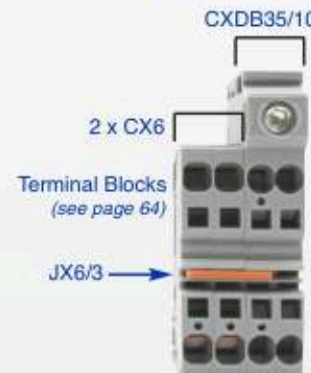

MCB Distribution Example



HIGHLIGHTS

FEATURES

- 3 Clamp Sizes
- Panel Mount
 - NES
 - NEB6
- DIN Rail Mount
 - CA202
 - NEB10
- Tin Plated Copper Busbars
- Busbar Current rating 140A
- Standard Color: Green
- Various colors

APPLICATIONS

- Grounding Solution
- Terminating Neutral an Grounding Wires to a single busbar
- Distribution Applications



Dimensions & Weight

	CENC4	CENC16	CENC35
Width	7.5 mm	9.8 mm	14.5 mm
Length	23.3 mm	23.3 mm	27.3 mm
Weight per piece	8 g	10.5 g	20 g

Technical Data/Ratings

Approvals	CENC4			CENC16			CENC35		
	CE	UL E220514	IEC 60947-7-2	UL E220514	UL E220514	IEC 60947-7-2	UL E220514	UL E220514	IEC 60947-7-2
Wire Size (solid / stranded)	22-12 AWG	22-12 AWG	0.2-6 mm ²	10-6 AWG	10-6 AWG	10-16 mm ²	8-2 AWG	8-2 AWG	10-35 mm ²
Voltage Rating	600 V	600 V	800 V	600 V	600 V	800 V	600 V	600 V	800 V
Current Rating	-	-	37 A	-	-	76 A	-	-	125 A
Torque	14 lb-in	14 lb-in	0.8 Nm	17.5 lb-in	17.5 lb-in	2.0 Nm	25 lb-in	25 lb-in	2.5 Nm
Insulation Material	Polyamide 66			Polyamide 66			Polyamide 66		

Installation Instructions

	CENC4	CENC16	CENC35
Wire Stripping Length	12 mm	16 mm	16 mm
Screwdriver	Flat Head 0.8 x 4 mm	Flat Head 1.0 x 5.5 mm	Flat Head 1.0 x 5.5 mm

Terminal Blocks

	Cat. No.	Std. Pk.	Cat. No.	Std. Pk.	Cat. No.	Std. Pk.
Green (standard)	CENC4	50	CENC16	50	CENC35	50
Black BL	CENC4/BL	50	CENC16/BL	50	CENC35/BL	50
Blue BU	CENC4/BU	50	CENC16/BU	50	CENC35/BU	50
Grey GR	CENC4/GR	50	CENC16/GR	50	CENC35/GR	50
Yellow Y	CENC4/Y	50	CENC16/Y	50	CENC35/Y	50

Mounting Accessories

Panel Mount

	Cat. No.	Std. Pk.	Cat. No.	Std. Pk.	Cat. No.	Std. Pk.
Busbar (6 x 6 mm)	NEB6	1 m	NEB6	1 m	NEB6	1 m
Plastic Support with Fixing Screw	NES	50	NES	50	NES	50
Marking Tag	MT5	1 Pk. (100 tags)	MT6	1 Pk. (100 tags)	MT6	1 Pk. (100 tags)

Mounting Accessories

DIN Rail Mount

	Cat. No.	Std. Pk.	Cat. No.	Std. Pk.	Cat. No.	Std. Pk.
Busbar (10 x 3 mm)	NEB10	1 m	NEB10	1 m	NEB10	1 m
End Clamp/Busbar support for rail mounting	CA202	50	CA202	50	CA202	50
Marking Tag	MT5	1 Pk. (100 tags)	MT6	1 Pk. (100 tags)	MT6	1 Pk. (100 tags)

Panel Mount Assembly Example

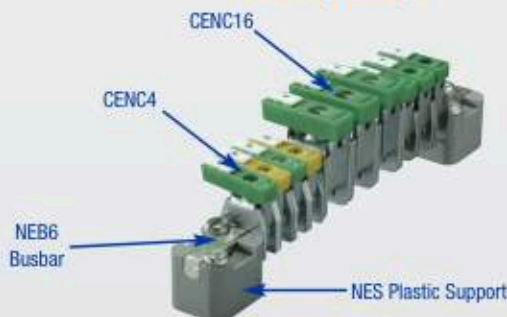

DIN Rail Mount Assembly Example



CHV4U

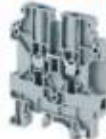

CHV6U

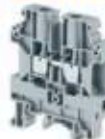

CHV10U



Dimensions & Weight

	6 mm	8 mm	10 mm
Width	6 mm	8 mm	10 mm
Length	52 mm	52 mm	52 mm
Height w/ DIN Rail	63.4 mm 70.8 mm	63.4 mm 70.8 mm	63.4 mm 70.8 mm
Weight per piece	11.0 g	16.0 g	21.6 g

Technical Data/Ratings

Approvals						
Wire Size (solid / stranded)	22-10 AWG / 0.2-4 mm ²		22-8 AWG / 0.2-6 mm ²		20-6 AWG / 0.2-10 mm ²	
Voltage Rating	1000 V / 1500 V AC/DC		1000 V / 1500 V AC/DC		1000 V / 1500 V AC/DC	
Current Rating	35 A / 32 A		50 A / 41 A		65 A / 57 A	
Torque	7 lb-in / 0.5 Nm		14 lb-in / 0.8 Nm		14 lb-in / 1.2 Nm	
Insulation Material	Polyamide 66					

Installation Instructions

Wire Stripping Length	12 mm	14 mm	14 mm
Screwdriver	Flat Head 0.6 x 3.5 mm	Flat Head 0.8 x 4 mm	Flat Head 0.8 x 4 mm

Terminal Blocks

	Cat. No.	Std. Pk.	Cat. No.	Std. Pk.	Cat. No.	Std. Pk.
Grey (standard)	CHV4U	50	CHV6U	50	CHV10U	50
Red R	CHV4U/R	50	CHV6U/R	50	CHV10U/R	50
Blue BU	CHV4U/BU	50	CHV6U/BU	50	CHV10U/BU	50
Black BL	CHV4U/BL	50	CHV6U/BL	50	CHV10U/BL	50
Orange O	CHV4U/O	50	CHV6U/O	50	CHV10U/O	50
Green G	CHV4U/G	50	CHV6U/G	50	CHV10U/G	50
Yellow Y	CHV4U/Y	50	CHV6U/Y	50	CHV10U/Y	50
White W	CHV4U/W	50	CHV6U/W	50	CHV10U/W	50

Accessories

	Cat. No.	Std. Pk.	Cat. No.	Std. Pk.	Cat. No.	Std. Pk.
End Plate	EPUSC	50	EPUSC	50	EPUSC	50
Separator Plate	SP2.5/4UN	50	SP2.5/4UN	50	SP2.5/4UN	50
DIN Rail	2511120 CA701-15/S 2511160	20 20 10	2511120 CA701-15/S 2511160	20 20 10	2511120 CA701-15/S 2511160	20 20 10
End Stop	CA702 CA802 CA202	50 50 25	CA702 CA802 CA202	50 50 25	CA702 CA802 CA202	50 50 25
Internal Jumper	CA623/2 CA623/3 CA623/4 CA623/10	100 100 100 10	CA624/2 CA624/3 CA624/4 CA624/10	100 100 100 10	CA625/2 CA625/3 CA625/4 CA625/10	100 100 100 10
Marking Tag	MT6	1 Pk. (100 tags)	MT8	1 Pk. (100 tags)	MT10	1 Pk. (100 tags)

HIGHLIGHTS

FEATURES

- High Voltage Terminal Blocks
- 1000V UL Rating
- 1500V IEC DC Rating
- Same Profile on all Current Ratings

APPLICATIONS

- Solar Applications
- High Voltage Applications

HIGHLIGHTS

FEATURES

- Thermocouple terminal blocks are used to extend thermocouple compensating lines in measuring circuits
- The current bar of the terminal block is made of the same material as the thermocouple wire (As per EN 60584/DINEN 60584)
- No loss of potential at the connection points
- Available types:
 - K Type** - Chromel (NiCr), Alumel (Ni)
 - J Type** - Iron (Fe), Constantan (CuNi)
 - T Type** - Copper (Cu), Constantan (CuNi)
 - E Type** - Chromel (NiCr), Constantan (CuNi)

APPLICATIONS

- Measurement applications

CTT2.5UK/J/T/E

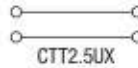

Dimensions & Weight

Width	10 mm	
Length	43 mm	
Height w DIN Rail	35 x 7.5 mm	46.2 mm
	35 x 15 mm	53.7 mm
Weight per piece	12.4 g	

Technical Data/Ratings

Approvals		
Wire Size (solid / stranded)	22-14 AWG	0.2-2.5 mm ²
Voltage Rating	1000 V AC/DC	
Current Rating	10 A	
Torque	7 b-in/ 0.4 Nm	
Insulation Material	Polyamide 66	

Installation Instructions

Wire Stripping Length	8 mm
Screwdriver	Flat Head 0.5 x 3 mm

Terminal Blocks

	Cat. No.	Std. Pk.
Grey		
U Type	CTT2.5UK	50
J Type	CTT2.5UJ	50
T Type	CTT2.5UT	50
G Type	CTT2.5UG	50

Accessories

	Cat. No.	Std. Pk.
End Plate	EP2.5/4UN	50
Partition Plate	PP2.5/4UN	50
DIN Rail	2511120	20
	CA701-15/S	20
	2511160	10
End Stop	CA702	100
	CA802	100
Marking Tag	INCLUDED	

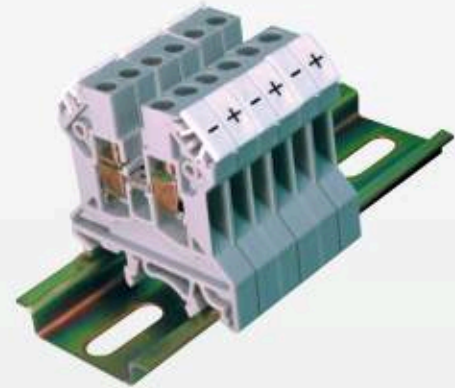

Typical Temperature Measuring Circuit

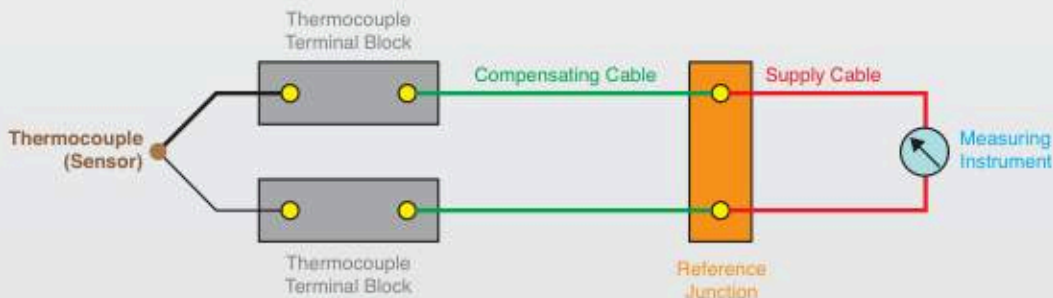

CTC4U



Dimensions & Weight

Width	6 mm
Length	47 mm
Height w DIN Rail	51.2 mm 58.8 mm
Weight per piece	8.0 g

Technical Data/Ratings

Approvals	
Wire Size (solid stranded)	0.2-4.0 mm ² 24-12 AWG
Voltage Rating	300 V
Current Rating	32 A
Tab (Blade) Size	6.3x0.8 mm
Insulation Material	Polyamide 66

Installation Instructions

Wire Stripping Length	9 mm
-----------------------	------

Terminal Blocks

	Cat. No.	Std. Pk.
Grey (standard)	CTC4U	100
Red R	CTC4U/R	100
Blue BU	CTC4U/BU	100
Black BL	CTC4U/BL	100
Orange O	CTC4U/O	100
Green G	CTC4U/G	100
Yellow Y	CTC4U/Y	100
White W	CTC4U/W	100

Accessories

	Cat. No.	Std. Pk.
End Plate	EPCTC4U	50
DIN Rail	2511120	20
	CA701-15/S	20
	2511160	10
End Stop	CA702	100
	CA802	100
Test Socket	CA707/TS/01	
Marking Tag	MT6	1 Pk. (100 tags)

HIGHLIGHTS

FEATURES

- Standard tab connection terminals
- Quick-Connect Tabs

APPLICATIONS

- Transportation
- Railroad Applications



SPRING LOADED

SCREW TERMINAL BLOCKS

FEED-THROUGH TERMINAL BLOCKS

HIGHLIGHTS

FEATURES

- Feed Through Terminals with Springs below clamps
- High torque screws
- Built-in springs guarantee secure connection even when screw is not tight
- 4 mm, 6 mm, 10mm terminal blocks with same size profile
- It is recommended to use hook type lugs/ ferrules for wire termination
- Both, high-torque screws and built-in spring
- Various disconnect terminals

APPLICATIONS

- Vibration Applications
- Projects which follow the following safety regulations:
 - Electric Supply Standard (ESI)
 - British CEGB Standard
 - NTPC standard

CTS4USC



CTS6USC



CTS10USC



Dimensions & Weight

	Feed Through Terminal Spring Loaded	Feed Through Terminal Spring Loaded	Feed Through Terminal Spring Loaded
Width	6 mm	8 mm	10 mm
Length	52 mm	52 mm	52 mm
Height w/ DIN Rail	35 x 7.5 mm 35 x 15 mm	63.4 mm 70.8 mm	63.4 mm 70.8 mm
Weight per piece	13.0 g	10.0 g	12.6 g

Technical Data/Ratings

Approvals						
Wire Size (solid / stranded)	22-10 AWG	0.2-4 mm ²	22-8 AWG	0.2-6 mm ²	20-6 AWG	0.2-10 mm ²
Voltage Rating	600 V	1500V AC/DC	1000 V	1500V AC/DC	1000 V	1500V AC/DC
Current Rating	35 A	32 A	50 A	41 A	65 A	57 A
Torque	7 lb-in	0.5 Nm	14 lb-in	0.8 Nm	14 lb-in	1.2 Nm
Insulation Material	Polyamide 66		Polyamide 66		Polyamide 66	

Installation Instructions

Wire Stripping Length	12 mm	14 mm	14 mm
Screwdriver	Flat Head 0.6 x 3.5 mm	Flat Head 0.8 x 4 mm	Flat Head 0.8 x 4 mm

Terminal Blocks

	Cat. No.	Std. Pk.	Cat. No.	Std. Pk.	Cat. No.	Std. Pk.
Grey (standard)	CTS4USC	50	CTS6USC	50	CTS10USC	50
Red R	CTS4USC/R	50	CTS6USC/R	50	CTS10USC/R	50
Blue BU	CTS4USC/BU	50	CTS6USC/BU	50	CTS10USC/BU	50
Black BL	CTS4USC/BL	50	CTS6USC/BL	50	CTS10USC/BL	50
Orange O	CTS4USC/O	50	CTS6USC/O	50	CTS10USC/O	50
Green G	CTS4USC/G	50	CTS6USC/G	50	CTS10USC/G	50
Yellow Y	CTS4USC/Y	50	CTS6USC/Y	50	CTS10USC/Y	50
White W	CTS4USC/W	50	CTS6USC/W	50	CTS10USC/W	50

Accessories

	Cat. No.	Std. Pk.	Cat. No.	Std. Pk.	Cat. No.	Std. Pk.
End Plate	EPUSC	50	EPUSC	50	EPUSC	50
Separator Plate	SP2.5/4UN	50	SP2.5/4UN	50	SP2.5/4UN	50
DIN Rail	2511120	20	2511120	20	2511120	20
	CA701-15/S	20	CA701-15/S	20	CA701-15/S	20
	2511160	10	2511160	10	2511160	10
End Stop	CA702	100	CA702	100	CA702	100
	CA802	50	CA802	50	CA802	50
	CA202	50	CA202	50	CA202	50
Hook Type	1.5 mm ²	CA604/1	100	CA604/1	100	CA604/1
Lug / Ferrule	2.5 mm ²	CA604/2	100	CA604/2	100	CA604/2
	4 mm ²	CA604/5	100	CA604/5	100	CA604/5
	6 mm ²	-	-	CA604/4	100	CA604/4
	10 mm ²	-	-	-	-	CA604/3
Pre Assembled Jumpers	2 pole	CA623/2	100	CA624/2	100	CA625/2
	3 pole	CA623/3	100	CA624/3	100	CA625/3
	4 pole	CA623/4	100	CA624/4	100	CA625/4
	10 pole	CA623/10	10	CA624/10	10	CA625/10
Marking Tag	MT6	1 Pk. (100 tags)	MT8	1 Pk. (100 tags)	MT10	1 Pk. (100 tags)

CKT4SPSC



CDS6U/SC



CDTTUSC



CDTTUFTSC



Dimensions & Weight

	Knife Disconnect Spring Loaded Terminal	Slider Disconnect Spring Loaded Terminal	Slider Disconnect Spring Loaded Terminal	Feed Through Terminal Same profile as CDTTUSC
Width	6 mm	8 mm	8 mm	8 mm
Length	58.5 mm	82 mm	63 mm	63 mm
Height w/ DIN Rail	35 x 7.5 mm 35 x 15 mm	46.0 mm 53.5 mm	51.0 mm 59.2 mm	58.7 mm 65.7 mm
Weight per piece	14.1 g	30.9 g	31.0 g	25.4 g

Technical Data/Ratings

Approvals								
Wire Size (solid / stranded)	24-10 AWG	0.2-4 mm ²	22-8 AWG	0.2-6 mm ²	16-8 AWG	1.5-10 mm ²	16-8 AWG	1.5-10 mm ²
Voltage Rating	600 V	1000V AC/DC	600 V	800V AC/DC	600 V	800V AC/DC	600 V	800V AC/DC
Current Rating	30 A	28 A	45 A	41 A	41 A	57 A	41 A	57 A
Torque	4.5 lb-in	0.5 Nm	14 lb-in	0.8 Nm	14 lb-in	1.2 Nm	14 lb-in	1.2 Nm
Insulation Material	Polyamide 66		Polyamide 66		Polyamide 66		Polyamide 66	

Installation Instructions

Wire Stripping Length	8 mm	10 mm	12 mm	12 mm
Screwdriver	Flat Head 0.6 x 3.5 mm	Flat Head 0.8 x 4 mm	Flat Head 1.0 x 5.5 mm	Flat Head 1.0 x 5.5 mm

Terminal Blocks

	Cat. No.	Std. Pk.	Cat. No.	Std. Pk.	Cat. No.	Std. Pk.	Cat. No.	Std. Pk.
Grey (standard)	CKT4SPSC	50	CDS6U/SC	50	CDTTUSC	50	CDTTUFTSC	50
Red R	CKT4SPSC/R	50	CDS6U/SC/R	50	CDTTUSC/R	50	CDTTUFTSC/R	50
Blue BU	CKT4SPSC/BU	50	CDS6U/SC/BU	50	CDTTUSC/BU	50	CDTTUFTSC/BU	50
Black BL	CKT4SPSC/BL	50	CDS6U/SC/BL	50	CDTTUSC/BL	50	CDTTUFTSC/BL	50
Orange O	CKT4SPSC/O	50	CDS6U/SC/O	50	CDTTUSC/O	50	CDTTUFTSC/O	50
Green G	CKT4SPSC/G	50	CDS6U/SC/G	50	CDTTUSC/G	50	CDTTUFTSC/G	50
Yellow Y	CKT4SPSC/Y	50	CDS6U/SC/Y	50	CDTTUSC/Y	50	CDTTUFTSC/Y	50
White W	CKT4SPSC/W	50	CDS6U/SC/W	50	CDTTUSC/W	50	CDTTUFTSC/W	50

Accessories

	Cat. No.	Std. Pk.	Cat. No.	Std. Pk.	Cat. No.	Std. Pk.	Cat. No.	Std. Pk.
End Plate	-	-	EPCDS6U	50	EPCDTTU	50	EPCDTTU	50
DIN Rail	2511120 CA701-15/S 2511160	20 20 10	2511120 CA701-15/S 2511160	20 20 10	2511120 CA701-15/S 2511160	20 20 10	2511120 CA701-15/S 2511160	20 20 10
End Stop	CA702 CA802 CA202	100 50 50	CA702 CA802 CA202	100 50 50	CA702 CA802 CA202	100 50 50	CA702 CA802 CA202	100 50 50
Pre Assembled Jumpers	CA722/2 CA722/3 CA722/4 CA722/10 CA722/100	100 100 100 10 10	CA723/2 CA723/3 CA723/4 CA723/10	100 50 50 10	- - - -	- - - -	- - - -	- - - -
Insulated Jumpers	CA742/2 CA742/3 CA742/4 CA742/10 CA742/100	100 100 100 10 10	- - - - -	- - - - -	- - - - -	- - - - -	- - - - -	- - - - -
External Jumpers	CA714/2 CA714/3 CA714/4 CA714/10	100 100 100 20	- - - -	- - - -	CA710/2 CA710/3 CA710/4 CA710/10	100 50 50 20	CA710/2 CA710/3 CA710/4 CA710/10	100 50 50 20
Shorting Plug	-	-	-	-	QJ8/2	25	-	-
Marking Tag	MT6	1 Pk. (100 tags)	MT8	1 Pk. (100 tags)	MT8	1 Pk. (100 tags)	MT8	1 Pk. (100 tags)

HIGHLIGHTS

FEATURES

- Various configurations of Electronic components soldered into **CDL4U** double level terminal block
- Various Diode / Resistor combinations
- 4 connection points for convenient wiring
- Terminal Block with open current bar **CDL4U(O)** can be individually soldered with electronic components
- Spacer **CDL4USP** can be used to cover overlapping components when soldered individually

APPLICATIONS

- Reverse polarity protection
- Lamp testing

CDL4U(E)D1/D2



CDL4U(E)D3



CDL4U(E)DD1/DD2

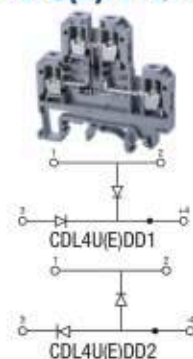

Dimensions & Weight

	Arc Suppression circuit diode for contactors and solenoid valves	Diode reverse polarity protection	Diode circuit for lamp testing
Width	6 mm	6 mm	6 mm
Length	55.5 mm	55.5 mm	55.5 mm
Height w DIN Rail	35 x 7.5 mm 35 x 15 mm	55.7 mm 63.1 mm	55.7 mm 63.1 mm
Weight per piece	13.6 g	13.4 g	13.4 g

Technical Data/Ratings

Approvals									
Wire Size (solid / stranded)	22-10 AWG 0.2-4 mm ²			22-10 AWG 0.2-4 mm ²			22-10 AWG 0.2-4 mm ²		
Voltage Rating	600 V	300 V	500 V AC	600 V	300 V	500 V AC	600 V	300 V	500 V AC
Current Rating	35 A	25 A	32 A	35 A	25 A	32 A	35 A	25 A	32 A
Torque	7 lb-in 0.5 Nm			7 lb-in 0.5 Nm			7 lb-in 0.5 Nm		
Insulation Material	Polyamide 66			Polyamide 66			Polyamide 66		

Electronic Component Specifications

Diode Type	1N 4007	1N 4007	1N 4007
Diode Reverse Voltage / Current	1000 V / 1 A	1000 V / 1 A	1000 V / 1 A
Indicator Voltage	-	-	-

Installation Instructions

Wire Stripping Length	9 mm	9 mm	9 mm
Screwdriver	Flat Head 0.6 x 3.5 mm	Flat Head 0.6 x 3.5 mm	Flat Head 0.6 x 3.5 mm

Terminal Blocks

	Cat. No.	Std. Pk.	Cat. No.	Std. Pk.	Cat. No.	Std. Pk.
Grey	CDL4U(E)D1	100	CDL4U(E)D3	100	CDL4U(E)DD1	100
	CDL4U(E)D2	100			CDL4U(E)DD2	100

Accessories

	Cat. No.	Std. Pk.	Cat. No.	Std. Pk.	Cat. No.	Std. Pk.
End Plate	EPCDL4U	50	EPCDL4U	50	EPCDL4U	50
Spacer	CDL4USP	50	CDL4USP	50	CDL4USP	50
DIN Rail	2511120	20	2511120	20	2511120	20
	CA701-15/S	20	CA701-15/S	20	CA701-15/S	20
	2511160	10	2511160	10	2511160	10
End Stop	CA702	50	CA702	50	CA702	50
	CA802	50	CA802	50	CA802	50
Internal Jumper	2 pole CA727/2	100	2 pole CA727/2	100	2 pole CA727/2	100
	3 pole CA727/3	100	3 pole CA727/3	100	3 pole CA727/3	100
	4 pole CA727/4	100	4 pole CA727/4	100	4 pole CA727/4	100
	10 pole CA727/10	10	10 pole CA727/10	10	10 pole CA727/10	10
	Marking Tag	MT2	1 Pk. (100 tags)	MT2	1 Pk. (100 tags)	MT2

CDL4U SPACER



Spacer to cover electronic components which stick out of CDL4U(O)

Cat. No.	Std. Pk.
CDL4USP	50

CDL4U(E)DD3/DD4



CDL4U(E)D4



CDL4U(E)DD5



Dimensions & Weight

	Diode circuit for lamp testing	Diode circuit for lamp testing with LED series resistance	Diode circuit for lamp testing with LED series resistance
Width	6 mm	6 mm	6 mm
Length	55.5 mm	55.5 mm	55.5 mm
Height w DIN Rail	35 x 7.5 mm 35 x 15 mm	55.7 mm 63.1 mm	55.7 mm 63.1 mm
Weight per piece	13.6 g	13.6 g	13.6 g

Technical Data/Ratings

Approvals									
	22-10 AWG			22-10 AWG			22-10 AWG		
Wire Size (solid / stranded)	0.2-4 mm ²			0.2-4 mm ²			0.2-4 mm ²		
Voltage Rating	600 V	300 V	500 V AC	600 V	300 V	500 V AC	600 V	300 V	500 V AC
Current Rating	35 A	25 A	32 A	35 A	25 A	32 A	35 A	25 A	32 A
Torque	7 lb-in		0.5 Nm	7 lb-in		0.5 Nm	7 lb-in		0.5 Nm
Insulation Material	Polyamide 66			Polyamide 66			Polyamide 66		

Electronic Component Specifications

Diode Type	1N 4007	1N 4007	1N 4007
Diode Reverse Voltage / Current	1000 V / 1 A	1000 V / 1 A	1000 V / 1 A
Indicator Voltage	-	-	-

Installation Instructions

Wire Stripping Length	9 mm	9 mm	9 mm
Screwdriver	Flat Head 0.6 x 3.5 mm	Flat Head 0.6 x 3.5 mm	Flat Head 0.6 x 3.5 mm

Terminal Blocks

	Cat. No.	Std. Pk.	Cat. No.	Std. Pk.	Cat. No.	Std. Pk.
Grey	CDL4U(E)DD3	100	CDL4U(E)D4/12V	100	CDL4U(E)DD5/12V	100
	CDL4U(E)DD4	100	CDL4U(E)D4/24V	100	CDL4U(E)DD5/24V	100

Accessories

	Cat. No.	Std. Pk.	Cat. No.	Std. Pk.	Cat. No.	Std. Pk.	
End Plate	EPCDL4U	50	EPCDL4U	50	EPCDL4U	50	
Spacer	CDL4USP	50	CDL4USP	50	CDL4USP	50	
DIN Rail	2511120	20	2511120	20	2511120	20	
	CA701-15/S	20	CA701-15/S	20	CA701-15/S	20	
	2511160	10	2511160	10	2511160	10	
End Stop	CA702	50	CA702	50	CA702	50	
	CA802	50	CA802	50	CA802	50	
Internal Jumper	2 pole	CA727/2	100	CA727/2	100	CA727/2	100
	3 pole	CA727/3	100	CA727/3	100	CA727/3	100
	4 pole	CA727/4	100	CA727/4	100	CA727/4	100
	10 pole	CA727/10	10	CA727/10	10	CA727/10	10
		CA727/10	10	CA727/10	10	CA727/10	10
Marking Tag	MT2	1 Pk. (100 tags)	MT2	1 Pk. (100 tags)	MT2	1 Pk. (100 tags)	

HIGHLIGHTS

FEATURES

- Various configurations of Electronic components soldered into **CDL4U** double level terminal block
- Various Indicator options
- AC voltage indicator
- DC voltage indicator
- LED and Neon lamp versions
- 4 connection points for convenient wiring
- Terminal Block with open current bar **CDL4U(O)** can be individually soldered with electronic components
- Spacer **CDL4USP** can be used to cover overlapping components when soldered individually

APPLICATIONS

- AC voltage indication
- DC voltage indication

CDL4U(E)N1

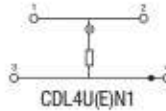

CDL4U(E)LD5

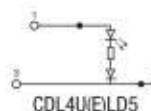

CDL4U(E)LD3

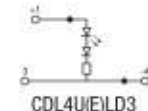

Dimensions & Weight

	AC Voltage indicator with Neon lamp	AC Voltage indicator with LED	AC Voltage indicator with LED
Width	6 mm	6 mm	6 mm
Length	55.5 mm	55.5 mm	55.5 mm
Height w DIN Rail	35 x 7.5 mm 35 x 15 mm	55.7 mm 63.1 mm	55.7 mm 63.1 mm
Weight per piece	13.6 g	12.4 g	12.4 g

Technical Data/Ratings

Approvals									
Wire Size (solid / stranded)	22-10 AWG 0.2-4 mm ²			22-10 AWG 0.2-4 mm ²			22-10 AWG 0.2-4 mm ²		
Voltage Rating	600 V	300 V	500 V AC	600 V	300 V	500 V AC	600 V	300 V	500 V AC
Current Rating	35 A	25 A	32 A	35 A	25 A	32 A	35 A	25 A	32 A
Torque	7 lb-in 0.5 Nm			7 lb-in 0.5 Nm			7 lb-in 0.5 Nm		
Insulation Material	Polyamide 66			Polyamide 66			Polyamide 66		

Electronic Component Specifications

Diode Type	1N 4007			1N 4007			1N 4007		
Diode Reverse Voltage / Current	1000 V / 1 A			1000 V / 1 A			1000 V / 1 A		
Indicator Voltage	110, 220 VAC			24, 48, 110, 220 VAC			12, 24 VAC		

Installation Instructions

Wire Stripping Length	9 mm			9 mm			9 mm		
Screwdriver	Flat Head 0.6 x 3.5 mm			Flat Head 0.6 x 3.5 mm			Flat Head 0.6 x 3.5 mm		

Terminal Blocks

	Cat. No.	Std. Pk.	Cat. No.	Std. Pk.	Cat. No.	Std. Pk.
Grey	CDL4U(E)N1/110V	100	CDL4U(E)LD5/24V	100	CDL4U(E)LD3/12V	100
	CDL4U(E)N1/220V	100	CDL4U(E)LD5/48V	100	CDL4U(E)LD3/24V	100
			CDL4U(E)LD5/110V	100		
			CDL4U(E)LD5/220V	100		

Accessories

	Cat. No.	Std. Pk.	Cat. No.	Std. Pk.	Cat. No.	Std. Pk.
End Plate	EPCDL4U	50	EPCDL4U	50	EPCDL4U	50
Spacer	CDL4USP	50	CDL4USP	50	CDL4USP	50
DIN Rail	2511120	20	2511120	20	2511120	20
	CA701-15/S	20	CA701-15/S	20	CA701-15/S	20
	2511160	10	2511160	10	2511160	10
End Stop	CA702	50	CA702	50	CA702	50
	CA802	50	CA802	50	CA802	50
Internal Jumper	2 pole CA727/2	100	2 pole CA727/2	100	2 pole CA727/2	100
	3 pole CA727/3	100	3 pole CA727/3	100	3 pole CA727/3	100
	4 pole CA727/4	100	4 pole CA727/4	100	4 pole CA727/4	100
	10 pole CA727/10	10	10 pole CA727/10	10	10 pole CA727/10	10
	Marking Tag	MT2	1 Pk. (100 tags)	MT2	1 Pk. (100 tags)	MT2

CDL4U(E)LD1/LD2



CDL4U(E)LD4

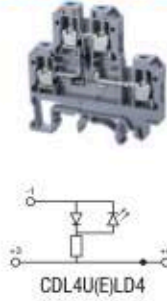

CDL4U(E)L1/L2



CDL4U(O)



Dimensions & Weight

Width	6 mm	6 mm	6 mm	6 mm
Length	55.5 mm	55.5 mm	55.5 mm	55.5 mm
Height w/ DIN Rail	35 x 7.5 mm 35 x 15 mm	55.7 mm 63.1 mm	55.7 mm 63.1 mm	55.7 mm 63.1 mm
Weight per piece	12.4 g	12.4 g	12.4 g	13.0 g

Technical Data/Ratings

Approvals												
Wire Size (solid / stranded)	22-10 AWG / 0.2-4 mm ²			22-10 AWG / 0.2-4 mm ²			22-10 AWG / 0.2-4 mm ²			22-10 AWG / 0.2-4 mm ²		
Voltage Rating	600 V	300 V	500 V AC	600 V	300 V	500 V AC	600 V	300 V	500 V AC	600 V	300 V	500 V AC
Current Rating	35 A	25 A	32 A	35 A	25 A	32 A	35 A	25 A	32 A	35 A	35 A	32 A
Torque	7 lb-in / 0.5 Nm			7 lb-in / 0.5 Nm			7 lb-in / 0.5 Nm			7 lb-in / 0.5 Nm		
Insulation Material	Polyamide 66											

Electronic Component Specifications

Diode Type	1N 4007	1N 4007	1N 4007	1N 4007
Diode Reverse Voltage / Current	1000 V / 1 A	1000 V / 1 A	1000 V / 1 A	1000 V / 1 A
Indicator Voltage	12, 24 VAC	24, 48 VAC	6, 24 VAC	-

Installation Instructions

Wire Stripping Length	9 mm	9 mm	9 mm	9 mm
Screwdriver	Flat Head 0.6 x 3.5 mm	Flat Head 0.6 x 3.5 mm	Flat Head 0.6 x 3.5 mm	Flat Head 0.6 x 3.5 mm

Terminal Blocks

Grey	Cat. No.	Std. Pk.	Cat. No.	Std. Pk.	Cat. No.	Std. Pk.	Cat. No.	Std. Pk.
	CDL4U(E)LD1/12V	100	CDL4U(E)LD4/24V	100	CDL4U(E)L1/6V	100	CDL4U(O)	100
	CDL4U(E)LD1/24V	100	CDL4U(E)LD4/48V	100	CDL4U(E)L1/24V	100		
	CDL4U(E)LD2/12V	100			CDL4U(E)L2/6V	100		
	CDL4U(E)LD2/24V	100			CDL4U(E)L2/24V	100		

Accessories

End Plate	Cat. No.	Std. Pk.	Cat. No.	Std. Pk.	Cat. No.	Std. Pk.	Cat. No.	Std. Pk.
	EPCDL4U	50	EPCDL4U	50	EPCDL4U	50	EPCDL4U	50
Spacer	CDL4USP	50	CDL4USP	50	CDL4USP	50	CDL4USP	50
DIN Rail	2511120	20	2511120	20	2511120	20	2511120	20
	CA701-15/S	20	CA701-15/S	20	CA701-15/S	20	CA701-15/S	20
	2511160	10	2511160	10	2511160	10	2511160	10
End Stop	CA702	50	CA702	50	CA702	50	CA702	50
	CA802	50	CA802	50	CA802	50	CA802	50
Internal Jumper	CA727/2	100	CA727/2	100	CA727/2	100	CA727/2	100
	CA727/3	100	CA727/3	100	CA727/3	100	CA727/3	100
	CA727/4	100	CA727/4	100	CA727/4	100	CA727/4	100
	CA727/10	10	CA727/10	10	CA727/10	10	CA727/10	10
Marking Tag	MT2	1 Pk. (100 tags)	MT2	1 Pk. (100 tags)	MT2	1 Pk. (100 tags)	MT2	1 Pk. (100 tags)

HIGHLIGHTS

FEATURES

- Various solutions to protect single lines against surges
- Lightning Arrestors (CDL4U(E)LA)
- MOVs (CDL4U(E)MOV)
- RC Circuits (CDL4U(E)RC)
- Suppressor Diode (CDL4U(E)SD)

APPLICATIONS

- Surge suppressor applications
- Equipment protection

CDL4U(E)LA

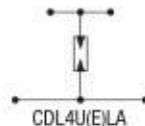

CDL4U(E)LA

CDL4U(E)3LA

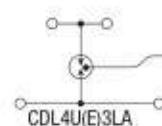

CDL4U(E)3LA

CDL4U(E)RC

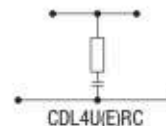

CDL4U(E)RC



Dimensions & Weight

	CDL4U(E)LA	CDL4U(E)3LA	CDL4U(E)RC
Width	18 mm	18 mm	18 mm
Length	55.5 mm	55.5 mm	55.5 mm
Height w DIN Rail	35 x 7.5 mm 35 x 15 mm	55.7 mm 63.1 mm	55.7 mm 63.1 mm
Weight per piece	30.0 g	34.2 g	22.4 g

Technical Data/Ratings / Component Specifications

	CDL4U(E)LA	CDL4U(E)3LA	CDL4U(E)RC
Wire Size (solid / stranded)	22-10 AWG	22-10 AWG	22-10 AWG
Insulation Material	Polyamide 66	Polyamide 66	Polyamide 66
Nominal Current	10 A	5 A	-
Peak Current	-	-	2kA-6.5kA (8/20µs)
Nominal Discharge Current	20 KA (8/20µs)	10 KA (8/20µs)	-
Response Time	100 ns	100 ns	< 25 ns
Capacitance	< 1.5 pf	< 1.0 pf	100 - 20,000 pf
Voltage Rating	75, 90, 230, 600, 1000 V DC	90, 230, 350, 600 V DC	30, 60, 75, 130, 275, 460, 510, 625, 680 V AC

Installation Instructions

	CDL4U(E)LA	CDL4U(E)3LA	CDL4U(E)RC
Wire Stripping Length	9 mm	9 mm	9 mm
Screwdriver	Flat Head 0.6 x 3.5 mm	Flat Head 0.6 x 3.5 mm	Flat Head 0.6 x 3.5 mm

Terminal Blocks

	Cat. No.	Std. Pk.	Cat. No.	Std. Pk.	Cat. No.	Std. Pk.
Grey	CDL4U(E)LA/75V	20	CDL4U(E)3LA/90V	20	0.1 µF	
	CDL4U(E)LA/90V	20	CDL4U(E)3LA/230V	20	CDL4U(E)RC0.1	10
	CDL4U(E)LA/230V	20	CDL4U(E)3LA/350V	20		
	CDL4U(E)LA/600V	20	CDL4U(E)3LA/600V	20	0.22 µF	
	CDL4U(E)LA/1000V	20			CDL4U(E)RC0.22	10

Accessories

	Cat. No.	Std. Pk.	Cat. No.	Std. Pk.	Cat. No.	Std. Pk.
End Plate	EPCDL4U	50	EPCDL4U	50	EPCDL4U	50
Spacer	CDL4USP	50	CDL4USP	50	CDL4USP	50
DIN Rail	2511120	20	2511120	20	2511120	20
	CA701-15/S	20	CA701-15/S	20	CA701-15/S	20
	2511160	10	2511160	10	2511160	10
End Stop	CA702	50	CA702	50	CA702	50
	CA802	50	CA802	50	CA802	50
Marking Tag	MT2	1 Pk. (100 tags)	MT2	1 Pk. (100 tags)	MT2	1 Pk. (100 tags)

CDL4U(E)MOV

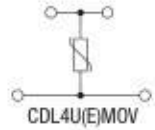

CTLG2.5(E)MOV



CDL4U(E)SD

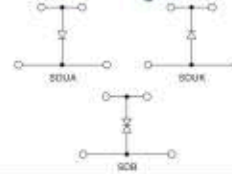

Dimensions & Weight

Width	12 mm	6 mm	12 mm
Length	55.5 mm	87.5 mm	55.5 mm
Height w DIN Rail	35 x 7.5 mm 35 x 15 mm	55.7 mm 63.1 mm	55.7 mm 63.1 mm
Weight per piece	19.2 g	14.8 g	18.0 g

Technical Data/Ratings / Component Specifications

Wire Size (solid / stranded)	22-10 AWG	22-10 AWG	22-10 AWG
Insulation Material	Polyamide 66	Polyamide 66	Polyamide 66
Nominal Current	-	5 A	-
Peak Current	2kA-6.5kA (8/20µs)	2kA-6.5kA (8/20µs)	-
Nominal Discharge Current	-	10 KA (8/20µs)	1.5 KA
Response Time	< 25 ns	< 25 ns	1 ns (D.C) / 5 ns (A.C)
Capacitance	100 - 20,000 pf	100 - 20,000 pf	-
Voltage Rating	30, 60, 75, 130, 275, 460, 510, 625, 680 V AC	Up to 275V	30, 60, 75, 130, 275, 460, 510, 625, 680 V AC

Installation Instructions

Wire Stripping Length	9 mm	9 mm	9 mm
Screwdriver	Flat Head 0.6 x 3.5 mm	Flat Head 0.6 x 3.5 mm	Flat Head 0.6 x 3.5 mm

Terminal Blocks

	Cat. No.	Std. Pk.	Cat. No.	Std. Pk.	Cat. No.	Std. Pk.
Grey	CDL4U(E)MOV30V	20	CTLG2.5(E)MOV30V	20	DC - Anode	
	CDL4U(E)MOV60V	20	CTLG2.5(E)MOV60V	20	CDL4U(E)SDUA12VDC	20
	CDL4U(E)MOV75V	20	CTLG2.5(E)MOV75V	20	CDL4U(E)SDUA24VDC	20
	CDL4U(E)MOV130V	20	CTLG2.5(E)MOV130V	20	CDL4U(E)SDUA48VDC	20
	CDL4U(E)MOV275V	20	CTLG2.5(E)MOV275V	20	DC - Cathode	
	CDL4U(E)MOV460V	20			CDL4U(E)SDUK12VDC	20
	CDL4U(E)MOV510V	20			CDL4U(E)SDUK24VDC	20
	CDL4U(E)MOV625V	20			CDL4U(E)SDUK48VDC	20
	CDL4U(E)MOV680V	20			AC	
					CDL4U(E)SDB12VAC	
				CDL4U(E)SDB24VAC		
				CDL4U(E)SDB48VAC		
				CDL4U(E)SDB160VAC		

Accessories

	Cat. No.	Std. Pk.	Cat. No.	Std. Pk.	Cat. No.	Std. Pk.
End Plate	EPCDL4U	50	EPCTLG2.5	50	EPCDL4U	50
Spacer	CDL4USP	50	-	-	CDL4USP	50
DIN Rail	2511120 CA701-15/S 2511160	20 20 10	2511120 CA701-15/S 2511160	20 20 10	2511120 CA701-15/S 2511160	20 20 10
End Stop	CA702 CA802	50 50	CA702 CA802	50 50	CA702 CA802	50 50
Marking Tag	MT2	1 Pk. (100 tags)	MT2	1 Pk. (100 tags)	MT2	1 Pk. (100 tags)

ACCESSORIES

SCREW TERMINAL BLOCKS

JUMPER / SHORTING LINKS

Internal Jumper



Insulated Internal Jumper



External Jumper



Current Bar



Shorting Sleeve & Screws



	Poles	Cat. No.	Std. Pk.	Cat. No.	Std. Pk.	Cat. No.	Std. Pk.	Cat. No.	Std. Pk.	Cat. No.	Std. Pk.
CTS2.5U-N	2 Pole	CA721/2	100	CA741/2	100	CA717/2	100	CA703/01	100	CA707/S/Q/01	100
	3 Pole	CA721/3	100	CA741/3	100	CA717/3	100	CA704/01	100		
	4 Pole	CA721/4	100	CA741/4	100	CA717/4	100	CA705/01	100		
	10 Pole	CA721/10	10	CA741/10	10	CA717/10	20	CA731/10	100		
	100 Pole	CA721/100	10	CA741/100	10	-	-	CA731/100	10		
CTS4U-N, CCC4U, CMC1-2, CMC2-2, CDL4UN, CDL4U(I.S) CDLG4, CDLG(I.S), CF4SP, CF4SP(L), CKT4U ¹ , CKT4SP	2 Pole	CA722/2	100	CA742/2	100	CA714/2	100	CA703/1	100	CA707/S/Q/01	100
	3 Pole	CA722/3	100	CA742/3	100	CA714/3	100	CA704/1	100		
	4 Pole	CA722/4	100	CA742/4	100	CA714/4	100	CA705/1	100		
	10 Pole	CA722/10	10	CA742/10	10	CA714/10	20	CA732/10	100		
	100 Pole	CA722/100	10	CA742/100	10	-	-	CA732/100	10		
CTS6U, CDS6U CDTTU ¹ , CDTTU-SH ¹	2 Pole	CA723/2	100	CA743/2	100	CA710/2	100	CA703/2	100	CA707/S/Q/1	100
	3 Pole	CA723/3	50	CA743/3	50	CA710/3	50	CA704/2	100		
	4 Pole	CA723/4	50	CA743/4	50	CA710/4	50	CA705/2	100		
	10 Pole	CA723/10	10	CA743/10	10	CA710/10	20	CA733/10	10		
CTS10U	2 Pole	CA724/2	100	CA744/2	100	CA718/2	100	CA703/3	100	CA707/S/Q/1	100
	3 Pole	CA724/3	50	CA744/3	50	CA718/3	50	CA704/3	100		
	4 Pole	CA724/4	50	CA744/4	50	CA718/4	50	CA705/3	100		
	10 Pole	CA724/10	10	CA744/10	10	CA718/10	20	CA734/10	10		
CTS16U	2 Pole	CA751/2	50	CA761/2	50	-	-	CA703/8	100	CA707/S/Q/1	100
	3 Pole	CA751/3	50	CA761/3	50	-	-	CA704/8	100		
	4 Pole	CA751/4	50	CA761/4	50	-	-	CA705/8	100		
	10 Pole	CA751/10	10	CA761/10	10	-	-	CA739/10	10		
CTS25UN	2 Pole	CA725/2	50	CA745/2	50	-	-	CA703/4	100	CA707/S/Q/2	100
	3 Pole	CA725/3	20	CA745/3	20	-	-	CA704/4	100		
	4 Pole	CA725/4	20	CA745/4	20	-	-	CA705/4	100		
	10 Pole	CA725/10	10	CA745/10	10	-	-	CA735/10	100		
CTS35UN	2 Pole	CA771/2	50	CA781/2	50	-	-	CA703/10	100	CA707/S/Q/2	100
	3 Pole	CA771/3	20	CA781/3	20	-	-	CA704/10	100		
	4 Pole	CA771/4	20	CA781/4	20	-	-	CA705/10	100		
	10 Pole	CA771/10	10	CA781/10	10	-	-	CA770/10	10		
CTS50/70N	2 Pole	CA628/2	10	-	-	-	-	-	-	-	-
	3 Pole	CA628/3	10	-	-	-	-	-	-	-	-
CTS95/120N	2 Pole	CA629/2	10	-	-	-	-	-	-	-	-
	3 Pole	CA629/3	10	-	-	-	-	-	-	-	-
CTL2.5U, CTL2.5U(L) CTL2.5U-H, CTL2.5U-H(L) CTL2.5U(I.S)	2 Pole	CA722/2	100	-	-	CA715/2	100	CA703/1	100	CA707/S/Q/01	100
	3 Pole	CA722/3	100	-	-	CA715/3	100	CA704/1	100		
	4 Pole	CA722/4	100	-	-	CA715/4	100	CA705/1	100		
	10 Pole	CA722/10	10	-	-	CA715/10	20	CA732/10	100		
	100 Pole ²	CA722/100	10	-	-	-	-	CA732/100	10		
ODL4U CDL4U(E) CMT4 CMB4	2 Pole	CA727/2	100	CA747/2	100	CA714/2	100	CA703/1	100	CA607/S/Q	100
	3 Pole	CA727/3	100	CA747/3	100	CA714/3	100	CA704/1	100		
	4 Pole	CA727/4	100	CA747/4	100	CA714/4	100	CA705/1	100		
	10 Pole	CA727/10	10	CA747/10	10	CA714/10	20	CA732/10	100		
	100 Pole ²	CA727/100	10	CA747/100	10	-	-	CA732/100	10		
CDLG2.5 CTLG2.5	2 Pole	CA627/2	100	-	-	CA715/2	100	CA703/1	100	CA611/S/Q	100
	3 Pole	CA627/3	100	-	-	CA715/3	100	CA704/1	100		
	4 Pole	CA627/4	100	-	-	CA715/4	100	CA705/1	100		
	10 Pole	CA627/10	10	-	-	CA715/10	20	CA732/10	10		
CF4U ¹ CF4U(L) ¹	2 Pole	-	-	-	-	CA711/2	100	-	-	-	-
	3 Pole	-	-	-	-	CA711/3	50	-	-	-	-
	4 Pole	-	-	-	-	CA711/4	50	-	-	-	-
	10 Pole	-	-	-	-	CA711/10	20	-	-	-	-
DDFL4U, DDFL4U(E) DDFL4ULR, DDFL4ULR(E) CSDL4U ¹ , DDDL4U	2 Pole	CA729/2	100	CA749/2	100	CA711/2	100	CA703/6	100	CA707/S/Q/3	100
	3 Pole	CA729/3	50	CA749/3	50	CA711/3	50	CA704/6	100		
	4 Pole	CA729/4	50	CA749/4	50	CA711/4	50	CA705/6	100		
	10 Pole	CA729/10	10	CA749/10	10	CA711/10	20	CA737/10	100		
CAFL4U ¹ CAFL4U(L) ¹ CAFL4U(N) ¹	2 Pole	-	-	-	-	CA716/2	50	-	-	-	-
	3 Pole	-	-	-	-	CA716/3	50	-	-	-	-
	4 Pole	-	-	-	-	CA716/4	50	-	-	-	-
	10 Pole	-	-	-	-	CA716/10	20	-	-	-	-
CHV4U CTS4USC	2 Pole	CA623/2	100	-	-	-	-	-	-	-	-
	3 Pole	CA623/3	100	-	-	-	-	-	-	-	-
	4 Pole	CA623/4	100	-	-	-	-	-	-	-	-
	10 Pole	CA623/10	10	-	-	-	-	-	-	-	-
CHV6U CTS6USC	2 Pole	CA624/2	100	-	-	-	-	-	-	-	-
	3 Pole	CA624/3	100	-	-	-	-	-	-	-	-
	4 Pole	CA624/4	100	-	-	-	-	-	-	-	-
	10 Pole	CA624/10	10	-	-	-	-	-	-	-	-
CHV10U CTS10USC	2 Pole	CA625/2	100	-	-	-	-	-	-	-	-
	3 Pole	CA625/3	100	-	-	-	-	-	-	-	-
	4 Pole	CA625/4	100	-	-	-	-	-	-	-	-
	10 Pole	CA625/10	10	-	-	-	-	-	-	-	-

¹ Internal shorting system not available.

² 100 pole strip is breakable into any number of poles needed.

ENDPLATES



Terminal Block	Cat. No.	Dimensions	Std. Pk.
CTS2.5U-N, CTS4U-N	EP2.5/4UN	32 x 39 x 1.5mm	50
CTT2.5UK/J/T/E	EP6/10U	31 x 42.5 x 1.5mm	50
CCTS6U, CTS10U	EP6/10U	31 x 42.5 x 1.5mm	50
CMC1-2	EPCMC1-2	35.5 x 46.5 x 2.5mm	50
CMC2-2, CMCG4	EPCMC2-2	40.5 x 65 x 2.5mm	50
CDL4UN, CDLG4	EPCDL4UN	47.5 x 57 x 1.5mm	50
CDLG2.5	EPCDLG2.5	48 x 71.4 x 1.2mm	50
CTLG2.5	EPCTLG2.5	62.5 x 87.5 x 1.2mm	50
ODL4U	EP0DL4U (Front) EP10DL4U (Back)	49 x 86 x 5.5mm 24 x 68 x 3mm	50 50
CHV Series, CTSUSC Series	EPUSC	52 x 48.5 x 1.5mm	50
CTL2.5U Series	EPCTL2.5U	55.5 x 84 x 1.5mm	50
CTL2.5U-H Series	EPCTL2.5U-H	55.5 x 61 x 1.5mm	50
CAFL4U Series	EPCAF4U	32 x 72 x 1.5mm	50
CDS6U	EPCDS6U	37.2 x 82 x 1.5mm	50
CKT4U	EPCKT4U	30.5 x 46.5 x 2.5mm	50
EPCKT4U	EPCKT4U/4	65 x 38.3 x 1.5mm	50
CDTTU Series	EPCDTTU	41 x 63 x 3mm	50
CSDL4U	EPCSDL4U	28 x 55.5 x 1.6mm	50
DDDL4U, DDFL4U	EPDDL4U	49 x 87.6 x 3mm	50
CDL4U(E)	EPCDL4U	43 x 55 x 2.4mm	50
CTC4U	EPCTC4U	34.5 x 47 x 2.5mm	50
CMT4	EPCMT4	23 x 27 x 1.5mm	50
CMB4	EPCMB4	27 x 27 x 7mm	50
ODL2.5 Series	EP0DL2.5 EP10DL2.5	49 x 59 x 4.6mm 23 x 59 x 2.5mm	50 50

PARTITION PLATES



Terminal Block	Cat. No.	Dimensions	Std. Pk.
CTS2.5U-N, CTS4U-N	PP2.5/4UN	37 x 44 x 1.6mm	50
CTT2.5UK/J/T/E	PP6/10U	37.5 x 56 x 1.5mm	50
CTS6U, CTS10U	PP6/10U	37.5 x 56 x 1.5mm	50
CTS25UN	PP25UN	42.5 x 62 x 1mm	50
CTS35UN	PP35UN	50 x 64.5 x 1mm	50
CMT4	PPCMT4	32 x 37 x 1.6mm	50

SEPARATOR PLATES



Terminal Block	Cat. No.	Dimensions	Std. Pk.
CTS2.5U-N, CTS4U-N	SP2.5/4UN	17.5 x 17.4 x 1.4mm	100
CTT2.5UK/J/T/E	SP6/10U	15.4 x 16.2 x 1.5mm	100
CTS6U, CTS10U, CTS16U	SP6/10U	15.4 x 16.2 x 1.5mm	100
CSL4UN, CDL4UN(I.S.)	SPCDL4U	15.4 x 16.2 x 1.6mm	100
CBM4	SPCMB4	14.5 x 12 x 1.5mm	100
CDLG2.5	SPCDLG2.5	11 x 10.5 x 1	100

END STOPS

CA202



CA802



CA702



CA102



Cat. No.	Dimensions	Std. Pk.	Cat. No.	Dimensions	Std. Pk.	Cat. No.	Dimensions	Std. Pk.	Cat. No.	Dimensions	Std. Pk.
CA202	44.5 x 50 x 9.5mm	50	CA802	45 x 32 x 8mm	50	CA702	34 x 45 x 9mm	50	CA102	80 x 46 x 9mm	50

PROTECTIVE COVER

CTSPC COVER



SUPPORT PLATE



Cat. No.	Length	Std. Pk.
CTSPC/40	40mm	2
CTSPC/90	90mm	2
CTSPC/100	100mm	2
CTSPC/130	130mm	2
CTSPC/150	150mm	2
CTSPC/200	200mm	2
CTSPC/300	300mm	2
CTSPC/330	330mm	2

Cat. No.	Std. Pk.
CSP1	50

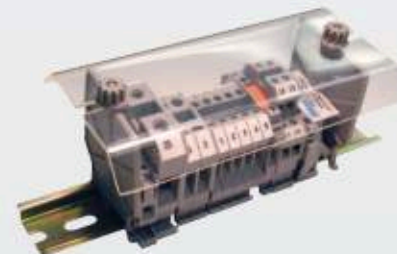

Assembled Block installed with Protective Cover